



**COLOR ECHO SOUNDER**

**ES-675**

**OPERATION MANUAL**

**SUZUKI FISH FINDER CO., LTD.**

12-1 MAMIZUKA, TOYOHASHI  
AICHI 441-8007, JAPAN

PHONE: (81) 532-32-7511 FAX: (81) 532-32-7500  
<http://www.suzukiff.co.jp/> [sales@suzukiff.co.jp](mailto:sales@suzukiff.co.jp)

## **INTRODUCTION**

***Thank you for purchasing the SUZUKI ES-675 Echo Sounder.  
We are confident you will enjoy using your unit for many years to come.***

Before attempting to operate this equipment, read this instruction manual thoroughly to ensure correct and safe operation in accordance with the warning instructions and operation procedures.

You are strongly recommended to store this instruction manual carefully for future reference. In the event that you have an operational problem or malfunction, this manual will provide useful instructions.



## **SAFETY INSTRUCTION**

---

### **SYMBOLS**

The following symbols are used in this manual.

Please read this manual carefully and take note of these symbols.

 <b>DANGER</b>	: indicates an imminently hazardous situation which, if not avoided, will result in death or serious injury.
 <b>WARNING</b>	: indicates a potentially hazardous situation which, if not avoided, could result in death or serious injury.
 <b>CAUTION</b>	: indicates a potentially hazardous situation which, if not avoided, may result in minor injury.
<b>NOTE !</b>	: indicates the contents for the user's reference.
<b>CF</b>	: Pages for the user's reference.

### **NOTICE**

This manual should be kept on hand to provide your quick reference whenever you need it.

Any use other than that mentioned in this manual is not guaranteed.

The contents of this manual and equipment specifications are subject to change without notice.

No part of this manual may be copied or reproduced without written permission.

## **INSTALLATION SITE REQUIREMENTS**



Keep the unit away from the flammable gas. Otherwise it causes a fire.



Follow the below proposed conditions for the installation. Otherwise it causes a fire, serious injury, and an electrical shock.

Away as much as possible from areas where the unit is likely to be exposed to direct water spray and free as much as possible from shocks and engine vibration.

Away as much as possible from areas of high temperatures or areas where the unit is likely to be exposed to direct sunlight.

## **MOUNTING CONDITIONS**



Do not install the unit on unstable or uneven surfaces. Installing the unit tentatively may result in dropping, toppling over or injury.

Follow the below conditions for wirings. Otherwise it causes heat, a fire, and injury.

Run the cables not to touch the rotary obstacles or disturb the operation.

Do not use the cables bent, twisted or stretched by force.

Do not put heavy objects on the cables.



Always turn off the power before connecting or disconnecting the unit.

Pulling the cables may damage the cables themselves and result in fire or an electrical shock.

## **FOR YOUR SAFETY**

---

### **POWER SUPPLY**



Operating voltage: 10.5 to 30 volts DC.  
Use the proper voltage. Otherwise it will result in fire and electrical shock.



Turn on/off the power by ON/OFF keys on the control panel. Turning on/off the power by the switchboard may damage the unit.

Turn off the power when starting the vessel engine. Otherwise it could result in serious trouble and damage the unit.

### **HANDLING**



Do not operate the unit while steering.  
Otherwise it will cause wrecks and injury.

Do not open the case cover.  
There is a risk of electrical shock if you touch the high voltage conductors.  
Only qualified personnel should work inside the unit.

Care for sufficient reinforcement and being watertight should be taken when installing the transducer.  
If not, serious leaks may result.



Use the proper fuse when changed.  
Otherwise it could result in serious trouble and fire.

Use the specified power supply cables.  
Otherwise it could result in serious trouble and fire.

## **HANDLING BATTERIES**



Insert new batteries, when replacing it.

Be sure that the batteries' polarity is correct.

Never subject batteries to very hot or cold temperatures, or disassemble or dump into fire/water.

Do not use batteries with fluid leaking out.

## **TFT LCD**

The high quality TFT (Thin Film Transistor) LCD displays 99.99% of its picture elements. The remaining 0.01% may drop out or light, however this is an inherent property of the LCD; it is not a sign of malfunction.

## CONTENTS

INTRODUCTION .....	1
SAFETY INSTRUCTION .....	2
FOR YOUR SAFETY .....	3
DISPLAY .....	7
CONTROL PANEL .....	8
KEY OPERATION .....	9
1. POWER ON .....	9
2. POWER OFF .....	9
3. AUTO RANGE .....	9
4. AUTO SHIFT .....	9
5. DISPLAY MODE .....	10
6. RANGE .....	10
7. PHASED RANGE .....	10
8. BOTTOM EXPANSION MODE .....	11
9. SHALLOW ALARM .....	11
10. DEEP ALARM .....	11
11. ALARM ON / OFF .....	12
12. THRESHOLD .....	12
13. PICTURE SPEED .....	12
14. MENU .....	13
15. GAIN .....	13
16. INTERFERENCE REDUCTION .....	13
17. ENTER .....	13
18. GAIN CONTROL .....	14
19. BRIGHTNESS CONTROL .....	14
USER SETTING UP .....	15
1. MAIN MENU .....	15
2. FUNCTION SET .....	16
3. REDUCTION .....	19
4. DISPLAY ITEM SELECTION .....	21
5. OTHERS .....	25
6. LANGUAGE .....	29
COLOR PRESENTATION .....	30
SIMULATION MODE .....	30
MENU TREE .....	31
INITIAL SETTINGS .....	32
INSTALLATION .....	33
CLEANING & DISPOSAL .....	37
SPECIFICATIONS .....	38

**DISPLAY**

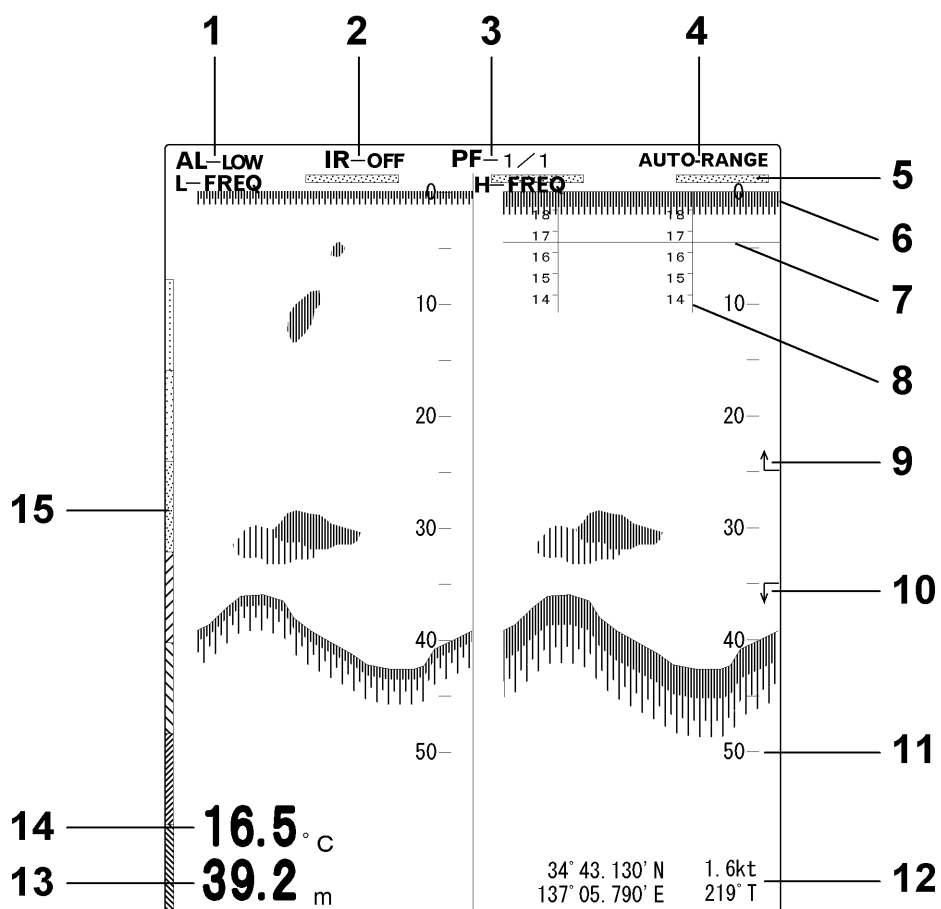

No.	Name
1	Alarm
2	Interference Reduction
3	Picture Speed
4	Auto Range / Auto Shift
5	Time Maker
6	Display Start Point (Transducer's Position)
7	Water Temperature Graph*
8	Water Temperature Scale*
9	Shallow Alarm Marker
10	Deep Alarm Marker
11	Depth Scale
12	Latitude*, Longitude*, Speed*, Course*
13	Depth
14	Water Temperature*
15	Color Scale

*\*Optional equipment is required.*

## CONTROL PANEL

### CONTROL PANEL

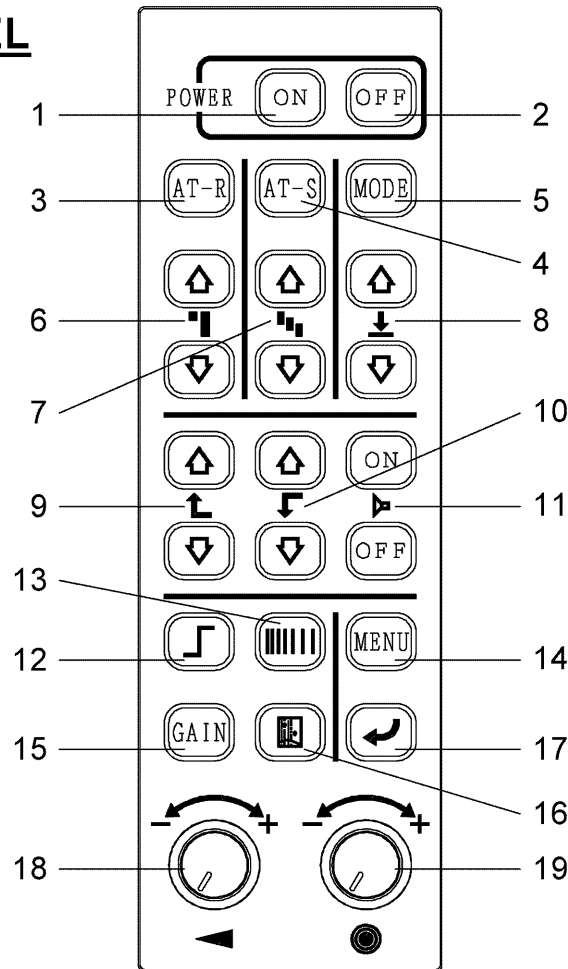

No.	Name	Function
1	POWER ON	Switches on
2	POWER OFF	Switches off
3	AT-R	Starts the auto range
4	AT-S	Starts the auto shift
5	MODE	Selects the display mode
6	RANGE KEYS	Selects the basic range
7	PHASED RANGE KEYS	Adjusts the scale/range of depth
8	BOTTOM EXPANSION KEYS	Selects the bottom expansion range
9	SHALLOW ALARM KEYS	Moves the shallow alarm marker
10	DEEP ALARM KEYS	Moves the deep alarm marker
11	ALARM ON / OFF	Sets the alarm ON/OFF
12	THRESHOLD KEY	Eliminates the unwanted echoes from the screen
13	PICTURE SPEED KEY	Selects the rate of picture movement
14	MENU	Opens the main menu
15	GAIN	Displays the gain level scale
16	INTERFERENCE REDUCTION KEY	Reduces interference from nearby vessels
17	ENTER KEY	Confirms menu selection
18	GAIN DIAL	Adjusts the receiver sensitivity
19	BRIGHTNESS DIAL	Adjusts the screen brilliance

## **KEY OPERATION**

One beep will advise you when a right operation is performed.

Three beeps will advise you when a wrong operation or a wrong key is pressed.

### **1. POWER ON**

Keep pressing POWER **ON** for one second to turn on the unit.

### **2. POWER OFF**

Keep pressing POWER **OFF** for three seconds to turn off the unit.

### **3. AUTO RANGE**

The range will change automatically to always show the full depth from transducer face to sea bottom regardless of changes in depth.

Press **AT-R** to start the auto range function.

When this function is activated, "AUTO-RANGE" will be displayed in the right of the top screen.

Press **RANGE KEY** to stop the auto range function.

### **4. AUTO SHIFT**

The phased range will change automatically to always track the bottom in the specified range.

Press **AT-S** to start the auto shift function.

When this function is activated, "AUTO-SHIFT" will be displayed in the right of the top screen.

Press **PHASED RANGE KEY** to stop the auto shift function.

## **KEY OPERATION**

---

### **5. DISPLAY MODE**

Selects one of the following modes.

#### ***Single Frequency Mode***

Either high frequency display or low frequency display is presented on a full screen.

#### ***Dual Frequency Mode***

The screen is vertically divided into two and the high frequency display and the low frequency display are presented on the same screen.

Each press of **MODE** changes the display mode.

### **6. RANGE**

The displayed range can be selected 0 to 5 and going to 1000m, fm, br. (0 to 15 and going to 3000ft.)

Use **RANGE KEYS** to select a specific range.

### **7. PHASED RANGE**

This function may be used to show the desired area expanded on the screen.

When **(PHASED RANGE) ↑** is pressed, the display of start depth will become shallower.

When **(PHASED RANGE) ↓** is pressed, the display of start depth will become deeper.

The desired area can be expanded by pressing **RANGE KEY**.

## 8. BOTTOM EXPANSION MODE

The screen is horizontally divided into two and the single (dual) frequency display and the bottom expansion display are presented on the same screen.

The bottom expansion range can be selected 0 to 1, 2.5, 5, 10, 20, 50, 100, 250m, fm, br. (0 to 5, 10, 20, 50, 100, 250, 500ft.)

Press **(BOTTOM EXPANSION) ↓** once displays the bottom expansion mode. Each press of **BOTTOM EXPANSION KEY** changes the bottom expansion range.

**CF** p.21 "BOTTOM EXPANSION"

## 9. SHALLOW ALARM

Beeps sound when the sea bottom becomes shallower than the set depth.

**SHALLOW ALARM KEY** moves the shallow alarm marker up/down. At the top end, the shallow alarm marker disappears from the screen.

Place the shallow alarm marker at the desired depth position, and press **ALARM ON** to set the alarm.

Press **ALARM OFF** to cancel the alarm.

## 10. DEEP ALARM

Beeps sound when the sea bottom becomes deeper than the set depth.

**DEEP ALARM KEY** moves the deep alarm marker up/down. At the bottom end, the deep alarm marker disappears from the screen.

Place the deep alarm marker at the desired depth position, and press **ALARM ON** to set the alarm.

Press **ALARM OFF** to cancel the alarm.

## **KEY OPERATION**

---

### **FISH ALARM**

The fish alarm goes off when the fish schools or any other objects appear between the two set points (the shallow alarm marker and the deep alarm marker.)

Place the shallow alarm marker and the deep alarm marker at the desired depth position, and press ALARM **ON** to set the alarm.

Press ALARM **OFF** to cancel the alarm.

### **11. ALARM ON/OFF**

Press ALARM **ON** to set (activate) the alarm function.

Press ALARM **OFF** to deactivate the alarm function.

When this function is activated, "AL-LOW or AL-HIGH" will be displayed in the left of the top screen.

### **12. THRESHOLD**

The equipment will pick up and display unwanted echoes from small objects in the water. With the threshold function it is possible to eliminate these unwanted echoes from the screen.

Each time **THRESHOLD KEY** is pressed the weakest echo color will be erased.

### **13. PICTURE SPEED**

Picture speed rate refers to the speed the picture travels from right to left on the screen. 1/1 refers to 1 vertical line of picture per 1 sound transmission, and 1/2 refers to 1 vertical line of picture per 2 sound transmissions. There is no relation to ship speed.

Each press of **PICTURE SPEED KEY** changes the speed of the picture.

The selected picture speed rate "PF-1/1, PF-1/2, PF-1/4, PF-1/8, or PF-STOP" is displayed at the center top of the screen.

## 14. MENU

Pressing **MENU** opens the main menu.  
Pressing it again closes the main menu.

**CF** p.15 “USER SETTING UP”

## 15. GAIN

It is another way of saying “sensitivity”.

Pressing **GAIN** displays the gain level scale.

In dual frequency mode, press **GAIN** once displays the low frequency gain level scale. Press **GAIN** twice displays the high frequency gain level scale.

**CF** p.14 “GAIN CONTROL”

## 16. INTERFERENCE REDUCTION

Interference generated by nearby fishing vessels or other equipment on your boat may be suppressed with this function.

Each press of **INTERFERENCE REDUCTION KEY** changes the level of reduction.

The selected level of reduction “IR-OFF, IR-LOW, IR-MID, or IR-HIGH” is displayed in the left of the top screen.

*\*\*Some types of noise interference may not be reduced.*

*\*\*Do not select excessive level than the one to be needed since the weak echoes may be erased.*

## 17. ENTER

Pressing **ENTER KEY** confirms the entry.

## DIAL OPERATION

### 18. GAIN CONTROL

Adjusts receiver sensitivity.

Turning **GAIN DIAL** clockwise increases the gain level, keep turning the dial until the sea bottom is shown in red.

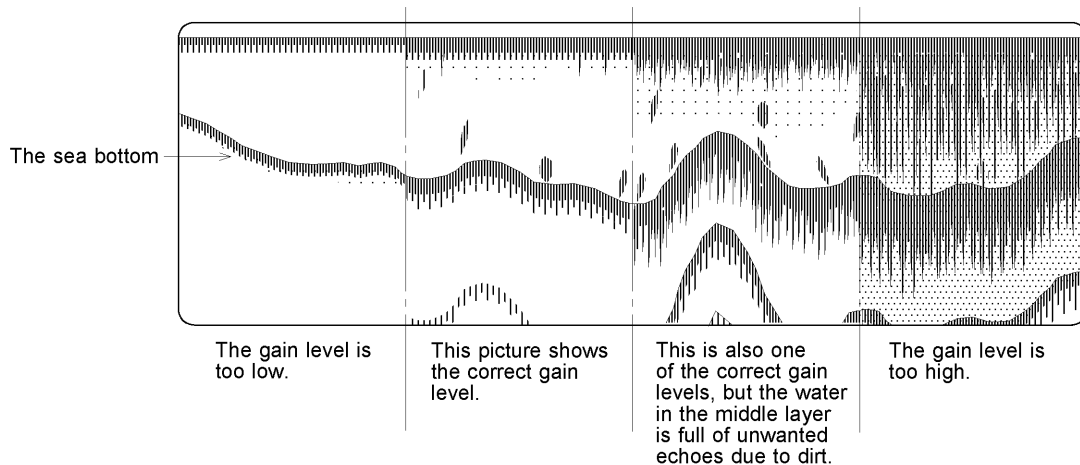

The strongest echoes are displayed in red and as the received echoes get weaker they are indicated as follows; red → orange → yellow → green → light green → blue → light blue.

When the target is the sea bottom, the gain level setting can be low because the echo from the sea bottom is very strong. However, when the target is fish, the level of gain must be increased to pick up the weaker echo.

Increasing the gain too much will display unwanted echoes from bubbles and plankton etc.

If the sea bottom echo is weak due to seaweed, mud etc. adjust the gain level to pick up the weaker echo.

When passing over the transducer face, bubbles reflect the sound wave appear as echoes on the screen. In this case, no echoes (fish school) may be displayed even though at a maximum gain level.

**CF** p.16 "GAIN UP"

### 19. BRIGHTNESS CONTROL

Adjusts screen brilliance.

Turning **BRIGHTNESS DIAL** clockwise direction increases screen brightness.

The screen brilliance level scale is displayed by pressing **ENTER KEY**.

## USER SETTING UP

Set each function before using the echo sounder ES-675 to suit individual needs.

Use the following keys to customizes each function items.

- MENU** : opens the main menu
- RANGE KEY** : highlights the item you wish to change
- PHASED RANGE KEY** : selects the desired function setting
- ENTER KEY** : completes the setup

### 1. MAIN MENU

Press **MENU** opens the main menu shown below.

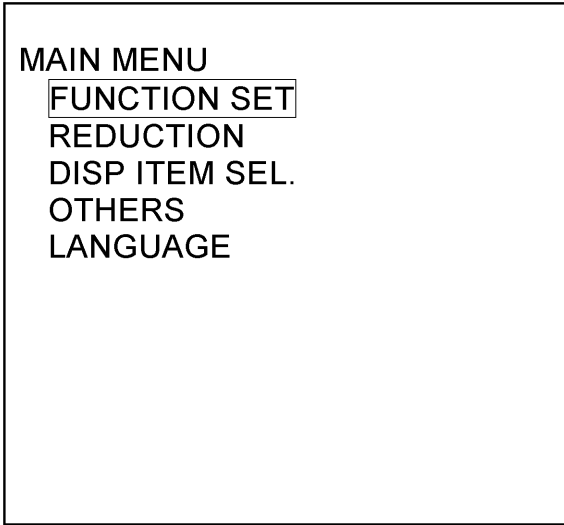

MAIN MENU  
FUNCTION SET  
REDUCTION  
DISP ITEM SEL.  
OTHERS  
LANGUAGE

## FUNCTION SETTING

---

### 2. FUNCTION SET

Press **MENU** + Use **RANGE KEYS** to highlight "FUNCTION SET" + Press **PHASED RANGE KEY** displays the function set menu shown below.

FUNCTION SET	
<b>RETURN MAIN MENU</b>	
L GAIN UP	OFF
L TVG	STC
L FAR GAIN	0
H GAIN UP	OFF
H TVG	STC
H FAR GAIN	0
D RANGE	+3dB

#### 2.1 GAIN UP

This function makes it possible to display a clearer picture of the full range and control sensitivity at various depths.

**SETTING** OFF, +10, +20, +30, +40, +50, +60

- **Display the function set menu + highlight "L GAIN UP" / "H GAIN UP" + use **PHASED RANGE KEYS** to select the desired gain adjust level + Press **ENTER KEY** to complete the setup.**

When the menu gain adjust setting is changed from OFF to +10dB, the gain level scale increases 10 points on the scale.

When the menu gain adjust setting is OFF and the gain level scale is on 10, it has the same result as when the menu gain adjust setting is 10dB and the gain level scale is on 0.

## 2.2 TVG

This function is a control that allows the unit to make corrections for most of the losses and absorption that occurs as sound energy passes through seawater. The TVG automatically compensates for the loss in signal strength.

**SETTING** STC, 1, 2, 3, 4

- Display the function set menu + highlight “L TVG” / “H TVG” + use **PHASED RANGE KEYS** to select the desired TVG adjust level + Press **ENTER KEY** to complete the setup.

This TVG setting influences the far gain and the gain control.

## 2.3 FAR GAIN

The power of the sound wave is absorbed at a certain rate when travel through the water. The higher the frequency is the higher the rate of absorption. For example after travelling 1 kilometer the power of a 50kHz sound wave will decrease to 1/8 of its original strength.

The power of a 200kHz sound wave will decrease to 1/300 of its original strength. Use this “FAR GAIN” function to counteract the absorption effect by increasing received echo signal of deep echoes.

**SETTING** 0 to 100

- Display the function set menu + highlight “L FAR GAIN” / “H FAR GAIN” + use **PHASED RANGE KEYS** to adjust the far gain + Press **ENTER KEY** to complete the setup.

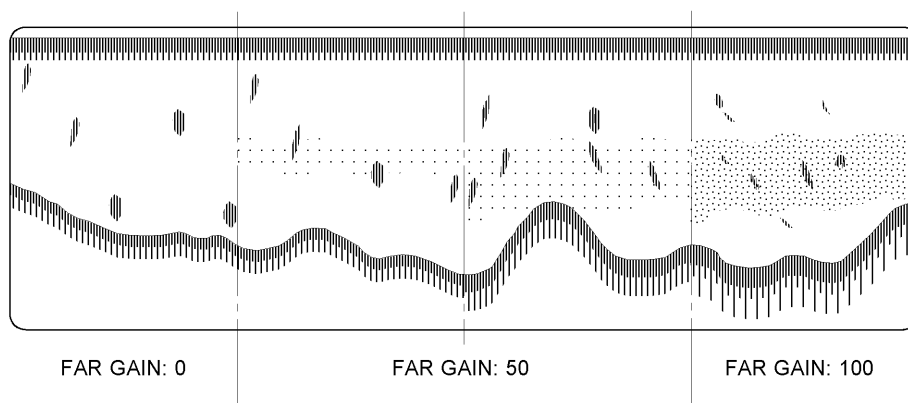

Turning the far gain level up does not increase the gain level close to the transducer but increases the gain level as the depth increases.

## FUNCTION SETTING

### 2.4 DYNAMIC RANGE

By shifting the dynamic range, the display to reflect the received echo more precisely or the display to discriminate their density is selected.

**SETTING** -3dB, -4dB, -5dB,  $\pm 6$ dB, +5dB, +4dB, +3dB, SP

- Display the function set menu + highlight "D RANGE" + use **PHASED RANGE KEYS** to select the desired dynamic range level + Press **ENTER KEY** to complete the setup.

Experimenting with this function will give you the best setting for various fishing operations.

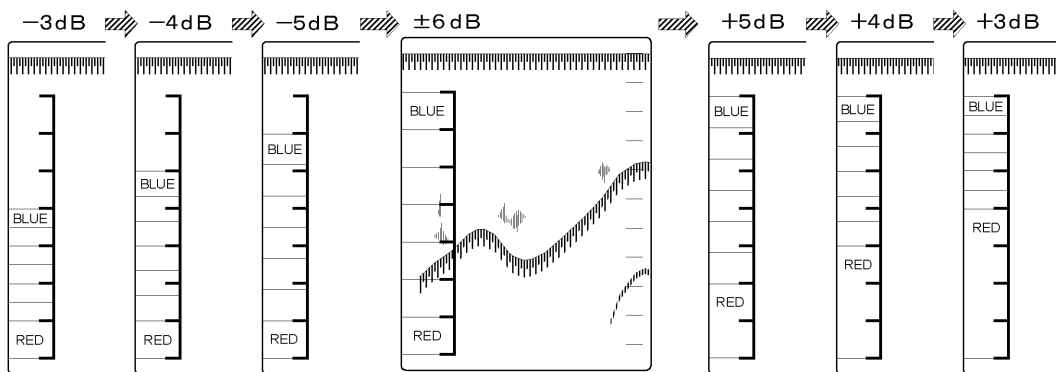

This picture shows the comparative signal threshold levels to the standard  $\pm 6$ dB for the dynamic ranges.

\*\*Do not select "SP".

### 3. REDUCTION

Press **MENU** + Use **RANGE KEYS** to highlight "REDUCTION" + Press **PHASED RANGE KEY** displays the reduction menu shown below.

REDUCTION	
<b>RETURN MAIN MENU</b>	
L CLUTTER	MID1
H CLUTTER	MID1
L STC	LOW
H STC	LOW
WHITE LINE	OFF

#### 3.1 CLUTTER

By using this function the unwanted weak echo can be get rid of.

**SETTING** OFF, LOW, MID1, MID2, HIGH

- Display the reduction menu + highlight "L CLUTTER" / "H CLUTTER" + use **PHASED RANGE KEY** to select the desired clutter level + Press **ENTER KEY** to complete the setup.

The higher the clutter level, the weak echo disappears.

If the clutter level is too high, the strong echo will disappear.

## FUNCTION SETTING

---

### 3.2 STC

Sensitivity Time Control is used for reduce shallow water clutter. Shallow seabed echo is strong and deep seabed echo is weak. So, the STC controls the sensitivity to normalize seabed echo for precision seabed tracking.

**SETTING** OFF, LOW, MID1, MID2, HIGH

- Display the reduction menu + highlight “L STC” / “H STC” + use **PHASED RANGE KEYS** to select the desired STC level + Press **ENTER KEY** to complete the setup.

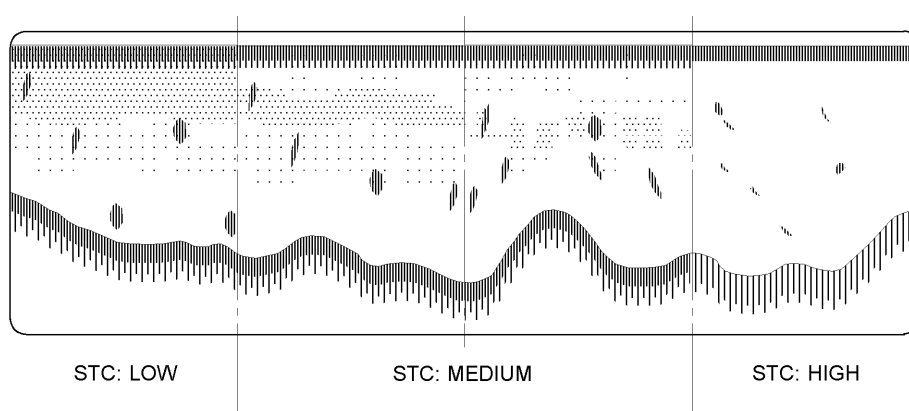

Selecting “HIGH” may suppress fish school and bottom signal.

### 3.3 WHITE LINE

The function of the white line is to help in discriminating the bottom and fish lying on or very close to the bottom.

**SETTING** OFF, ON

- Display the reduction menu + highlight “WHITE LINE” + use **PHASED RANGE KEYS** to select “OFF” or “ON” + Press **ENTER KEY** to complete the setup.

## 4. DISPLAY ITEM SELECTION

Press **MENU** + Use **RANGE KEYS** to highlight "DISP ITEM SEL." + Press **PHASED RANGE KEY** displays the display item selection menu shown below.

DISP ITEM SEL.	
<b>RETURN MAIN MENU</b>	
BTM EXPN	CONST1
DEPTH DISP	LARGE
SCALE	RIGHT
SCALE FONT	LARGE
TEMP DISP	OFF
TEMP GRAPH	OFF
LAT.LONG.	OFF
SPEED DISP	OFF
COURSE	OFF
PIC. SPEED	X1

### 4.1 BOTTOM EXPANSION

When you activate the bottom expansion mode, the areas of the bottom contour can be selected by the following shifts and displayed across the screen for close observation of the echoes of interest on or near the bottom.

**SETTING** CONST1, CONST2, CONST3, AUTO

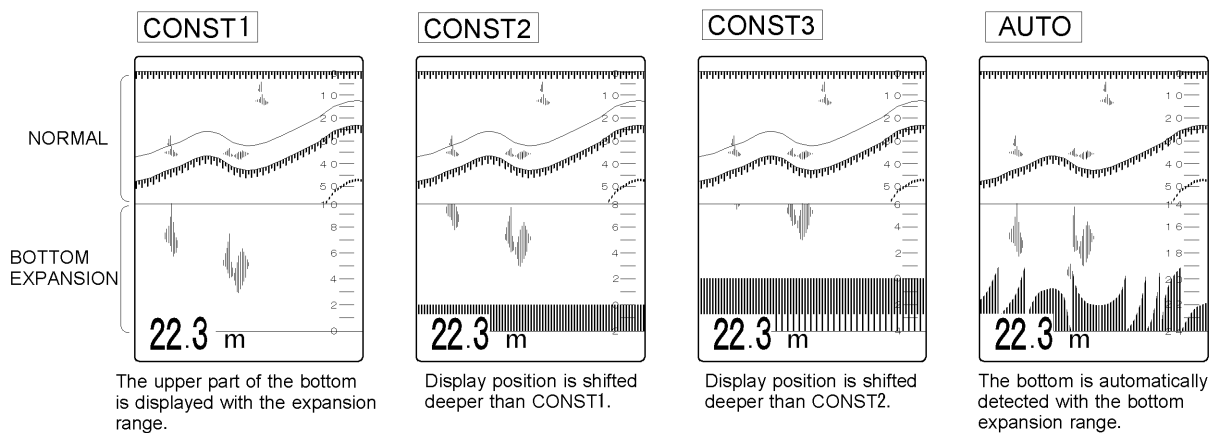

- Display the display item selection menu + highlight "BTM EXPN" + use **PHASED RANGE KEYS** to select the desired shift + Press **ENTER KEY** to complete the setup.

## FUNCTION SETTING

---

### 4.2 DEPTH DISPLAY SIZE

Selects the size of the digital display for depth.

**SETTING** OFF, SMALL, MEDIUM, LARGE, ULARGE

- Display the display item selection menu + highlight “DEPTH DISP” + use **PHASED RANGE KEYS** to select the desired size + Press **ENTER KEY** to complete the setup.

### 4.3 SCALE

Selects the depth scale position on the screen.

**SETTING** OFF, RIGHT, CENTER

- Display the display item selection menu + highlight “SCALE” + use **PHASED RANGE KEYS** to select the desired position + Press **ENTER KEY** to complete the setup.

### 4.4 SCALE FONT

Selects the size of the digital display for depth and scale size.

**SETTING** SMALL, MEDIUM, LARGE

- Display the display item selection menu + highlight “SCALE FONT” + use **PHASED RANGE KEYS** to select the desired size + Press **ENTER KEY** to complete the setup.

### 4.5 TEMPERATURE DISPLAY

Selects the size of the digital display for water temperature.

**SETTING** OFF, SMALL, LARGE

- Display the display item selection menu + highlight “TEMP DISP” + use **PHASED RANGE KEYS** to select the desired size + Press **ENTER KEY** to complete the setup.

*\*\*Optional equipment is required to show the water temperature display.*

*\*\*Select “OFF” when the optional equipment is not connected.*

## 4.6 TEMPERATURE GRAPH

Shows the temperature graph.

**SETTING** OFF, ON

- Display the display item selection menu + highlight “TEMP GRAPH” + use **PHASED RANGE KEYS** to select “OFF” or “ON” + Press **ENTER KEY** to complete the setup.

*\*\*Optional equipment is required to show the water temperature graph.*

*\*\*Select “OFF” when the optional equipment is not connected.*

## 4.7 LATITUDE / LONGITUDE

Selects the size of the digital display for latitude and longitude.

**SETTING** OFF, SMALL, LARGE

- Display the display item selection menu + highlight “LAT.LONG.” + use **PHASED RANGE KEYS** to select the desired size + Press **ENTER KEY** to complete the setup.

*\*\*Optional equipment is required to show the latitude / longitude display.*

*\*\*Select “OFF” when the optional equipment is not connected.*

## 4.8 SPEED DISPLAY

Selects the size of the digital display for ship’s speed.

**SETTING** OFF, SMALL, LARGE

- Display the display item selection menu + highlight “SPEED DISP” + use **PHASED RANGE KEYS** to select the desired size + Press **ENTER KEY** to complete the setup.

*\*\*Optional equipment is required to show the ship’s speed.*

*\*\*Select “OFF” when the optional equipment is not connected.*

### 4.9 COURSE

Selects the size of the digital display for ship's course.

**SETTING** OFF, SMALL, LARGE

- Display the display item selection menu + highlight "COURSE" + use **PHASED RANGE KEYS** to select the desired size + Press **ENTER KEY** to complete the setup.

*\*\*Optional equipment is required to show the ship's course.*

*\*\*Select "OFF" when the optional equipment is not connected.*

### 4.10 PICTURE ADVANCE SPEED

The picture advance speed determines how quickly the vertical scan lines run across the screen.

**SETTING** X1, X2, X3, X4

- Display the display item selection menu + highlight "PIC. SPEED" + use **PHASED RANGE KEYS** to select the desired speed + Press **ENTER KEY** to complete the setup.

When choosing a faster speed, keep in mind that a fast advance speed will show a rougher picture.

**CF** p.12 "PICTURE SPEED"

## 5. OTHERS

Press **MENU** + Use **RANGE KEYS** to highlight "OTHERS" + Press **PHASED RANGE KEY** displays the others menu shown below.

OTHERS	
<b>RETURN MAIN MENU</b>	
DEPTH UNIT	m
TEMP UNIT	°C
TEMP ADJ	0.0
SPEED UNIT	kt
COLOR SET	A-1
TRANS RATE	MEDIUM
PANEL BRIGHT	20
TEMP SENSOR	OP-102
ALARM	LOW
MJR FREQ	LOW

### 5.1 DEPTH UNIT

Selects the depth unit.

**SETTING** ft, m, br, fm

- Display the others menu + highlight "DEPTH UNIT" + use **PHASED RANGE KEY** to select the desired unit + Press **ENTER KEY** to complete the setup.

### 5.2 TEMPERATURE UNIT

Selects the water temperature unit.

**SETTING** °C, °F

- Display the others menu + highlight "TEMP UNIT" + use **PHASED RANGE KEY** to select the desired unit + Press **ENTER KEY** to complete the setup.

## FUNCTION SETTING

---

### 5.3 TEMPERATURE ADJUSTMENT

Offsets water temperature indication to improve accuracy when a water temperature sensor is connected.

**SETTING** -9.9 to +9.9

- Display the others menu + highlight “TEMP ADJ” + use **PHASED RANGE KEY** to adjust the displayed water temperature value + Press **ENTER KEY** to complete the setup.

### 5.4 SPEED UNIT

Selects the speed unit.

**SETTING** kt, km/h

- Display the others menu + highlight “SPEED UNIT” + use **PHASED RANGE KEY** to select the desired unit + Press **ENTER KEY** to complete the setup.

### 5.5 COLOR SET

Selects the background and the scale color combination out of 6 basic color sets.

**SETTING** A-1, A-2, B-1, B-2, C-1, C-2

- Display the others menu + highlight “COLOR SET” + use **PHASED RANGE KEY** to select the desired color set + Press **ENTER KEY** to complete the setup.

The setups of A-1, A-2, B-1, and B-2 are fix and therefore not adjustable. The setups of C-1 and C-2 can be customized freely.

## COLOR PALETTE SET

The setups of C-1 and C-2 can be customized freely to suit individual needs.

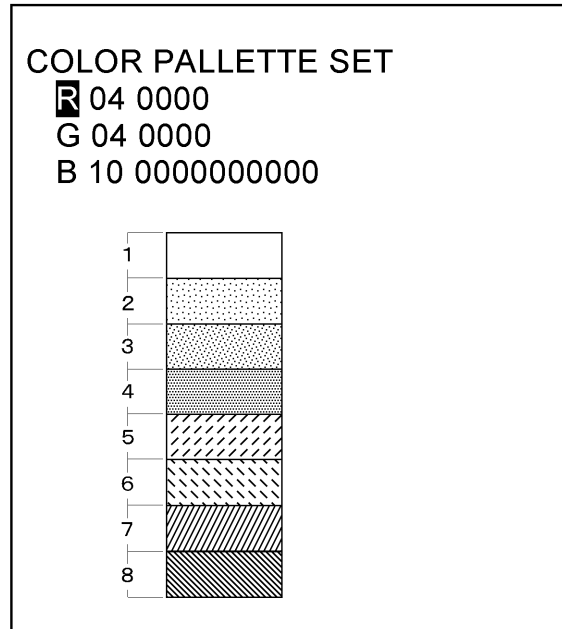

1. Display the others menu + highlight "COLOR SET" + use **PHASED RANGE KEY** to select "C-1" or "C-2" + Press **THRESHOLD KEY** displays the color palette set menu shown above.
2. Use **RANGE KEY** to select the color to be changed from the color scale. Each numeral color intensity (R, G, B) will be displayed on the menu.
3. Use **THRESHOLD KEY** to highlight "R", "G", or "B" + Change the color intensity with the **PHASED RANGE KEY** + Press **ENTER KEY** to complete the setup.

## RETURN TO FACTORY SETTING COLOR (DEFAULT COLOR)

Turn on the power while pressing **THRESHOLD KEY**.

After this operation all color will then return to the factory setting color (default color).

*\*\*Releasing the keys before the beeps sound may not complete the setting.*

## FUNCTION SETTING

---

### 5.6 TRANSMIT RATE

Selects the transmit rate of sound waves from the transducer.

**SETTING** LOW, MEDIUM, HIGH

- Display the others menu + highlight “TRANS RATE” + use **PHASED RANGE KEY** to select the desired transmit rate + Press **ENTER KEY** to complete the setup.

### 5.7 PANEL BRIGHTNESS

Adjusts the control panel brightness.

**SETTING** 0 to 20

- Display the others menu + highlight “PANEL BRIGHT” + use **PHASED RANGE KEY** to adjust the control panel brightness + Press **ENTER KEY** to complete the setup.

### 5.8 TEMPERATURE SENSOR

Selects one of the interfacing connections for temperature sensor.

**SETTING** OP-102, OP-41-1, NMEA-0183

- Display the others menu + highlight “TEMP SENSOR” + use **PHASED RANGE KEY** to select the desired connection type + Press **ENTER KEY** to complete the setup.

### 5.9 ALARM

Selects the frequency to set the alarm while performing dual frequency.

**SETTING** LOW, HIGH

- Display the others menu + highlight “ALARM” + use **PHASED RANGE KEY** to select “LOW” or “HIGH” + Press **ENTER KEY** to complete the setup.

The selected frequency “AL-LOW” or “AL-HIGH” is displayed in the left of the top screen while alarm function is activating.

## 5.10 MAJOR FREQUENCY

Selects main frequency to measure the depth while performing dual frequency.

**SETTING** LOW, HIGH

- Display the others menu + highlight “MJR FREQ” + use **PHASED RANGE KEY** to select “LOW” or “HIGH” + Press **ENTER KEY** to complete the setup.

In case the selected frequency is disabled the other frequency may be activated automatically.

## 6. LANGUAGE

Press **MENU** + Use **RANGE KEYS** to highlight “LANGUAGE” + Press **PHASED RANGE KEY** displays the language menu shown above.

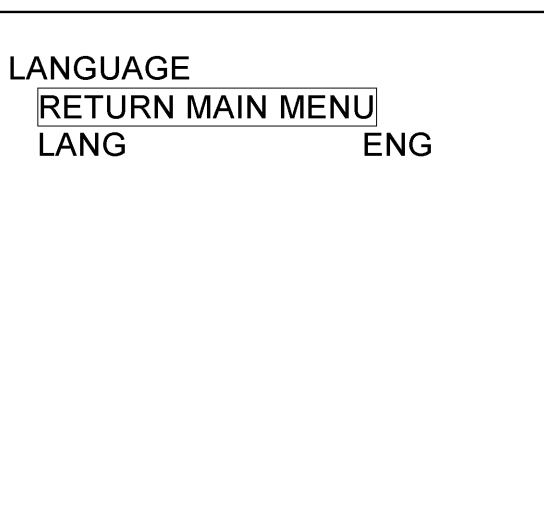

### 6.1 LANG

Selects the language for menu and screen.

**SETTING** ENG, JPN, SPANISH, VIETNAMESE, THAI, CHI, KOR

- Display the language menu + highlight “LANG” + use **PHASED RANGE KEY** to select the desired language + Press **ENTER KEY** to complete the setup.

## **FUNCTION SETTING**

---

### **COLOR PRESENTATION**

Change the color presentation from 8 to 16 colors (from 16 to 8 colors).

Turn on the power while pressing **MENU**.

*\*\*Releasing the keys before the beeps sound may not change the color presentation.*

### **SIMULATION MODE**

A simulation mode may be run with the below keys.

Turn on the power while pressing **(SHALLOW ALARM) ↑** and **ALARM ON**.

*\*\*Releasing the keys before the beeps sound may not start the simulation mode.*

### **SELECTING THE RANGE**

The range can be changed at the simulation mode.

Press both **(SHALLOW ALARM) ↑** and **(DEEP ALARM) ↑** at the same time to shallower the range.

Press both **(SHALLOW ALARM) ↓** and **(DEEP ALARM) ↓** at the same time to deeper the range.

**MENU TREE**

MAIN MENU

FUNCTION SET	<ul style="list-style-type: none"> <li>— L GAIN UP</li> <li>— L TVG</li> <li>— L FAR GAIN</li> <li>— H GAIN UP</li> <li>— H TVG</li> <li>— H FAR GAIN</li> <li>— D RANGE</li> </ul>	<ul style="list-style-type: none"> <li>OFF, +10, +20, +30, +40, +50, +60</li> <li>STC, 1, 2, 3, 4</li> <li>0 (~100)</li> <li>OFF, +10, +20, +30, +40, +50, +60</li> <li>STC, 1, 2, 3, 4</li> <li>0 (~100)</li> <li>-3dB, -4dB, -5dB, ±6dB, +5dB, +4dB, <b>+3dB</b>, SP</li> </ul>
REDUCTION	<ul style="list-style-type: none"> <li>— L CLUTTER</li> <li>— H CLUTTER</li> <li>— L STC</li> <li>— H STC</li> <li>— WHITE LINE</li> </ul>	<ul style="list-style-type: none"> <li>OFF, LOW, <b>MID1</b>, MID2, HIGH</li> <li>OFF, LOW, <b>MID1</b>, MID2, HIGH</li> <li>OFF, <b>LOW</b>, MID1, MID2, HIGH</li> <li>OFF, <b>LOW</b>, MID1, MID2, HIGH</li> <li>OFF, ON</li> </ul>
DISP ITEM SEL.	<ul style="list-style-type: none"> <li>— BTM EXPN</li> <li>— DEPTH DISP</li> <li>— SCALE</li> <li>— SCALE FONT</li> <li>— TEMP DISP</li> <li>— TEMP GRAPH</li> <li>— LAT. LONG.</li> <li>— SPEED DISP</li> <li>— COURSE</li> <li>— PIC. SPEED</li> </ul>	<ul style="list-style-type: none"> <li>CONST1, CONST2, <b>CONST2</b>, AUTO</li> <li>OFF, SMALL, MEDIUM, <b>LARGE</b>, ULARGE</li> <li>OFF, <b>RIGHT</b>, CENTER</li> <li>SMALL, MEDIUM, <b>LARGE</b></li> <li>OFF, SMALL, LARGE</li> <li>OFF, ON</li> <li>OFF, SMALL, LARGE</li> <li>OFF, SMALL, LARGE</li> <li>OFF, SMALL, LARGE</li> <li>X1, X2, X3, X4</li> </ul>
OTHERS	<ul style="list-style-type: none"> <li>— DEPTH UNIT</li> <li>— TEMP UNIT</li> <li>— TEMP ADJ</li> <li>— SPEED UNIT</li> <li>— COLOR SET</li> <li>— TRANS RATE</li> <li>— PANEL BRIGHT</li> <li>— TEMP SENSOR</li> <li>— ALARM</li> <li>— MJR FREQ</li> </ul>	<ul style="list-style-type: none"> <li>ft, <b>m</b>, br, fm</li> <li>°C, °F</li> <li>(-9.9~) <b>+0.0</b> (~+9.9)</li> <li>kt, km/h</li> <li>A-1, A-2, B-1, B-2, C-1, C-2</li> <li>LOW, <b>MEDIUM</b>, HIGH</li> <li>0 (~20)</li> <li>OP-102, OP-41-1, NMEA-0183</li> <li>LOW, HIGH</li> <li>LOW, HIGH</li> </ul>
LANGUAGE	ENG, JPN, SPANISH, VIETNAMESE, THAI, CHI, KOR	

*\*\*Default setting shown in bold.*

## **INITIAL SETTINGS**

---

### **RETURN TO FACTORY SETTINGS (DEFAULT SETTINGS)**

Turn on the power while pressing **ENTER KEY**.

After this operation all functions will then return to the factory settings (default settings).

### **USER SETTINGS**

Being separated from the factory setting function, settings may be entered by the user and memorized. This function is called "User settings". By entering "User settings" the ES-675 to suit individual needs can be done. This not only simplifies operation of the ES-675, but also adds considerably to its reliability.

All user-implemented data in the ES-675 can be erased by making a reset of the unit and thus return to "User settings". Please ensure the "User settings" are memorized on the first operation.

#### **1. MEMORIZE USER SETTINGS**

First ensure the functions are at the desired settings.

Then turn off the power once, and turn the power back on while pressing **AT-R**. After this operation all functions will be memorized under the user settings.

#### **2. RETURN TO USER SETTINGS**

In case, for some reason, ES-675 becomes inoperable, the unit can be reset by turning the power off and then turn the power back on while pressing **AT-S**. After this operation all functions will return to the user settings.

#### **3. CHANGING USER SETTINGS**

To change the functions in user settings first activate "RETURN TO FACTORY SETTINGS" and then "MEMORIZE USER SETTINGS" again as described in the previous item 1.

*\*\*Releasing the keys before the beeps sound may not complete the above settings.*

## ES-675 DIMENSIONS

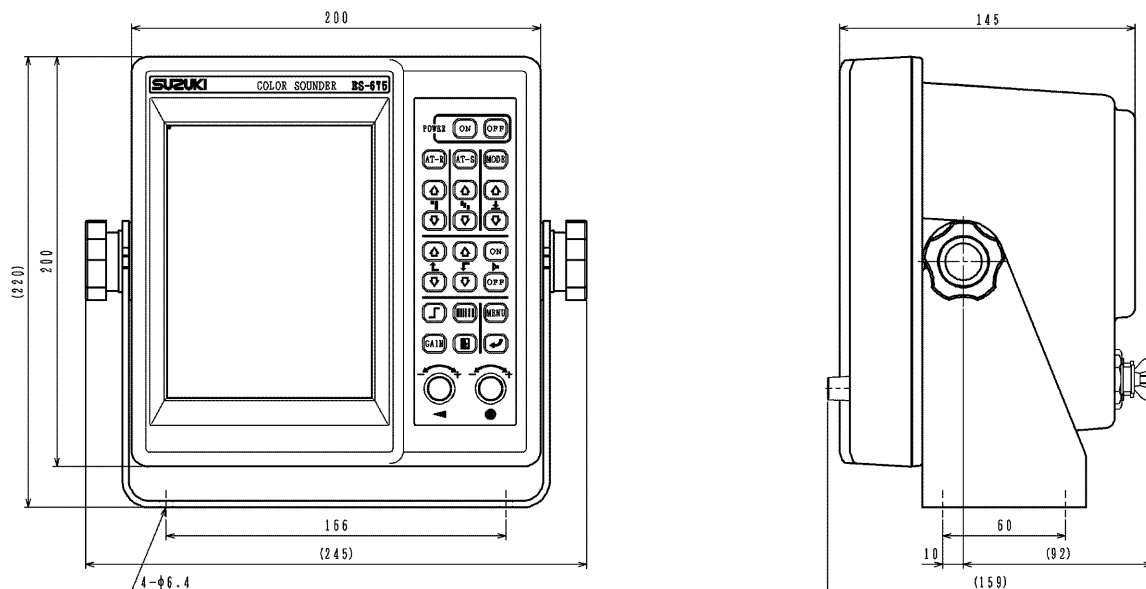

## SUPPLIED COMPONENTS

Code	Item	Qty.	Parts Number
	Main unit	1	
	Bracket	1	36250B
NT010	Power supply cable	1	36228D
	Truss tapping screw	4	M6x20 (SUS)
	3 pin connector	1	6282-3SG-321
	8 pin connector	1	3282-8SG-321
	Fuse	3	3A
	Knob Bolt	2	KG-B2/M6x15
	NT121	Cover	1
	Operation Manual	1	
	Transducer	1	NMM40-50/200_8L

*\*\*The code and the management number are written on the each package.*

## INSTALLATION

---

### MOUNTING METHOD OF MAIN UNIT

1. Fasten the bracket to the place you selected with 4 tapping screws.
2. Screw the knob bolts to the hole on both sides of the main unit.
3. Insert the main unit into the bracket.
4. Adjust the knob bolts to select a comfortable viewing angle of the main unit.

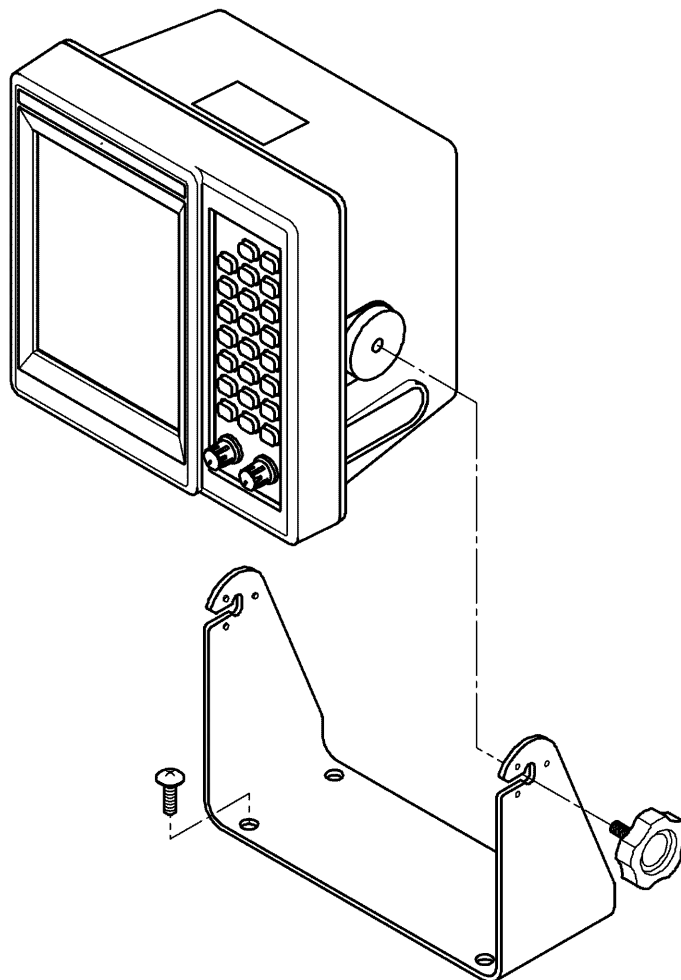

**WARNING**

Do not install the unit on unstable or uneven surface.

Do not use the unit while tentatively mounted.  
Otherwise it may result in the unit falling or toppling over,  
resulting in injury.



**CAUTION**

Be free as much as possible from shocks and engine vibrations.

Mount the unit in a location away from salt spray, heat sources, and direct sunlight.

## CONNECTIONS

Prior to the connections of the main unit, read the following warning carefully to ensure its correct operation.



Operating voltage: 10.5 to 30 volts DC  
Use the correct voltage otherwise it will result in fire or electrical shock.

Use the specified power supply cables.  
If not, it could result in serious trouble or fire.

Always turn off the power before connecting or disconnecting the unit.

Pulling the cables may damage the cables themselves and result in fire or electrical shock.

Bring wiring to the following attention to avoid getting hurt or causing fire or damage.

Run the cables not to touch the rotary obstacles or disturb the operation.

Do not use the cables bent, twisted or stretched by force.  
Do not put heavy objects on the cables.



Turn off the power by POWER **OFF** on the control panel.

Do not turn off the power by the switch-board or the breaker.

Confirm the power of the main unit is turned off before turning off the switch-board or the breaker.

Use the proper fuse.

## INSTALLATION

### ELECTRICAL CONNECTIONS - TERMINALS

The below drawings show the terminals on the rear of the main unit.

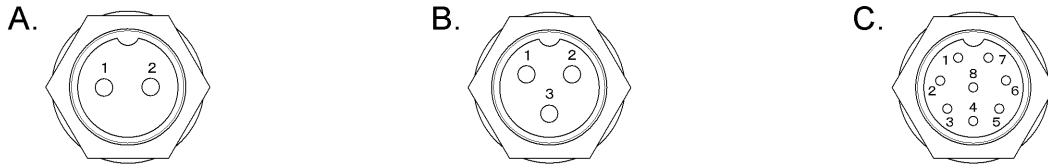

#### A. POWER SUPPLY TERMINAL

Pin	Connection
1	DC -
2	DC +

#### B. 3 PIN TRANSDUCER TERMINAL

Pin	Connection
1	TRANSDUCER
2	TRANSDUCER
3	SHIELD

#### C. 8 PIN CONTROL TERMINAL

Pin	Connection
1	NMEA-IN +
2	NMEA-IN -
3	NMEA-OUT +
4	NMEA-OUT -
5	TEMPERATURE SENSOR
6	GND
7	N.C.
8	SHIELD

**\*\*Do not connect anything to "N.C.".**

### **CLEANING MAIN UNIT**

Make sure to turn off the power before cleaning.

Do not use any chemical cleaners to clean the ES-675.

Wipe off dust or salt crystals from the filter lightly with a soft wet cloth.

Breathe out on the surface, and wipe off dust lightly with an absorbent cotton or clean soft cloth.

Using a dry or firm cloth may scratch the surface of LCD display. LCD display with many scratches shows the poor visibility of the screen.

If there is dust you cannot wipe away, contact your local dealer or SUZUKI head office.

### **DISPOSAL OF EQUIPMENT**

Dispose of this equipment in accordance with local regulations.

### **DISPOSAL OF LITHIUM BATTERY**

Before disposing of the lithium battery, place a piece of adhesive tape across the plus and minus terminals as non-combustible garbage.

Dispose of the lithium battery in accordance with local regulations.



This equipment contains the lithium battery of high-density energy.

Careless disposal of the lithium battery causes electric shorts, impact, heat, electrical shock, explosion, injury, fire and so on.

## SPECIFICATIONS

## SPECIFICATIONS

<b>Basic ranges</b>	0 ~ 5, 10, 15, 20, 30, 40, 50, 60, 70, 80, 90, 100, 150, 200, 300, 400, 500, 600, 700, 800, 900, 1000 m. fm. or br. 0 ~ 20, 30, 40, 50, 60, 70, 80, 90, 100, 200, 300, 400, 500, 600, 700, 800, 900, 1000, 1500, 2000, 2500, 3000 ft
<b>Range phasing</b>	The upper range limit may be set per 2/5 of the basic range up to 999m, br. fm. or 2999ft
<b>Partial expansion ranges</b>	0 ~ 1, 2.5, 5, 10, 20, 50, 100, 250 m. fm. or br. 0 ~ 5, 10, 20, 50, 100, 250, 500, 1000 ft
<b>Frequency</b>	Dual frequency 50 and 200kHz transmitted alternately
<b>Display modes</b>	1. Single low frequency 2. Single high frequency 3. Single low frequency + Bottom expansion 4. Single high frequency + Bottom expansion 5. Dual frequency 6. Dual frequency + Bottom expansion 7. Function set menu 8. Color palette set menu
<b>Digital displays</b>	1. Depth 2. Depth scale 3. Phased range 4. Temperature* 5. Temperature scale* 6. Lat / Lon* 7. Speed* 8. Course*
<b>Function display</b>	Auto range, Auto shift, Alarm, Picture speed, Interference reduction
<b>Other display data</b>	Time marker, Color scale, Alarm marker, Temperature graph*
<b>Other functions</b>	Prior frequency, STC, Gain control, TVG, D-range, Color selection, Threshold, Clutter, Temperature adjustment, White line, Shallow alarm, Deep alarm, Fish alarm, Brightness control, STC, Scare position, Transmit rate, Setting keep, Factory settings, User settings
<b>External input</b>	Water temperature sensor* (OP-102, OP-41-1), Water temperature data* (NMEA-0183 [MTW]), Navigational data* (NMEA-0183 [RMC, GGA, GLL, VTG and so on])
<b>External output</b>	NMEA-0183 (MTW, DBT)* (transmit the both sentences every second together.)
<b>Screen</b>	High-resolution 6.5 inch VGA color LCD display (640x480 pixels, 8 or 16 colors)
<b>Power requirement</b>	DC 10.5 ~ 30V, 16W

*\*Optional equipment is required.*

