

Technical specification

Display	
Resolution	800 x 480
Brightness	>1200 nits
Touch screen	Full touch screen (multi-touch)
Viewing angles	Left/right: 70°, top: 50°, bottom: 60°
Electrical	
Supply voltage	12/24 V DC (9.0 - 31.2 V DC min - max)
Power consumption	680 mA/ 330 mA at 12 V DC (backlight full/off) 380 mA/200 mA at 24 V DC (backlight full/off)
Recommended fuse rating (12 V / 24 V)	3 A
Environmental	
Temperature range	-15°C to +55°C (5°F to 131°F)
Storage temperature	-20°C to +60°C (4°F to 140°F)
Waterproof rating	IPX2
Category	Protected
Shock, vibration and humidity	According to IEC 60945
Interface/Connectivity	
Ethernet	1x (RJ45) 100Base-TXS, 8P8C connector, IPv4
Lightweight Ethernet protocol	IEE 802.3
Maximum data rate	450 sps addressed to device, 500 sps unintended
Buffer capacity	Dynamic serial buffer
NMEA 2000	1x (Micro-C, 1 LEN)
Data card reader	1x slot (microSD)
Comms	
IEC 61162-2 ports	2x
Digital input	1x
Analog input	1x (voltage, OR frequency, OR current)
Power output (+16 V DC, 70 mA)	1x
Datagram types	NkPgN and UdPbC
Physical	
Compass Safe Distance - Metric, imperial	0.9 m (2.95 ft)
Weight (display only)	1.32 kg (2.91 lbs)

For product manuals, technical specifications, certificates and declarations, refer to: www.navico-commercial.com

Bracket mounting

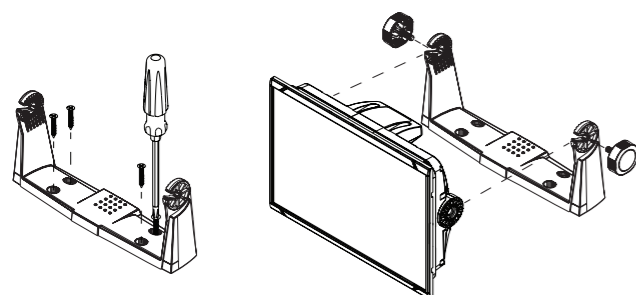

Dimensional drawings

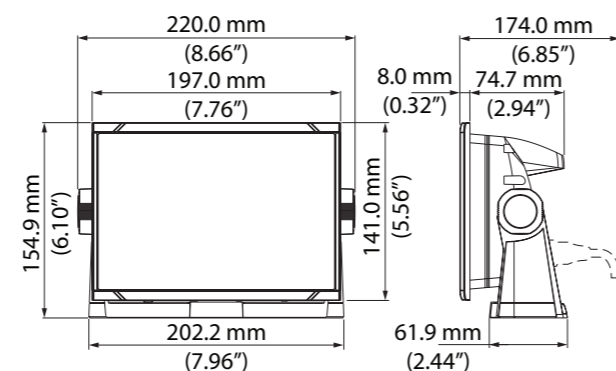

SIMRAD

I3007 Installation Guide

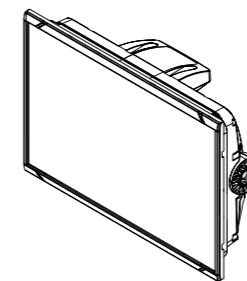

Parts

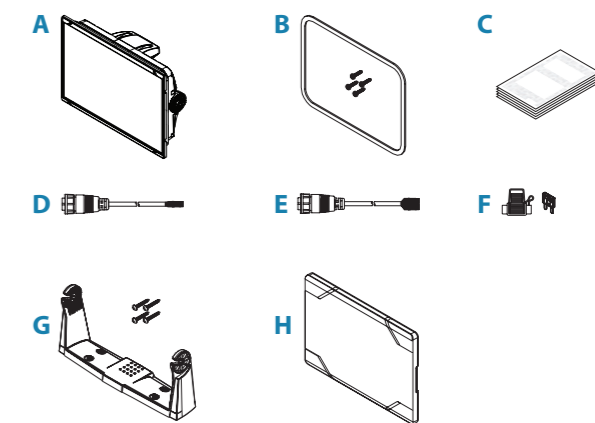

- A. I3007 unit
- B. Panel mounting kit
- C. Documentation
- D. Power cable
- E. Communication cable
- F. Fuse kit
- G. Bracket kit
- H. Suncover (sold separately)

System example

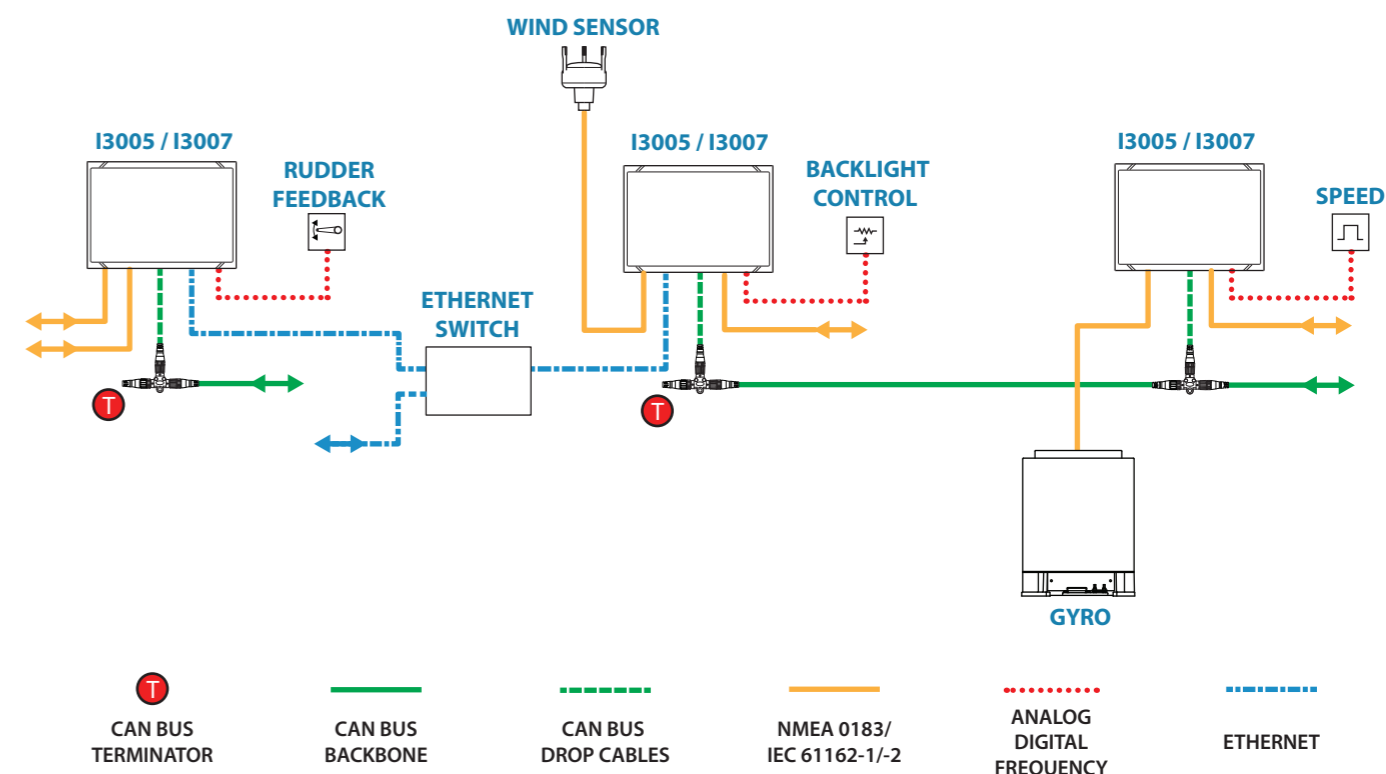

Connector overview

- A. NMEA 2000, Micro-C connector
- B. Ethernet, RJ45 connector
- C. Power and external alarm, 4-pin connector
- D. Ground, M4 threaded insert
- E. Comms (communication), 19-pin connector

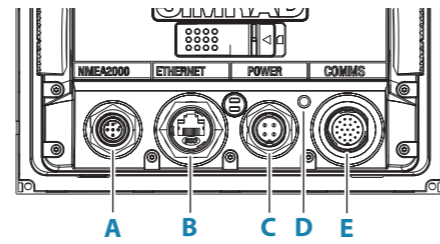

Grounding

- A. Ground, M4 threaded insert
- B. Grounding cable, min. 0.82 mm² (18 AWG)
- C. Star washer
- D. Screw (M4-.7 X 6 mm)

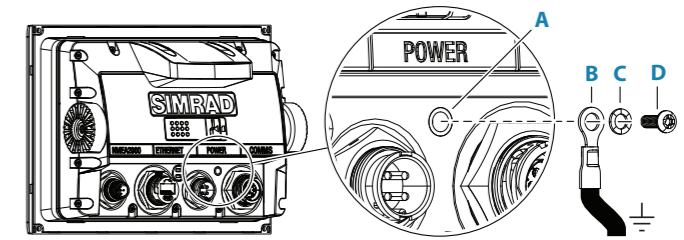

→ **Note:** It is recommended that the unit ground is connected to the vessel's bonded ground or a non-bonded RF ground.

Power and external alarm

- A. DC negative - black
- B. +12/24 V DC - red
- C. Fuse
- D. Power failure alarm output (contact return) - blue
- E. Power failure alarm output (N/C isolated contact) - yellow
- F. Alert management system

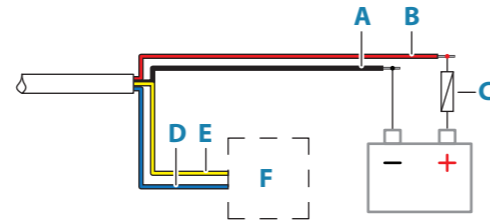

→ **Note:** Refer to the technical specification for electrical details.

Analog port

The analog port can be configured for current, voltage or frequency input. Refer to the User Manual for local port setup.

Function	Voltage (V DC)						Current (mA)		Frequency
	+3 - +21	-10 - +10	0 - +10	-5 - +5	0 - +5	0 - +16	4 - 20	0.1 - 1.1	
Rudder angle	x	x	x	x	x	x	x	x	x
Engine RPM	x	x	x	x	x	x	x	x	
Propeller shaft RPM	x	x	x	x	x	x	x	x	
Rate of turn		x	x	x	x	x			
Propeller pitch	x	x	x	x	x	x	x		
Thruster pitch	x	x	x	x	x	x	x	x	
Backlight control	See backlight control description								

Pin/wire	Color	Current	Voltage	Frequency	Backlight control
2	red			freq Hi / +16 V DC (max. 70 mA)	+16 V DC (max. 70 mA)
11	blue/white	Connected to pin / wire 13	positive		signal in
12	Blue/red	positive		freq Low / signal in	
13	grey/orange	negative	negative	return	return
14	drain (clear shrink tube)	not used	not used	not used	not used

Ethernet

The unit is equipped with a standard RJ-45 connector.

→ **Note:** Network switches can be used to extend the network. Routers and repeater hubs shall not be used.

Network traffic filtering by external managed switch supports IGMP version 2.

NMEA 2000

The unit is equipped with a standard Micro-C connector.

Communication cable

Refer to the Operator Manual for software setup. Wiring illustrations only include the required wires for the example.

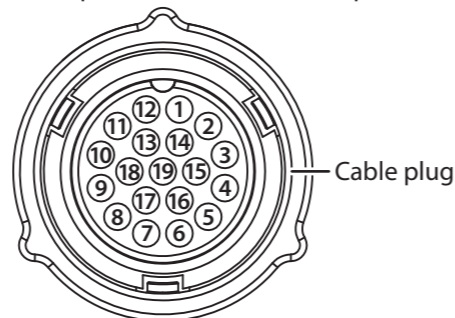
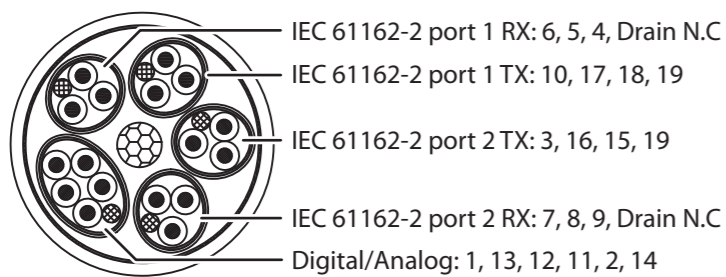

IEC 61162-2

Pin/Wire	Color	IEC 61162-2 port 1
10	black	TX common
17	white	talker (TX_A)
18	brown	talker (TX_B)
19	drain (gray shrink tube)	TX drain
7	black/white	RX common
8	yellow	listener (RX_A)
9	green	listener (RX_B)
N.C	drain (purple shrink tube)	RX drain

Pin/Wire	Color	IEC 61162-2 port 2
3	black/red	TX common
16	white/red	talker (TX_A)
15	brown/red	talker (TX_B)
19	drain (blue shrink tube)	TX drain
6	brown/red	RX common
5	yellow/red	listener (RX_A)
4	green/red	listener (RX_B)
N.C	drain (orange shrink tube)	RX drain

Backlight control / Rudder potentiometer

Potentiometer (10 k - 100 k Ohm, min 1 W)

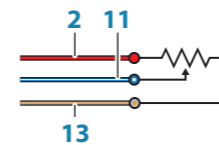

Voltage sensor signal input

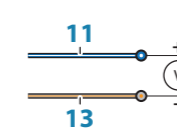

Current sensor signal input (mA)

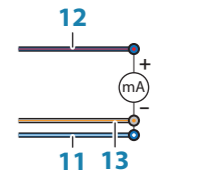

Frequency

Supports rudder feedback units with:

- 3400 Hz as mid-position reference
- 20 Hz / degree increasing when the rudder moves to port and vice versa

2 wire example

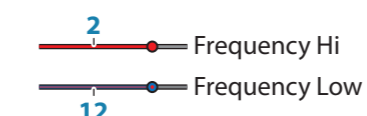

3 wire example

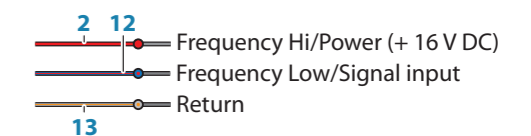

Digital port (speed)

Pin/wire	Color	Speed log
1	Pink	signal in
13	gray/orange	ground
14	drain (clear shrink tube)	not used

A speed log that outputs 200 pulses per nautical mile can be connected to the digital port.

- A. Speed log (200 pulses/NM)
- B. Ship's ground

