

Tron 40AIS

Float-free EPIRB

User manual



1 Manual operation and activation

Use only in emergency!

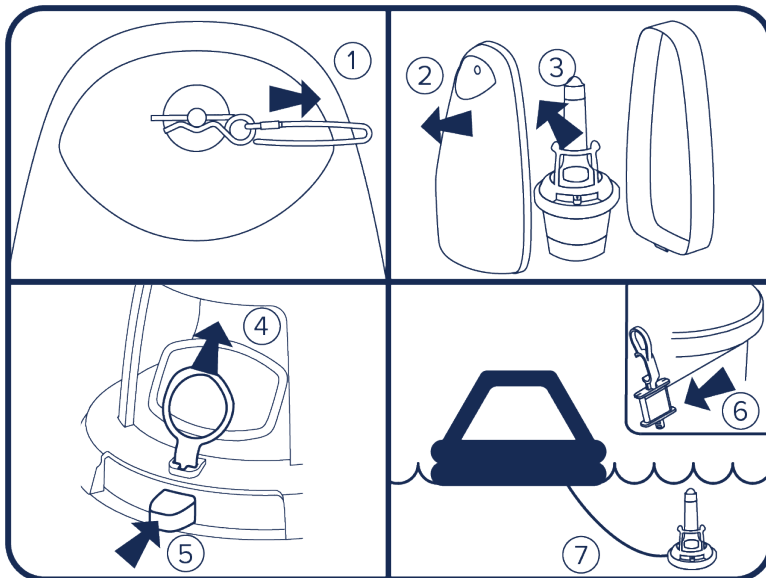

raft, or under a cover or canopy. Do NOT tie the lanyard to the ship in distress, as this will prevent the unit from functioning if the ship sinks.

1. Remove the locking pin from the front cover.
2. Remove the front cover.
3. Take the EPIRB out of the bracket.
4. Pull the red tab.
5. Push the switch to activate the EPIRB.
6. Unclip and release the lanyard.
7. Tie the lanyard to yourself or to the life raft.

The strobe light will start flashing indicating that the EPIRB is operating.

If possible, keep the EPIRB in an open area, away from any metal objects (ship construction etc.) that may limit the satellite coverage. Transmissions can be stopped by taking the EPIRB out of water and turning the switch to middle position.

Table of Contents

1	Manual operation and activation	2
2	General	5
3	Operating instructions	6
3.1	Manual activation	6
3.2	Indicator descriptions	7
3.3	Automatic activation.....	10
3.4	Operating scenarios	11
3.5	Self-test	14
3.6	Deactivation of the EPIRB	22
3.7	False alerts	22
4	Product description	23
4.1	Tron 40AIS EPIRB.....	24
4.2	FB-42 or FBH-42 Bracket.....	31
4.3	Return Link Service (RLS)	31
5	Registration, Installation and mounting	32
5.1	Registration of the EPIRB	32
5.2	Change of ownership	33
5.3	Installation.....	33
5.4	Bracket installation and mounting	34
5.5	Mounting the EPIRB in the bracket	35
5.6	Fitting the front cover	37
6	Testing and maintenance	38
6.1	Every month	38
6.2	Every 3 months	38
6.3	Every 12 months	38
6.4	Every 2 nd year	38
6.5	Every 4 or 5 years.....	39
6.6	Every 10 years	39
6.7	Hydrostatic release unit (HRU) replacement	39
6.8	Shore based maintenance (SBM)	41
6.9	Battery expiry date.....	42
7	Technical information.....	43

7.1	General.....	43
7.2	Strobe light.....	43
7.3	Cospas-Sarsat transmitter	44
7.4	GNSS receiver.....	44
7.5	Homing transmitter	44
7.6	AIS transmitter	45
7.7	Brackets.....	45
7.8	Battery information	46
7.9	Cospas-Sarsat system	47
7.10	AIS system	49
7.11	121.5 MHz homing signal	50
7.12	Position receiver (GNSS)	50
7.13	RLS system.....	51
8	Spare parts, warranty and disposal	51
8.1	Accessories and spare parts	51
8.2	Counterfeit spare parts.....	52
8.3	Warranty	52
8.4	Service	53
8.5	Disposal	53
9	Abbreviations and definitions.....	54
10	Ammendment records	55

2 General

Jotron manufactures safety products designed for search and rescue of human lives and property. For this product to be effective according to the design parameters, it is imperative that it is handled, maintained, serviced and stowed in accordance with this manual.

All information contained within this manual has been verified and is to Jotron's knowledge correct. Jotron reserves the right to make changes to any product(s) or module(s) described herein to improve design, function or reliability without further notice.



IMPORTANT

Jotron is not liable and cannot be held responsible for any injury or damages caused directly or indirectly by an error or omission of information, incorrect or misuse, breach of procedures or failure of any specific component or part of this product.

jotron.com.

3 Operating instructions

3.1 Manual activation

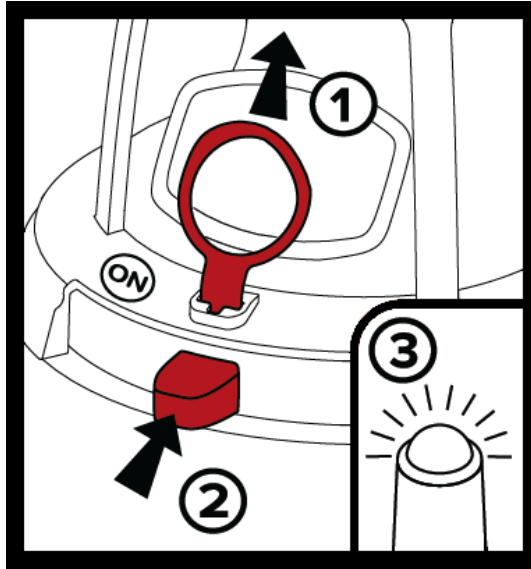

To activate the EPIRB follow these steps:

1. Remove pull tab
2. Push switch



WARNING

Use only in emergency!

3.2 Indicator descriptions

The following tables describes the status of the different indicator lights when the EPIRB is operating normally.

Indicator light descriptions		
Off	The LED is off	●
On	The LED is on	○
Triple flash	The LED flashes fast in sequences of 3 consecutive flashes	○○○ ○○○ ○○○
Steady flash	The LED flashes periodically with a long flash	○ ○ ○
Multiple short off periods	The LED is turned off for short periods, creating a blink effect. (Negative blink, occulting blink)	●●●●
Multiple flashes	The LED flashes multiple times	○○○

3.2.1 Strobe light



When the EPIRB is activated the strobe light will start flashing steadily with approximately 21 flashes per minute.

The first 406 MHz signal will be transmitted 60 seconds after activation. This is indicated with a triple flash.

After approximately 4.5 minutes the first AIS signal is transmitted. This is indicated with a double flash. At the same time the 121.5 MHz homing signal will start transmitting.



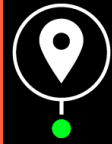

	 Strobe light		
EPIRB active	○	○	○
		Steady flashes	
406 MHz signal transmitted	○	○○○	○
		Triple flashes	
AIS signal transmitted	○	○○	○
		Double flashes	

3.2.2 Position indicator (GNSS)

	 <p>Position indicator</p>
Waiting for position	 <p>Triple flashes</p>
Position achieved	 <p>Steady flashes</p>

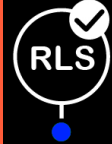
3.2.3 RLS indicator (if enabled)

Confirmation that the distress signal has been detected and received. See chapters 4.3 and 7.13 for more information.

	 <p>RLS indicator</p>
Waiting for RLS	 <p>Triple flashes</p>
RLS acknowledged	 <p>Steady flashes</p>
RLS disabled (EPIRB is not equipped with RLS protocol)	 <p>No light</p>

3.2.4 Test indicator

The test indicator is not active during normal activation of the EPIRB.

3.3 Automatic activation

3.3.1 Float-free

If the ship is sinking, the EPIRB will be automatically released from the bracket when it has reached a depth of 2-4 meters (6-13 feet) and start transmitting when it has reached the surface.

The transmission will continue until the EPIRB is lifted out of the water and dried off.

3.3.2 Water activation

The EPIRB is designed to automatically activate when deployed into water.

An internal safety function will prevent inadvertent activation caused by moisture, sea spray etc. when located in the bracket.

3.4 Operating scenarios

The EPIRB is designed to give the best distress signal performance when floating in the sea, but there may be situations where the EPIRB is activated elsewhere. To optimize the performance in these situations please follow the instructions in the next sections.

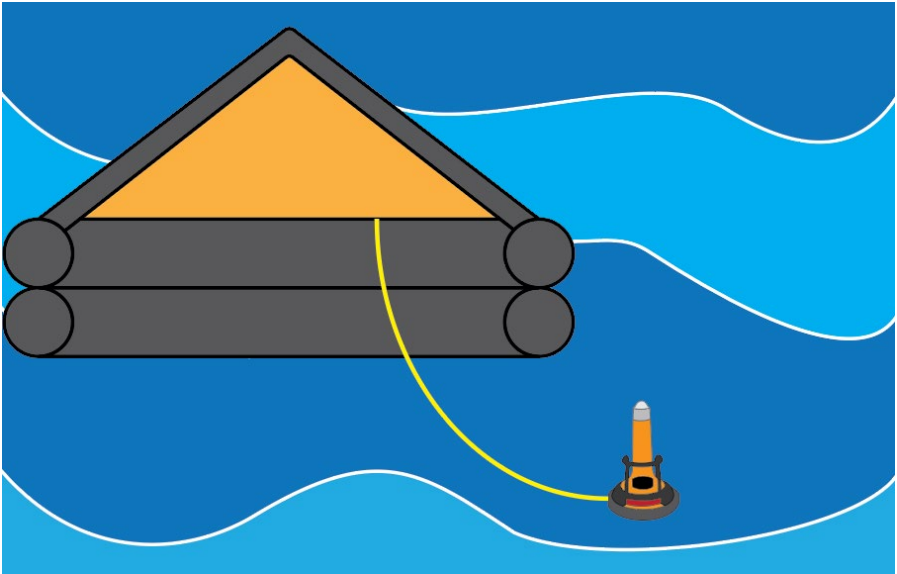

WARNING

Do not obstruct the GNSS antennas view to the sky

3.4.1 In life raft

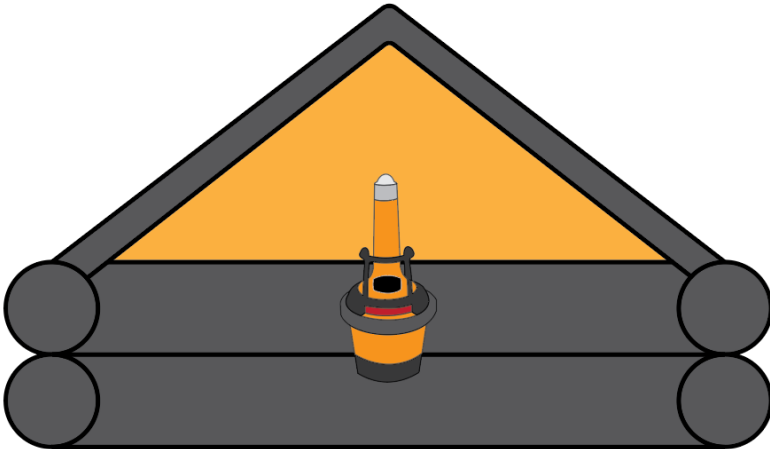

- Try to keep the EPIRBs view of the sky unobstructed.
- It is not recommended to operate the EPIRB under the life raft cover if it is made of materials that may obstruct the signals.
- Keep the antenna facing upwards.

3.4.2 In lifeboat

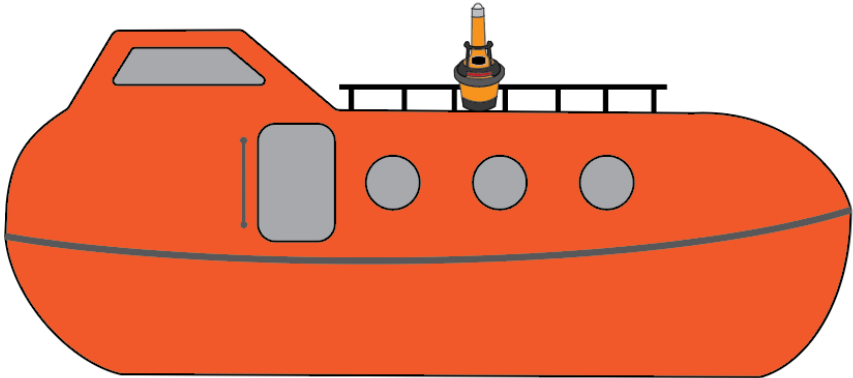

- Try to keep the EPIRBs view of the sky unobstructed.
- It is not recommended to operate the EPIRB under the lifeboat canopy if it is made of materials that may obstruct the signals.
- Keep the antenna facing upwards.
-

3.4.3 Onboard ship

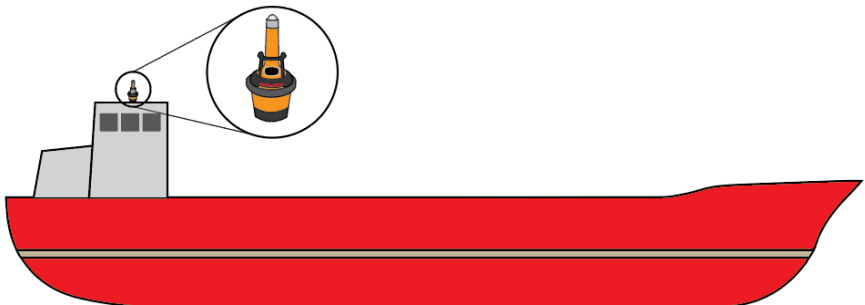

- Keep the EPIRB in an open space.
- Do not place the EPIRB inside, under a roof or other overhead obstructions.
- Do not tie the lanyard to the ship.
- Keep the antenna facing upwards.

3.5 Self-test

Self-tests shall be performed regularly to verify that the EPIRB is working correctly. A self-test will use battery power, so please follow the recommendations in Chapter 5.6 for self-test intervals.

3.5.1 Normal self-test

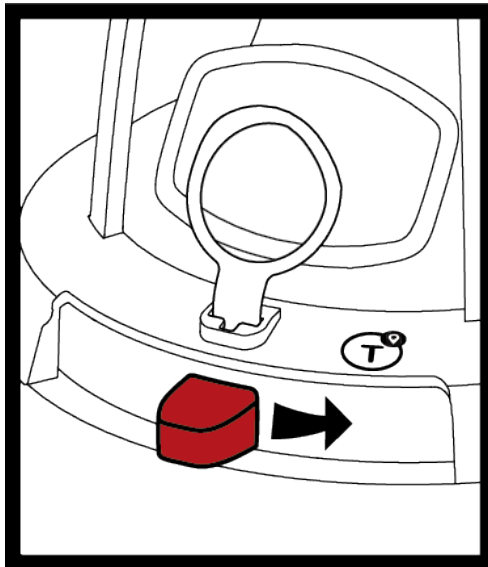

- To start the self-test, move the switch to test position and hold until the test indicator light is on.









During the normal self-test, the main functionality of the EPIRB is tested. A test signal is transmitted on all frequencies (121.5 MHz, AIS and 406 MHz). These test signals will not be recognized as distress signals. While transmitting the test signals the battery and the transmitted signals are tested.

The test indicator will give a short dark period every time a signal is transmitted.

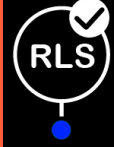
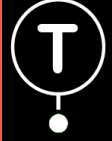
If the RLS protocol is enabled the blue RLS indicator light will light up for approximately 1 second.

The top light will flash once if the self-test is successful.

If the self-test detects a fault in the EPIRB module, the test indicator LED will start flashing at the end of the test. For fault codes see the table in section 0.

 Test sequence	 Position indicator	 RLS indicator	 Test indicator	 Strobe light
Self-test started	-	-	 On	-
Signals transmitted	-	-	 Multiple short off periods	-
RLS enabled *	-	 On for 1 second	-	-
Extended self-test successful	-	-	-	 One flash
If one of the above tests are unsuccessful, the remaining test sequences will not be performed, and the test indicator will indicate self-test failure.				
Self-test failure			 Multiple flashes**	

*For EPIRBs with RLS disabled the RLS indicator will remain off.

**See table in section 0 for on failure indications.

3.5.2 Extended self-test

The extended self-test includes a GNSS test in addition to the normal self-test.

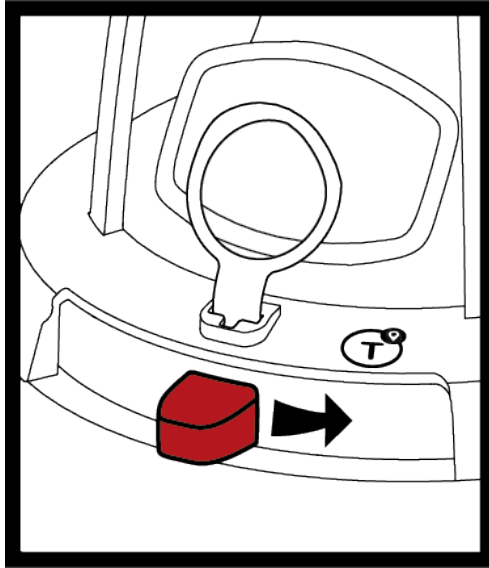

To perform the extended self-test, do the following steps within a period of 3 seconds:

1. Move the switch to test position
2. Release to middle position
3. Move the switch to test position and release when the white test indicator lights up.











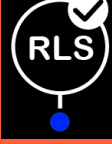
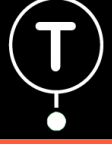

The white test indicator LED will light up and the green GNSS indicator LED will start flashing in sequences of 3 fast flashes. This indicates that the EPIRB is searching for a validated position.

When a valid position is found the green GNSS indicator LED will remain lit for approximately 1 second and a normal self-test will continue.

The top light will flash once at the end of the test if the extended self-test is successful.

If the self-test detects a fault in the EPIRB module, the test indicator LED will start flashing at the end of the test. For fault codes see the table in section 0.

Note that the extended self-test can only be performed 60 times. After that the self-test will indicate “Maximum number of extended self-tests exceeded”.

				
Test sequence	Position indicator	RLS indicator	Test indicator	Strobe light
Extended self-test started	-	-	 On	-
Waiting for position	 Triple flashes	-	-	-
Position achieved	 On for 1 second	-	-	-
Self-test started	-	-	 On	-
Signals transmitted	-	-	 Multiple short off periods	-
RLS enabled *	-	 On for 1 second	-	-
Extended self-test successful	-	-	-	 One flash
If one of the above tests are unsuccessful, the remaining test sequences will not be performed, and the test indicator will indicate self-test failure.				
Self-test failure			 Multiple flashes**	

*For EPIRBs with RLS disabled the RLS indicator will remain off.

**See table in section 0 for on failure indications.

3.5.3 Test failure indications

If one of the sequences in the extended or normal self-test are unsuccessful the test indicator will flash a number of times according to the table below to indicate the occurred failure.

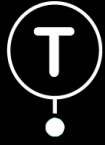
 Number of flashes	Failure indication
2	Battery failure
3	Transmitter failure
4	-
5	No position
6	-
7	Maximum number of extended self-tests exceeded
8	-
9	-
10	Other faults

3.5.4 Test failure descriptions and corrective actions

3.5.4.1 Battery failure

This indicates that the battery capacity is too low, or another critical battery error has been detected. Correct operation cannot be guaranteed anymore. Contact your service partner for battery replacement immediately.

3.5.4.2 Transmitter failure

This indicates that the RF-signal transmitted from the EPIRB is not good and is most probably because the antenna is too close to conductive material, like the bulkhead or railing, or you are holding your hand around the antenna. Place the EPIRB in an open space (minimum 30 cm) and try again. Contact your service partner if this does not help.

3.5.4.3 No position

The GNSS receiver in the EPIRB needs a free view of the sky to get a position within the time limit. Windows and canopies will also reduce the signals from the satellites. Place the EPIRB on a place with free space around (minimum 30 cm) and with a free view of the sky and try again. Contact your service partner if this does not help

3.5.4.4 Maximum number of extended self-tests exceeded

The extended self-test uses a lot of current and is therefore limited to a total of 60 tests. After this the EPIRB will continue to operate as normal in emergency mode and you can still perform normal self-test. However, verification of the GNSS receiver in the EPIRB is not possible until the battery is replaced. Contact your service partner for battery replacement.

3.5.4.5 Other faults

Something is wrong with the configuration of the EPIRB. Contact your service partner immediately.

3.5.5 Testing of the AIS locating signal

During standard self-test mode, the EPIRB will transmit two text messages with the 15HEX ID in one message and the text EPIRB TEST in the other message. The figure below shows this text message as shown on the Jotron TR-8000 MkII AIS.



TR-8000 Secondary Display

59°06.84N SOG --.- kn 08:30:33 UTC
10°06.65E COG ---.-°

Received messages

UTC	Name/MMSI
11.19 09:29	974010063
11.19 09:28	974010063
11.19 09:27	974020042
11.19 09:27	974020042
11.19 08:50	EPIRB AIS
11.19 08:46	EPIRB AIS
11.19 08:46	EPIRB AIS

From: 974020042
UTC: 11.19 09:27 Type: Broadcast Ch: A
EPIRB TEST

Displaying 1-7/8

✕ [Envelope Icon] New Reply [Down Arrow] [Up Arrow] [Home Icon]

When doing GNSS self-test the position messages are also output together with the text messages.

Normally AIS stations will suppress AIS SART test messages but can be configured to display the test information. If an AIS installation is going to be used to verify AIS SART test messages, please consult the equipment manual of the AIS system for more information about this.

3.6 Deactivation of the EPIRB

If the EPIRB has been accidentally activated or to deactivate it after use, remove it from the water and move the switch back to its middle position. Note that it can take up to 15 seconds before the strobe light stops flashing.

3.7 False alerts



False alerts are a serious problem for the rescue service. Nearly 90% of EPIRB initiated distress alerts turn out to be false alarms.

Take the following precautions to prevent inadvertent activation:

- Make sure that the EPIRB is correctly mounted in the bracket.
- Keep the EPIRB dry when it is not mounted in the bracket.
- Keep the EPIRB away from strong magnetic fields.

If your EPIRB is activated in a non-distress situation, or a distress situation which has been resolved and you no longer require assistance, deactivate your EPIRB and contact the nearest SAR authorities to provide them with the following information:

- EPIRB ID number (15 characters UIN).
- Date, time, and position at time of activation. (Time zone)
- Date, time, and position at time of deactivation. (Time zone)
- EPIRB make and model.
- Vessel Name/ID.
- Circumstances/cause of activation (if known).

4 Product description

The main purpose of the Tron 40AIS EPIRB is to alarm the SAR authorities in a distress situation. When activated the EPIRB will transmit a signal, which includes the ID of the ship in distress and the position of the EPIRB. The strobe light will start flashing in both visible and infrared light. See chapter 7.9 for more details on the Cospas-Sarsat system.

The main parts of the Tron 40AIS are:

- Tron 40AIS EPIRB
- FB-42 or FBH-42 Float-free bracket

The EPIRB is buoyant and is equipped with a system that will activate distress transmissions if it is deployed into water. The EPIRB will not be activated if it is exposed to sea spray or rain when mounted in its bracket.

It has been developed to meet the regulations and rules for use on vessels and life rafts in the maritime service. See the Declaration of Conformity document at jotron.com for information on applicable standards.

4.1 Tron 40AIS EPIRB

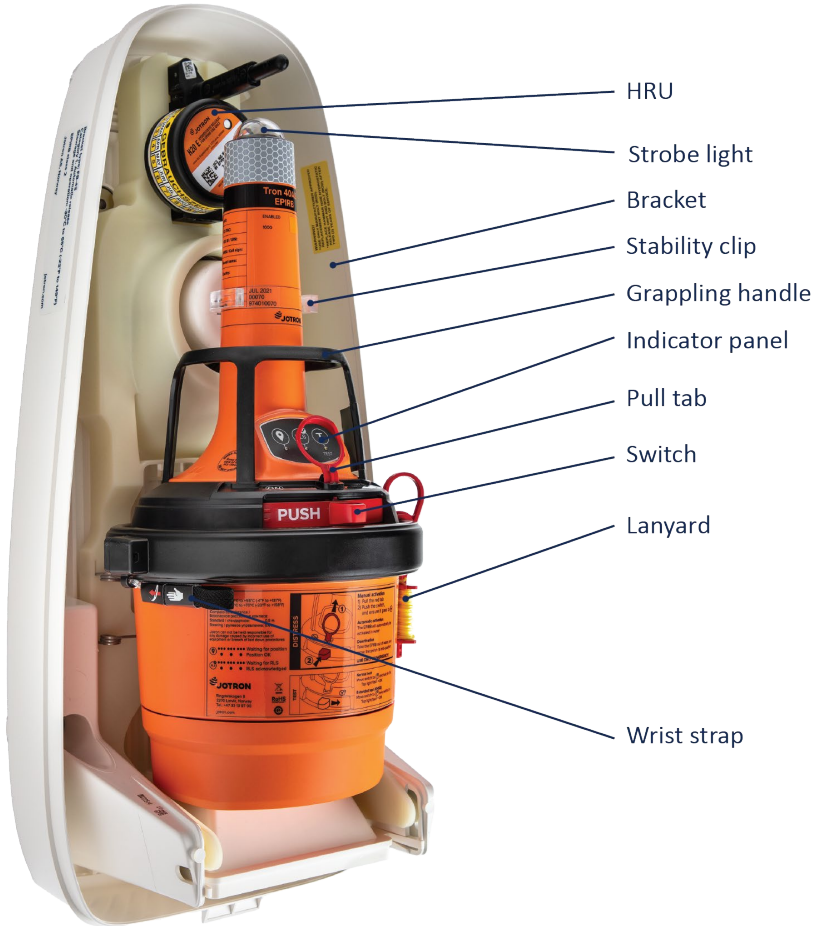

4.1.1 Switch and pull tab





A pull tab is located above the switch and must be removed in order to move the switch to “ON” position. The pull tab does not prevent the switch to move to “self-test” position and must not be removed when performing normal and GNSS self-tests.

The pull tab is removed by pulling firmly upwards. It can be re-fitted and used after it has been removed.

The switch has 3 positions. “ON” position to the left. “Auto / Ready” position in the middle, and “self-test” position to the right. The “ON” position is secured with a pull tab to prevent inadvertent activation.

The switch is spring loaded and will move to “ON” position when pushed with the pull tab removed.

Switch position icons						
Icons						
Description		ON			Normal and GNSS self-test	

4.1.2 Indicator panel

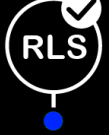
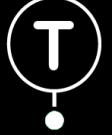

The indicator panel consist of 3 LED indicators with associated icons. See the tables below for descriptions.

Indicator panel icons			
Icons			
Description	Position (green LED)	RLS (blue LED)	Test (white LED)



NOTE

The blue RLS indicator will only be active if the EPIRB has RLS enabled.

4.1.3 Infrared (IR) light

To enhance visibility for SAR teams using night vision goggles and systems, the EPIRB is equipped with an infrared (IR) light in addition to the visible strobe light. The IR light is located at the top of the EPIRB, next to the strobe light, and will start flashing automatically when the EPIRB is activated. The strobe light and the IR light will flash synchronously.

4.1.4 Lanyard



A lanyard is located on the right side of the EPIRB, clipped onto the equator belt.

The purpose of the lanyard is to secure the EPIRB to yourself or the life raft. For optimal performance in an emergency, the EPIRB should be floating in the water.

The end of the lanyard is secured to the EPIRB. To use the lanyard, unclip the lanyard coil from the equator belt and uncoil the line.



Do not secure the lanyard to the ship, as this will cause the EPIRB to follow the ship down if it is sinking.

4.1.5 Wrist strap



The provided wrist strap can be used to carry the EPIRB in situations where it is necessary to have both hands free, e.g., when climbing a ladder. The wrist strap can be pulled out of its pocket, and your hand can be placed through it. Note that it is not possible to put the wrist strap back into its pocket after usage. If the wrist strap is used it should be replaced. Please contact your sales partner.

4.1.6 EPIRB ID information

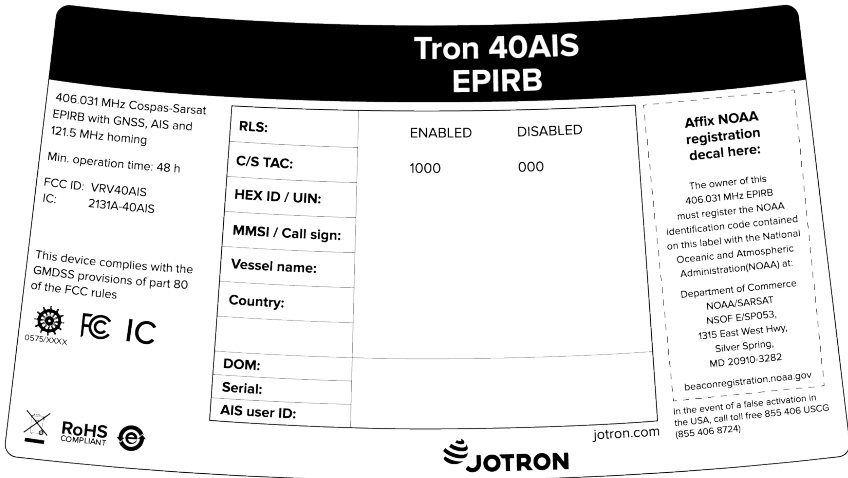

A table with all the ID information is located on the neck of the EPIRB, just below the strobe light. From the factory this table contains information about the date of manufacture (DOM), EPIRB serial number and AIS User ID.

The section showing the TAC number and RLS information is filled out by the dealer or supplier depending on the chosen protocol. The TAC number will have the prefix 1 if the EPIRB is programmed with an RLS protocol.

The dealer or supplier shall use the orange rectangular label included in the box to cover the information that is not applicable.



If the EPIRB has the RLS protocol enabled the label will appear as shown in this figure.¹



If the EPIRB do not have the RLS protocol enabled the label will appear as shown in this figure.¹

The remaining fields showing the ownership of the EPIRB shall be filled in and covered by the blank protection label included in the box.

¹ The TAC number on the EPIRB can deviate from the number shown in the figures.

4.2 FB-42 or FBH-42 Bracket

The float-free brackets (FB-42 or FBH-42) are covered brackets with a HRU which will release the EPIRB if the bracket is submerged to a water depth below 2-4 meters or more.



4.3 Return Link Service (RLS)

This EPIRB has the capability to use the RLS feature, which is available in the Galileo navigation satellite system.

The RLS feature is an indication that confirms to the user that the distress signal has been received and is being sent to the responsible search-and-rescue (SAR) authorities. It does NOT mean that a rescue has yet been organized/launched, only that the distress alert has been received and routed to the appropriate government agencies. See chapter 7.13 for a more detailed description.

5 Registration, Installation and mounting

5.1 Registration of the EPIRB

Your EPIRB must be registered before use. This allows the SAR authorities to retrieve information about you and your emergency contacts in an emergency. Which again enables them to contact you to determine if the distress signal from the EPIRB is a false alarm, and an expensive rescue operation can be avoided.

You should register your EPIRB with the national authority associated with the country code in the hexadecimal identification (15 Hex ID) of your EPIRB. If your country does not provide a registration facility, and has allowed direct registration, you can register your EPIRB online with the Cospas-Sarsat IBRD: www.406registration.com

For information about your country's registration requirements please consult the list of Beacon Registration Contacts on www.406registration.com

From the factory this EPIRB has been programmed with Norwegian country code (258).

5.1.1 Registration in USA

For registration of the EPIRB in USA, use this link:

<http://www.beaconregistration.noaa.gov>

The preferred and easiest way to register, is to use the web page. However, if this is not possible, a filled in registration form can be emailed to:

beacon.registration@noaa.gov

The registration form is available at the US beacon registration website.

The Emergency contact information must be accurate, especially the telephone number, as this will be used to validate the distress signal.

The USCG will only launch an immediate rescue if the approximate location and EPIRB registration details can be confirmed. Otherwise, there will be a delay whilst further signals from the same source are received and verified.

5.2 Change of ownership

If the ownership of the EPIRB is transferred or a change of vessel occurs, the EPIRB must be recoded and re-registered on the new owner in accordance with local rules.

5.3 Installation

The EPIRB should be installed in a location that meets the following requirements:

- The EPIRB should, with greatest possible probability, float-free and avoid being caught in railings, superstructure, etc., if the ship sinks.
- Do not install the bracket near strong magnetic fields that could activate the EPIRB.
- The EPIRB should be located so that it may be easily released manually and brought to the survival craft by one person. It should therefore not be mounted in a radar mast or any other places which can only be reached by a vertical ladder.
- The bracket should, if possible, be installed in a position that will provide as clear a view of the sky as is practical, orientated to facilitate satellite reception.
- Do not install or operate the EPIRB in a location subject to high intensity RF fields. (e.g Radar or communications antennas).
- Be especially aware of interference from shipboard L band transceiver sources such as Inmarsat Fleet Broadband. The emitted signals from such sources are very strong and may influence the GNSS position reception.

The location should be well protected from environmental conditions such as direct sea-spray, chemicals, oil, exhaust and vibrations. - see more detailed information in chapter 4.10 of IMO COMSAR/Circ.32 regarding “Harmonization of GMDSS requirements for radio installations onboard SOLAS ships”.

5.4 Bracket installation and mounting

The mounting footprint is the same for the brackets for Tron 40AIS (FB-42 and FBH-42). Dimensions are shown in the figure below.

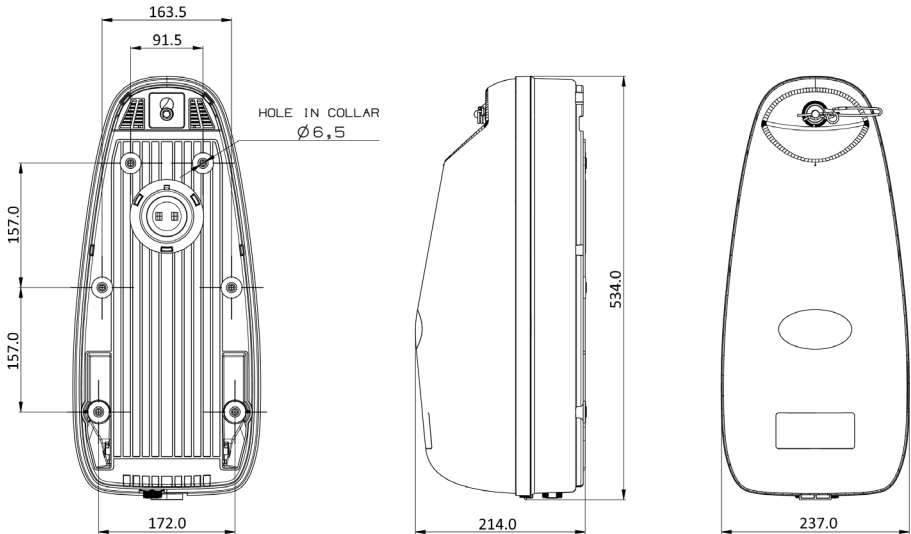

5.4.1 Installation screws

The bracket shall be installed on a flat metal surface with 6 pcs M6 screws with socket head with material quality of A4 (AISI 316). There shall not be used any washer under the screw heads. A washer can block the catapult from releasing. For the pre-mounted vibration dampers to work properly it is important that they are not deformed by the tightening of the screws. If they are deformed, the dampers will not work as designed.

5.5 Mounting the EPIRB in the bracket

5.5.1 Tron 40AIS

1. Make sure the bracket is not damaged.
2. Grab the EPIRB and match the bottom of the battery housing correct on the bracket base and gently press the EPIRB into the stability clip.



3. Place the cover by fitting it from the bottom first. Mount the locking pin to securely hold the cover in place. See chapter 5.6 for details.

If the bracket is mounted correctly, on a flat surface, the EPIRB shall fit in the bracket without any gap in the stability clip.



Correct



Not correct

5.6 Fitting the front cover

To place the front cover; the following steps should be followed:



1



2



3

1. Fit the groove on the front cover with the tab on the bracket.
2. Firmly press the front cover in place before fitting the locking pin through the hole in the hydrostatic release. If the hole is not visible, or you must use force to press down the front cover to see the hole, the tongue and groove is not aligned. Please take the front cover off and try again.
3. Make sure the locking pin is mounted the correct way.

6 Testing and maintenance

To ensure reliability and to minimize the risk of false distress alerting it is important that the EPIRB must undergo testing and maintenance as described in this chapter.

6.1 Every month

- Perform self-test (see chapter 3.5)
- Visual inspection:
 - Make sure that nothing prevents the release function of the EPIRB.
 - Check for defects on the EPIRB and its bracket
 - Make sure that the bracket is not covered by paint or any other chemicals.
 - Check that the lanyard is firmly attached to the EPIRB, and not tied to the vessel or any other objects.
 - Check the expiry date of the HRU. See chapter 6.7 for details.
 - Check the SBM date. See chapter 6.8 for details.
 - Check the expiry date of the battery. See chapter 6.9 for details.

6.2 Every 3 months

- Perform an extended self-test instead of the monthly normal self-test. See chapter 3.5.2.

6.3 Every 12 months

The Tron 40AIS may be under the regulation of the IMO MSC.1/Circ 1040, which requires annual testing performed by authorized radio-surveyor or authorized personnel trained and certified by Jotron.

6.4 Every 2nd year

- Replace the HRU including the plastic bolt. See chapter 6.7 for description.
- Mark a new expiry date on the HRU label.

6.5 Every 4 or 5 years

If the EPIRB has a mandatory requirement of shore-based maintenance, perform complete SBM service or replace the complete EPIRB. See chapter 6.8

The interval is 4- or 5-years dependent on the flag-state administration.

6.6 Every 10 years

Due to the harsh environment the EPIRB normally is situated in, Jotron strongly recommends replacing both the EPIRB and the bracket after 10 years.

6.7 Hydrostatic release unit (HRU) replacement

The hydrostatic release unit shall be replaced within the end of the year and month indicated on the side of the HRU. This is shown in the following figures.



Expiry month location



Expiry year location

Follow these steps to replace the HRU:

1. Release the front cover and remove the EPIRB from the bracket.
2. Press down and hold in place the spring-loaded bracket plate and remove the hydrostatic unit by sliding it out of its locking slot.

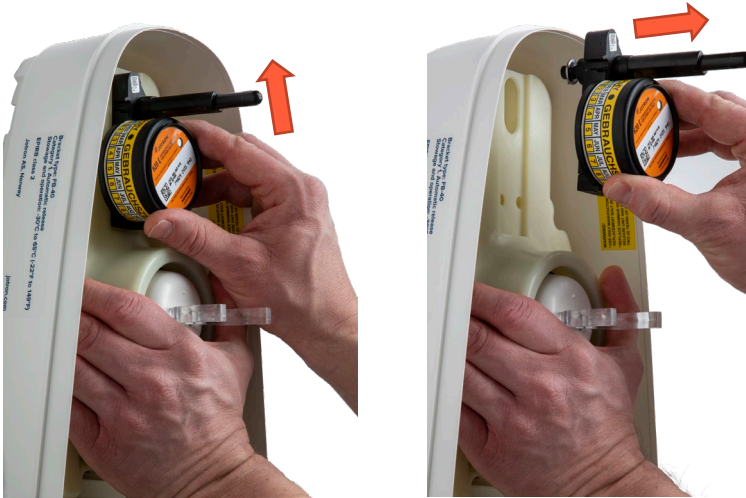

3. Install the new hydrostatic unit while continuing holding down the spring-loaded bracket plate and sliding the unit into its locking slot.
4. Mount the EPIRB in the bracket. See chapter 5.5 for instructions.



WARNING

Only Jotron HRU kit is acceptable for use. Any use of unoriginal spare parts will invalidate the product type approval certificates, and warranty will not apply. It may also compromise your safety.

6.8 Shore based maintenance (SBM)

EPIRBs may have mandatory requirement of Shore Based Maintenance (SBM) either by IMO, SOLAS or national requirements at intervals specified by flag administration, not exceeding 5 years.

If the EPIRB is fitted on a vessel that is subject to SOLAS regulations, shore-based maintenance of EPIRBs should be carried out in accordance with IMO guidelines as set out in MSC/Circ.1039 as amended.

SBM shall be performed latest by the date indicated on the SBM label on the EPIRB, by a Jotron approved SBM partner.

The SBM label is located at the battery housing, and is shown in the figure below:

2026	2027	2028	2029	2030	2031	2032					
Service or SBM shall be performed at the end of the indicated month, and within battery expiry date.			Serviced by:								
1	2	3	4	5	6	7	8	9	10	11	12



IMPORTANT

Only trained personnel certified and authorized by Jotron can perform battery replacement and SBM on the Tron 40AIS.

6.9 Battery expiry date

The battery expiry date can be found on a label located on the right side of the battery housing, behind the lanyard.

The battery must be replaced within the end of the indicated month and year. However, Jotron strongly recommends replacing the complete EPIRB after 10 years.



7 Technical information

7.1 General

Tron 40AIS:	
EPIRB Class:	Class 2
- Operating temperature:	-20° C to 55° C (-4° F to 131° F)
- Stowage temperature:	-30° C to 70° C (-22° F to 158° F)
EPIRB Category:	Category 1 - Float-free automatically activated EPIRB
EPIRB Group:	Group 3 - Includes AIS transmitter and 121.5 homing transmitter
Housing material:	Glass reinforced polycarbonate
Height:	397 mm
Width:	200 mm
Weight:	1.9 kg
Standard compass safe distance:	0.8 m
Steering compass safe distance:	0.8 m
Battery operating time:	More than 48 hours at -20° C
Lanyard length:	5 to 8 m
Lanyard tensile strength:	More than 25 kg

7.2 Strobe light

Infrared (IR) light	
Wavelength:	770-890 nm
Intensity:	More than 2.5 mW/sr
Flash rate:	21 flashes per minute

Visible light	
Color:	White
Intensity:	More than 0.75 cd
Flash rate:	21 flashes per minute

7.3 Cospas-Sarsat transmitter

Cospas-Sarsat transmitter	
Frequency:	406.031 MHz
Output power:	5W
Protocols:	Maritime, Serialized, Radio Call Sign
Modulation	Phase modulation
Data encoding	Bi Phase L
Short term stability	Less than 2×10^{-9}
Medium term stability	Less than 10^{-9}
Residual noise:	Less than 3×10^{-9}
Bit rate:	400 b/s
Antenna:	Omni directional

7.4 GNSS receiver

Navigation device	
Supported GNSS constellations:	GPS, GLONASS, Galileo
Antenna polarization:	RHCP

7.5 Homing transmitter

Homing transmitter	
Frequency:	121.500 MHz
Output power:	Up to 100 mW
Modulation:	AM sweep tone (A9) Sweep range: 700 Hz Sweep rate: 2.5 Hz Emissions designator: 3K20A3X
Stability:	10 ppm over temperature range
Antenna:	Omni directional

7.6 AIS transmitter

AIS transmitter	
Frequency:	161.975 MHz (AIS 1) 162.025 MHz (AIS 2)
Output power:	1 W
Modulation:	GMSK
Stability:	±1 KHz
Antenna:	Omni directional

7.7 Brackets

7.7.1 FB-42 Float-free bracket

FB-42	
Material:	Glass reinforced ASA
Dimensions:	215 x 553 x 236 mm
Weight:	3.1 kg
Release mechanism:	Jotron HRU kit
Storage and operation temperatures:	-30° C to +65° C (-22° F to +149° F)

7.7.2 FBH-42 Float-free bracket with heating

FBH-42	
Material:	Glass reinforced ASA
Dimensions:	215 x 553 x 236 mm
Weight (including thermostat):	4 kg
Release mechanism:	Jotron HRU kit
Storage and operation temperatures:	-30° C to +65° C (-22° F to +149° F)

7.8 Battery information

Capacity:	7.2 V / 7.2 Ah
Lithium metal content:	Below 1 gram per cell
Approximate weight:	51 g per cell
Chemical system:	Lithium metal
Battery life:	5 years *

*) Exact date is printed on the battery expiry label. See chapter 6.9.

7.8.1 Battery safety

Due to risk of fire or explosion the batteries shall not be short-circuited, recharged, punctured, incinerated, crushed, immersed, forcibly discharged or exposed to temperatures above the declared operating temperature range of the product. The batteries in this EPIRB are sealed units which are not hazardous when used according to the recommendations of the manufacturer. Under normal conditions of use, the batteries are hermetically sealed.

For information regarding the physical and chemical properties, the potential health and safety measures and the environmental effects of the battery used with this product, refer to the manufacturer's safety information documentation.

The safety information is available for download at [jotron.com - product](http://jotron.com/product/tron-40ais/).
<http://jotron.com/product/tron-40ais/>

The product described in this manual is subject to follow special packing instructions and/or transportation regulations. See chapter 8.3.1 for details.

7.8.2 Handling and storage

Store in a cool, well ventilated area.



If this EPIRB is kept above room temperature for prolonged periods of time then the battery capacity will be degraded and either the battery should be replaced earlier than the date stated on the EPIRB, or the quoted 48 hours operating life of the EPIRB may be reduced. The effect is more pronounced as the temperature increases

In locations that handle large quantities of lithium batteries, such as a warehouse, lithium batteries should be isolated from unnecessary combustibles.



The battery can explode or leak and cause burns if it is disassembled, charged, installed with reversed polarity, or exposed to water, fire or high temperatures.

7.9 Cospas-Sarsat system

The Cospas-Sarsat system was created to detect and locate emergency beacons activated by aircrafts, ships, and people in remote areas.

The system was introduced in 1982 as a worldwide search and rescue system with the help of satellites covering the earth's surface. Since the introduction of the system tens of thousands persons have been rescued.

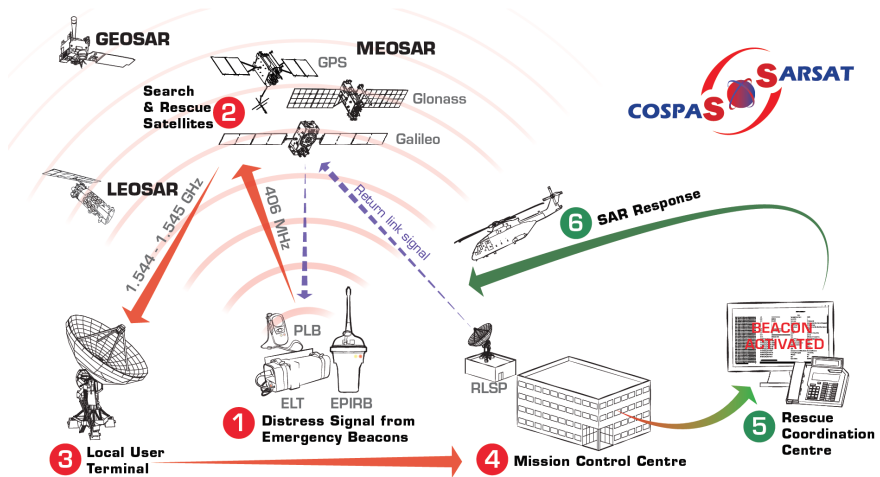

When the Tron 40VDR AIS is activated (1), the next passing satellite (2) will detect the transmitted signal and relay it to an antenna at a LUT (3). The signal will be routed from the LUT to an MCC (4). The MCC will then relay the signal to the appropriate rescue coordination center (5) that will organize the rescue operation (6).

The system consists of:

- Satellites in low-altitude earth orbit (LEOSAR), geostationary orbit (GEOSAR) and medium latitude earth orbit (MEOSAR), that process and/or relay signals transmitted by beacons.
- Local user terminals (LUT) that receives and processes the signals from the satellites.
- Mission control centers (MCC) that distributes the signals to the appropriate search and rescue authorities.

Each EPIRB must be programmed with its own unique code in the system to identify the ship in distress. It is important that the EPIRB is registered in the database for the applicable country. See chapter 5.1 for more details.

The LEOSAR system has good coverage worldwide, including polar regions, and calculates the location of an activated EPIRB using Doppler processing techniques.

The GEOSAR system has good coverage worldwide, except for polar regions and can identify an activated EPIRB within a very short time. The system cannot calculate the location of the EPIRB but can use the EPIRBs GNSS receiver to provide a position.

The MEOSAR system provides very good coverage worldwide. The position is calculated using the time delay between when the signal is sent from the EPIRB to it is received by the satellites, and the distance between them.

For more information see: <https://www.cospas-sarsat.int/en/>

7.10 AIS system

The EPIRB is capable of transmitting alert messages compatible with the Automatic Identification Systems (AIS) found onboard all SOLAS vessels and many other vessels. The transmission of these signals starts automatically after activation of the EPIRB. A burst consisting of eight messages are transmitted each minute with position velocity and course. These messages are received and plotted on AIS systems. They are distinguished from other vessels and are given special priority and alarm status.

Every 4 minutes a special text message containing the 15 HEX ID of the EPIRB and the text “EPIRB ACTIVE” is transmitted. These messages will be displayed immediately when received by an AIS installation.

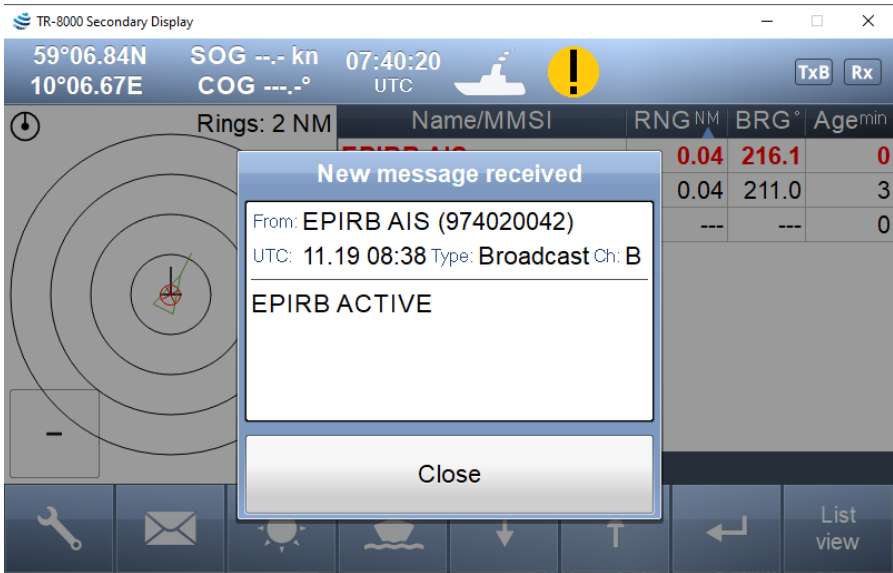

The above figure shows this message as displayed on an Jotron TR-8000 MkII AIS.

7.11 121.5 MHz homing signal

The EPIRB transmits a sweep tone homing signal on 121.5 MHz that can be detected by overflying airplanes and the SAR vessels.

7.12 Position receiver (GNSS)

Jotron EPIRBs have a built in GNSS receiver capable of receiving position signals from GPS, GLONASS and Galileo satellite systems. The position is encoded by the message generator of the EPIRB and transmitted to the Cospas-Sarsat satellites. The GNSS position and the position calculated by the Cospas-Sarsat system itself will together give a precise indication of the actual position.

In addition, the position data from the GNSS receiver will be used in the AIS homing signal visible for all nearby AIS receivers.

The position fix is updated each 5 minutes for both Cospas-Sarsat messages and AIS messages and reflected in the next transmission.

7.13 RLS system

This EPIRB sends a Return Link Service status together with the distress signal on 406 MHz when it is activated. When this message is received by the ground station, an acknowledge signal is returned to the EPIRB through the Galileo position system. The EPIRB receives this acknowledge signal through its GNSS module. In this way the user can be informed that the distress signal has been received and localized.

To enable the RLS feature the EPIRB needs to be configured with a Cospas-Sarsat RLS protocol. You can check your 15 HEX code on this webpage <http://www.cospas-sarsat.int/en/pro> and look for the link “Beacon Message Decode Program” to check if you have an RLS protocol coded in your EPIRB.

The RLS feature is designed to send an acknowledgment to the user in less than 30 minutes from EPIRB activation. Alerting of the distress to SAR authorities is independent of (and may occur before) the RLS acknowledgment indication on the EPIRB. This specification is described in the Galileo SAR Service Definition Document:

<https://www.gsc-europa.eu/sites/default/files/sites/all/files/Galileo-SAR-SDD.pdf>

RLS is an optional function and may not be permitted in all countries or for all EPIRB types. You may visit the web page “Countries Allowing RLS Beacons” to learn the most recent information about national support for RLS:

<https://cospas-sarsat.int/en/beacon-ownership/rls-enabled-beacon-purchase>

8 Spare parts, warranty and disposal

8.1 Accessories and spare parts

For an overview of the available spare parts for this product, refer to the product information page on jotron.com or contact your sales partner.

8.2 Counterfeit spare parts

Jotron is aware of extended counterfeit spare parts being marketed and sold to fit GMDSS safety products. It is of extreme importance that any spare parts being fitted to this product are original spare parts, manufactured or approved by Jotron. Any use of counterfeit spare parts will invalidate the product type-approval certificates and warranty will not apply.

8.3 Warranty

All Jotron products are warranted against factory defects in materials and/or workmanship during the warranty period.

Refer to the sales terms and conditions for specific warranty information regarding this product.



Use of any counterfeit spare parts will invalidate your warranty and may compromise your safety.

For product support contact: support@jotron.com



Keep the original packing material as it is required if the EPIRB is shipped for service. Special hazardous goods requirements apply for packaging and labelling when shipping batteries.

8.3.1 Transportation

The product described in this manual is subject to follow special packing instructions and/or transportation regulations. Information regarding these regulations (in accordance with ICAO/IATA, IMDG code and/or ADR/RID) is included in the product safety information (PSI) and/or in the test summary report (TSR) (in accordance with UN test 38.3.5) and available for download at [jotron.com - product](http://jotron.com-product).

<http://jotron.com/product/tron-40ais/>

8.4 Service

All services such as testing, installation, programming, replacement, marking and battery exchange are provided by an authorized Jotron service agent.

Improper service or maintenance may destroy the functionality and/or performance of this product.

Jotron does not accept any responsibility for the dismantling or reassembling of any Jotron product that occurs externally from a Jotron authorized facility and/or is handled by someone other than an authorized, training and certified person.

8.4.1 Service agents

Refer to jotron.com for an overview of Jotron partners and distributors.

<https://jotron.com/partners-and-distributors/>

8.5 Disposal

To prevent false alarms, it is important that the battery is removed from the EPIRB when it has reached the end of its life.

All parts of the EPIRB should be disposed of in a way that is not harmful for the environment. It should not be disposed as normal waste and must be handled in accordance with the applicable federal, state, and local waste disposal regulations in the country where the equipment is used.

See jotron.com for updated instructions on disposal.

9 Abbreviations and definitions

AIS	Automatic Identification System
COMSAR	Committee on Radiocommunications and Search and Rescue
COSPAS	COsmichskaya Sistyema Poiska Avariynich Sudov (Space System for the Search of Vessels in Distress)
EPIRB	Emergency Position Indicating Radio Beacon
GEOSAR	Geostationary Search And Rescue
GMDSS	Global Maritime Distress and Safety System
GNSS	Global Navigation Satellite Systems
IBRD	International Beacon Registration Database
IEC	International Electrotechnical Commission
IMO	International Maritime Organization
LED	Light Emitting Diode
LEOSAR	Low Earth Orbiting Search And Rescue
LUT	Local User Terminal (Ground Station)
MCC	Mission Control Centre
MEOSAR	Medium Earth Orbiting Search And Rescue
MHz	Megahertz
NOAA	National Oceanic and Atmospheric Administration (USA)
RCC	Rescue Coordination Centre
RLS	Return Link Service
SAR	Search And Rescue
SARSAT	Search And Rescue Satellite Aided Tracking System
SBM	Shore Based Maintenance
SOLAS	Safety of Life at Sea (An international maritime safety treaty)

10 Ammendment records

Rev	Date	Reason for Issue	Author
A	10.06.21	First release	EJ
B	15.09.21	Updated chapter 3.1.6 and tables in 5.5.1 and 5.5.2	EJ
C	27.09.21	Corrected wrong reference	EJ
D	16.11.21	Updated descriptions on expiry dates in chapter 6 and 7.7	EJ
E	10.12.21	Released for production	EJ
F	10.02.22	Added info about IR-light. Updated photos	EJ



NORWAY / HEADQUARTERS

Jotron AS
Ringdalskogen 8
3270 Larvik, Norway
Tel: +47 33 13 97 00

SINGAPORE

Jotron Asia Pte. Ltd.
10 Ubi Crescent, Ubi Techpark
Lobby B, #05-11/12, Singapore 408564
Tel: +65 65 42 63 50

USA

Jotron USA, Inc
6300 Rothway Street, Suite C
Houston, TX 77040, USA
Tel: +1 713 268 1061

UK

Jotron UK Ltd.
Crosland Park, Cramlington
NE23 1LA, UK
Tel: +44 1670 712000

CHINA

Norway Jotron AS Beijing
Representative Office (ATC business)
No. 1204 room, building D
Tiejian plaza,
Chaoyang district Beijing 100012 China
Tel: +86 10 5619 6464

sales@jotron.com

jotron.com