

# Zodiac Seacom 150 VHF Marine Radio

## INSTRUCTION MANUAL

- Weather Channel Receive, Vibration Draining Function
- IPX7 Waterproof (1 meter depth for 30 minutes)
- Built-in GPS, Built-in DSC, MOB Function

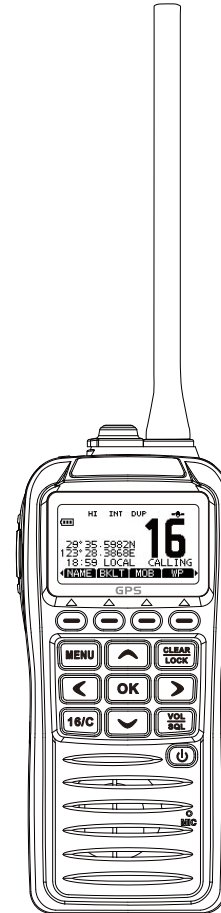

## Foreword

Thank you for purchasing this VHF marine radio. You will find the professional and humanized design of the radio during using. Please read all instructions carefully and completely before using.

It is a multifunctional and well-designed VHF marine radio which meets the IMO (International Maritime Organization) regulation.

This radio has built-in GPS, can indicate ship latitude and longitude, time and other information. It has navigation and MOB functions.

The built-in digital selective call DSC function can achieve all kinds of DCS call including distress call.

As adopting advance waterproof technology, the radio is with good waterproof performance, can float and flash alarm when drops into the water.

## CAUTION

- The power supply of this radio is DC 7.4V. Please use the lithium battery as configured.
- The radio should be charged by the configured adaptor.
- Do not expose the radio to direct sunlight for a long time. Do not place it in environment or near any heating devices below  $-20^{\circ}\text{C}$  or above  $+55^{\circ}\text{C}$ .
- Stop using and contact the local dealer if the radio emits strange odor or smoke.
- Do not transmit without antenna installed, or the devices will be damaged.
- Please power off in flammable and explosive environment.
- Keep the radio at least 1 meter away from your vessel's magnetic navigation compass.
- The radio meets IPX7 waterproof requirement. However, once the radio has been dropped, waterproof protection cannot be guaranteed because of possible damage to the radio's sealed structure.
- Make sure the radio antenna, earphone jack cover and battery cover are dry before attachment. Or the radio inner components will be damaged.
- Do not put the battery into the water individually. Do not short-circuit the battery.

## ■ Suggestion

Clean the radio thoroughly with fresh water after exposure to salt water. Dry it before operating. Otherwise the radio keys and control components may be unusable due to salt crystallization.

DO NOT submerge the radio in water. The waterproof protection may not be effective if the rubber ring of battery cover or earphone jack cover is damaged in unexpected accident. Please contact with local dealer if they are damaged.



## ■ FEATURES

### ◆ Water-resistant Production

The radio water-resistant protection meets IPX7 requirements. Can be 1 meter depth in water for 30 minutes. Use the battery, earphone jack cover and antenna as configured. Make sure install well and tight.

### ◆ Float

The radio will float, make "Di Di..." alarm sound and send out flash alarm when drops into the water. The display indicates "WATER IS DETECTED".

The radio can float in fresh or salt water with the standard accessories - battery, belt clip and antenna.

When a third-party battery, belt clip and antenna etc. are used, the radio may sink and leak.

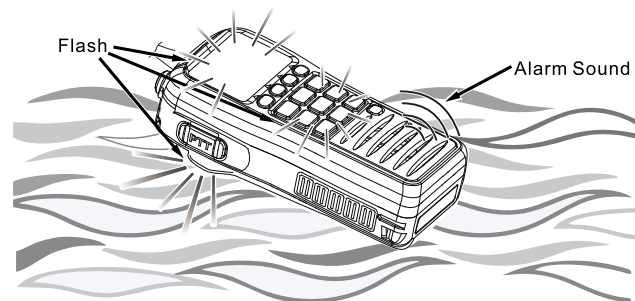

# CONTENTS

## PREPARATION

Supplied Accessories .....	1
Preparation .....	1
Charge the Battery Pack .....	1
Install/Remove Battery Pack .....	2
Install/Remove Antenna .....	3
Install Belt Clip .....	3
Install Earphone/Programming Cable .....	3

## GET ACQUAINTED

Appearance .....	4
Display Screen .....	5
Softkey .....	6
Select Softkey .....	6
Softkey Function .....	6

## BASIC OPERATION

Power ON/OFF .....	7
Adjust the Volume Level .....	7
Adjust the Squelch Level .....	7
Transmit and Receive .....	7
Select Channel Group .....	8
Select Channel .....	8
Channel 16 .....	8
CALL Channel .....	8
Weather Channel .....	8
Edit CALL Channel .....	9

Edit Channel Name .....	9
Monitor Function .....	10
Automatic Backlight .....	10
Key Lock .....	10
Vibration Water Draining Function .....	10

## SCAN OPERATION

Scan Types .....	11
Set TAG Channels .....	11
Set/Cancel Single TAG Channels .....	11
Set/Cancel All TAG Channels .....	11
Scan Operation .....	11

## DUAL WATCH/TRI-WATCH

Description .....	12
Operation .....	12

## DSC OPERATION

Set MMSI Code .....	13
DSC Setting .....	13
Program Position and Time .....	14
Program Individual ID .....	14
Program Group ID .....	14
Delete Individual/Group ID .....	15
Automatic Acknowledgement .....	15
Channel 16 Switch Function .....	16
Alarm .....	16

Channel 70 Squelch Level .....	16
DSC Loop Test .....	17
Channel 70 Watch Function .....	17
Distress Call .....	17
Simple Call .....	17
Regular Call .....	18
Cancel Distress Call .....	19
Receive Distress Call .....	20
Receive Distress Acknowledgement .....	20
Receive Distress Reply Call .....	21
Receive Distress Reply Acknowledgement .....	21
Individual Call .....	22
Transmit Individual Call .....	22
Receive Individual Call .....	23
Transmit Individual Acknowledgement .....	24
Group Call .....	25
Transmit Group Call .....	25
Receive Group Call .....	26
All Ships Call .....	26
Transmit All Ships Call .....	26
Receive All Ships Call .....	27
Geographical Area Call .....	28
Receive Geographical Area Call .....	28
Position Request Call .....	28
Transmit Position Request Call .....	28
Receive Position Request Call .....	29
Transmit Position Reply Call .....	30
Position Report Call .....	31

Transmit Position Report Call .....	31
Receive Position Report Call .....	32
Transmit Position Report Reply Call .....	33
Polling Request Call .....	34
Transmit Polling Request Call .....	34
Receive Polling Request Call .....	35
Transmit Polling Reply Call .....	35
Test Call .....	37
Transmit Test Call .....	37
Receive Test Call .....	38
Transmit Test Acknowledgement Call .....	38
Receive Test Acknowledgement Call .....	39
Received Call Log .....	40
Distress Message .....	40
Other Messages .....	40
Transmitted Call Log .....	41

#### OTHER FUNCTIONS

MOB (Man OverBoard) .....	42
Store a MOB Point .....	42
Check the Stored MOB Point .....	42
Start Navigation to MOB Point .....	42
Edit MOB Point .....	43
Delete MOB Point .....	43
Waypoint .....	43
Store Position .....	43
Store Received Position .....	43
Check the Stored Waypoint .....	44
Sort the Waypoint .....	44

Navigation to Waypoint .....	44
Add Waypoint .....	44
Edit Waypoint .....	45
Delete Waypoint .....	45
Navigation .....	46
Navigation to MOB Point .....	46
Navigation to Waypoint .....	46
Navigation Interface Description .....	46
Compass Interface .....	47
GPS Status Interface .....	47
Sky View .....	47
Satellite Image .....	47
Satellite Signal Strength Interface Description .....	47

UTC Offset .....	51
Noise Cancel .....	51
Inactivity Timer .....	51
Float & Flash .....	51
Monitor .....	51
Unit .....	51

VHF MARINE CHANNEL LIST .....	52
SPECIFICATIONS .....	53
TROUBLESHOOTING .....	54

**MENU INTERFACE OPERATION**

Menu Interface Operation .....	48
Enter Menu Interface Operation .....	48
Menu Items .....	48
Set Items .....	49
Scan Type .....	50
Scan Timer .....	50
Dual/Tri-Watch .....	50
Channel Group .....	50
Weather Alert .....	50
Configuration Items .....	50
Backlight .....	51
Display Contrast .....	51
Key Beep.....	51
Key Assignment .....	51

# PREPARATION

## ■ Supplied Accessories

Carefully unpack the radio. We recommend that you identify items listed in the following table before discarding the packing materials. If any item is missing or has been damaged, please contact the dealer immediately.

Items	Quantity
Antenna	1
Li-ion Battery	1
Desktop Charger (With Screws, Battery Bracket and Rubber Band)	1
AC Adaptor	1
Cigarette Lighter Cable	1
Belt Clip	1
Hand Strap	1
Instruction Manual	1

## ■ Preparation

### ◆ Charge the Battery Pack

#### Charge the radio with battery pack

1. Connect the adaptor output cable with desktop charger; then connect the adaptor with AC power.
2. Insert the radio with battery into desktop charger to charge.

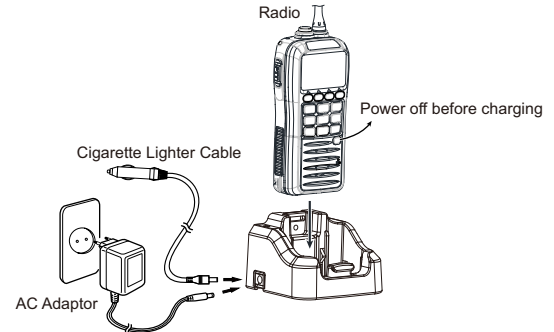

### Charge the battery pack individually

1. Connect the adaptor with desktop charger; then connect the adaptor with AC power.
2. Install the battery bracket into charging groove of desktop charger.
3. Insert single battery pack into desktop charger to charge.

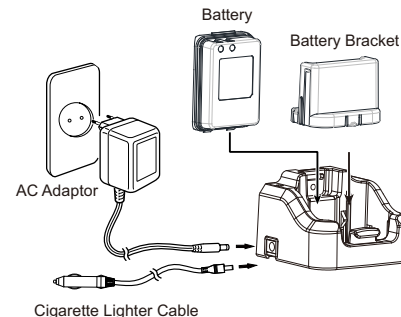

※ NOTE:

- The desktop charger can be fixed on table or wall by configured self-tapping screws. If select fix the desktop charger on wall, please fix the self-tapping screw 1 on wall first, then aim the hole of the charger back to the screw 1 and insert. Make sure the desktop charger insert tight and then lock screw 2.
- Power off before charging.
- The charging indicator light turns red while charging.
- The charging indicator light turns green while full charged.
- Please use the supplied cigarette lighter cable to charge.

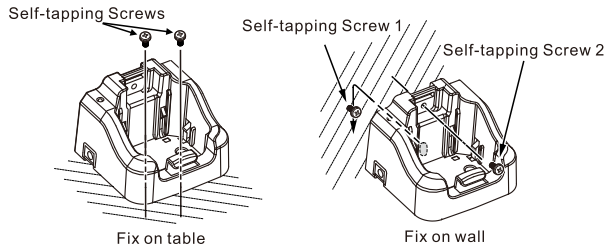

### Fix by rubber band

If the charging environment is shaky, use the rubber band to fix the radio or battery pack. Charging will be more reliable.

1. Use the rubber band cross through the whiffletree of desktop charger.
2. Insert the radio or single battery pack into desktop charger.
3. Use the rubber band cross through radio or battery and twine in the hanger.

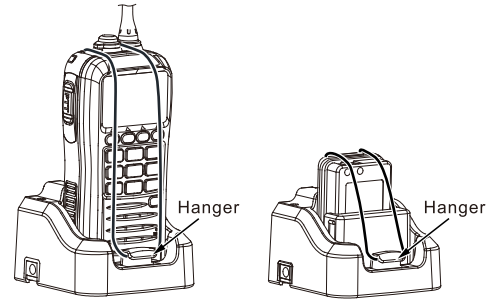
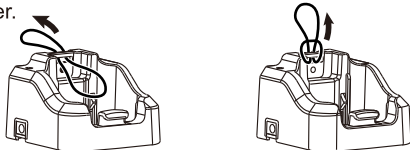

### ◆ Install/Remove Battery Pack

#### Install battery pack

1. Aim the battery terminal at radio power contact. Push the battery into groove.
  2. Press downward the battery. Make sure the battery clip into groove.
- It may cause water ingress if not well install the battery pack.

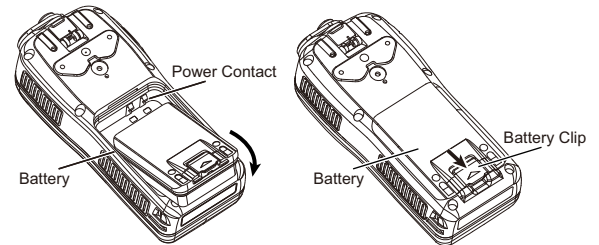

#### Remove battery pack

1. Push the battery clip upward.
2. Lift upward the battery bottom to remove battery pack.



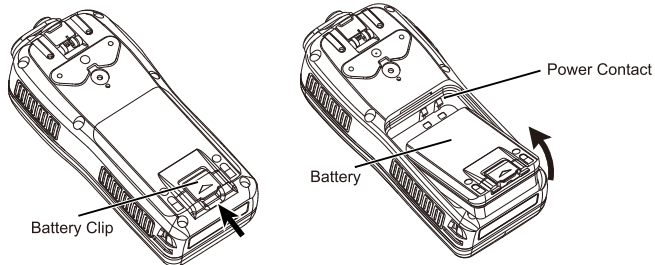

※ NOTE:

- Do not short-circuit the battery terminal or throw it into fire.
- Do not take apart the battery shell by yourself.

◆ Install/Remove Antenna

1. Connect the supplied fixable antenna to the antenna connector; rotate it clockwise until it is tight.
2. To remove it, rotate it counter clockwise.

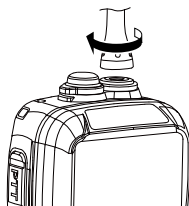

◆ Install Belt Clip

1. Attach the belt clip to radio rear cover. Ensure the screw holes are aligned.
2. Screw tightly using Phillips screwdriver.

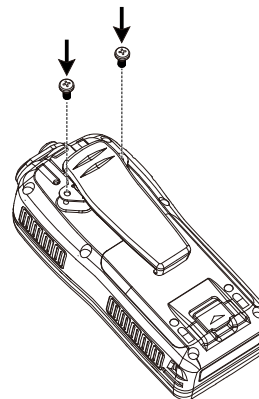

◆ Install Earphone/Programming Cable

1. Open the earphone/programming cable jack cover.
2. Aim the earphone/programming cable at jack. Rotate it tight.
3. Close the jack cover after using to protect the jack.

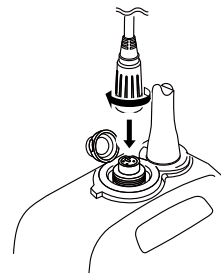

## GET ACQUAINTED

### ■ Appearance

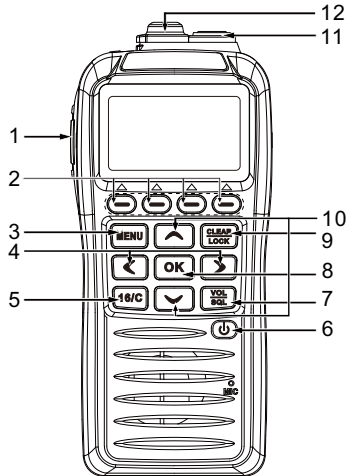

#### 1. [PTT]

- Hold down [PTT] to transmit. Speak with normal tone.
- Release [PTT] to receive.

#### 2. Softkey [←]

Press [←]/[→] to slide the menu in display screen bottom.  
Press these four keys [←] to select. See the Softkey on the next page for more details.

#### 3. [MENU]

Press [MENU] to enter or exit menu interface.

#### 4. [←]/[→]

Press [←]/[→] to switch softkey [←] corresponding menu functions.

#### 5. [16]/[C]

- Press this key to select CH 16.
- Hold on 1 second to select CALL Channel.
- The factory default for Call Channel is Channel 9.
- When the Call Channel is selected, hold for 3 seconds to enter the Call Channel programming mode.

#### 6. Power Key [⏻]

Hold down this key for 1.5 seconds to power on/off the radio.

#### 7. [VOL/SQL]

- In standby mode, press to enter the volume adjustment mode.
- When in volume adjustment mode, press again to enter the squelch adjustment mode.
- Hold for 1 second to active the Monitor Function.

#### 8. [OK]

Press to enter options and set inputting datas.

#### 9. [CLEAR/LOCK]

- Press to return to last interface or cancel the input data.
- Hold for 1 second to turn on or off lock function.

#### 10. [▲]/[▼]

- In standby mode, press to select operation channel.
- In menu mode to select menu and menu setting.
- While in channel scan, press to change the scan direction.

#### 11. Antenna Connector

Connect with 50Ω supplied antenna.

#### 12. [SP MIC]

To connect with optional earphone.

- ※ NOTE: Ensure the cover for the earphone jack is affixed tightly to avoid water ingress

## ■ Display Screen

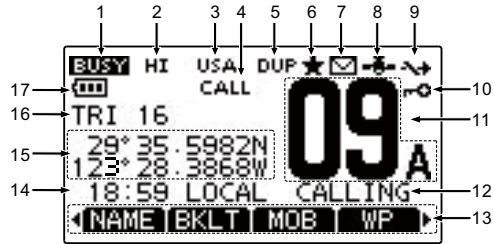

No.	Item	Description
1	Signal Status	<ul style="list-style-type: none"> <li>● BUSY appears while channel is busy.</li> <li>● TX appears while transmitting.</li> <li>● MONI appears while monitor signal is activated.</li> </ul>
2	Power	<ul style="list-style-type: none"> <li>● HI appears while transmitting in high power.</li> <li>● LOW appears while transmitting in low power.</li> </ul>
3	Channel Group	<ul style="list-style-type: none"> <li>● USA appears while USA Channel is selected.</li> <li>● INT appears while International Channel is selected.</li> <li>● CAN appears while Canadian Channel is selected.</li> <li>● WX appears while weather channel is selected.</li> </ul>
4	CALL Channel	<ul style="list-style-type: none"> <li>● CALL appears while CALL channel is selected.</li> </ul>
5	Duplex Channel	<ul style="list-style-type: none"> <li>● DUP appears while duplex channel is selected as operation channel.</li> </ul>
6	TAG channel	<ul style="list-style-type: none"> <li>● ★ appears when TAG channel is selected as operation channel.</li> </ul>
7	Message	<ul style="list-style-type: none"> <li>● ☑ flashes while there is unread messages.</li> </ul>
8	GPS	<ul style="list-style-type: none"> <li>● GPS appears while GPS data and valid position information is received.</li> <li>● GPS flashes while invalid position information is received.</li> </ul>

No.	Item	Description										
9	Power	<ul style="list-style-type: none"> <li>● Appears when "CH 16 SWITCH" is OFF in DSC menu.</li> </ul>										
10	Key Lock	<ul style="list-style-type: none"> <li>● Appears when key lock.</li> </ul>										
11	Channel Number	<ul style="list-style-type: none"> <li>● Indicates operation channel number.</li> <li>● "A" appears when the TX and RX frequencies in selected channel is the same.</li> </ul>										
12	Channel Name	<ul style="list-style-type: none"> <li>● Indicates channel name.</li> <li>● "DSC CHECK" flashes while receiving signals in CH70.</li> </ul>										
13	Softkey	<ul style="list-style-type: none"> <li>● Indicates the programmed function of the softkeys on the front panel.</li> </ul>										
14	Time Zone Indicator	<ul style="list-style-type: none"> <li>● Indicates the current time when GPS data is received or the manually programmed time.</li> <li>● "??" flashes while invalid GPS data is received over 30 seconds.</li> <li>● "??" flashes while manually input GPS data is invalid after 4 hours, and "NO TIME" appears after 23.5 hours.</li> <li>● "LOCAL" appears while the offset time is set.</li> <li>● "NO TIME" appears while no GPS data is received and no time data is manually input.</li> <li>● "MNL" appears while time is manually programmed.</li> </ul>										
15	Position Indicator	<ul style="list-style-type: none"> <li>● Indicates the current position while valid GPS data is received or the position is manually input.</li> <li>● " ?? " flashes while invalid GPS data is received over 30 seconds.</li> <li>● " ?? " flashes while manually input GPS data is invalid after 4 hours, and "NO TIME" appears after 23.5 hours.</li> <li>● "NO POSITION" appears while no GPS data is received after power on.</li> <li>● "NO POSITION" appears when no GPS data is received or no position is manually input.</li> </ul>										
16	Scan Indicator	<ul style="list-style-type: none"> <li>● "SCAN 16" appears during priority scan. "SCAN" appears during normal scan.</li> <li>● "DUAL 16" appears during dual watch. "TRI 16" appears during tri-watch.</li> </ul>										
17	Battery Indicator	<ul style="list-style-type: none"> <li>● Indicate the battery remaining power.</li> </ul> <table border="1" style="width: 100%; text-align: center;"> <thead> <tr> <th>Indication</th> <th></th> <th></th> <th></th> <th></th> </tr> </thead> <tbody> <tr> <td>Battery Level</td> <td>Full</td> <td>Middle</td> <td>Charging Required</td> <td>No Power</td> </tr> </tbody> </table>	Indication					Battery Level	Full	Middle	Charging Required	No Power
Indication												
Battery Level	Full	Middle	Charging Required	No Power								

## ■ Softkey

Several functions can be assigned to the softkeys. When the key function is assigned, the key is displayed above the softkeys. Shown as below.



※ NOTE: The key order may be different from above picture. It can be set by programming software.

### ◆ Select Softkey

Press [◀]/[▶] to switch corresponding [—] softkey. When the key shows "◀" or "▶", press [◀]/[▶] to sequentially displayed all softkey functions.

### ◆ Softkey Function

The softkey function can achieve below functions.

1. **SCAN**  
Press this key to turn ON/OFF normal scan or priority scan.
2. **DW**  
Press this key to turn ON/OFF dual watch or tri-watch.
3. **HI/LO**  
Press this key to select high power or low power. Some channel is set as low power and cannot be changed.
4. **CH/WX**  
Press this key to select normal channel or weather channel.

5. **VIB**  
Press this key to turn on vibration draining function. The microphone will emit sounds and drain the water from the microphone housing.
6. **★**
  - Press this key to set the current channel as TAG channel; Press again to clear TAG channel.
  - Press and hold this key for 3 seconds to clear or set all TAG channels at the current channel group.

※ NOTE: The TAG channel is also called as favorite channel.

7. **NAME**  
Press this key to enter channel name edit mode.
8. **BKLT**  
Press this key to enter display screen and keypad backlight adjustment mode. Then press [▲]/[▼]/[◀]/[▶] to adjust display screen and keypad backlight.
9. **MOB**
  - Press this key to enter "MOB" alarm interface.
  - Press and hold this key for 1 second to store the current position as MOB.
10. **WP**
  - Press this key to enter "WAYPOINT" interface.
  - Press and hold this key for 1 second to store the current position as one waypoint.
11. **NAV**  
Press and hold [MOB], or in the MOB, WAYPOINT interface, press this key to navigate the selective position.
12. **COMP**  
Press this key to display ship course, speed over ground (SOG) and course over ground (COG).
13. **LOG**  
Press this key in DSC call interface to enter "Receive LOG Call".

## BASIC OPERATION

### ■ Power ON/OFF

1. Press and hold (⏻) for 1 second to power on. Enter the normal operation mode.
2. Press and hold (⏻) for 1 second to power off.

### ■ Adjust the Volume Level

The volume level can be adjusted by [VOL/SQL] and [▲]/[▼]/[◀]/[▶] keys.

1. Press [VOL/SQL] to enter volume adjustment mode. Then press [▲]/[▼]/[◀]/[▶] to adjust volume level.
  - "VOL" appears.
  - The radio has 20 volume levels. OFF is closed.
  - If no operation is performed for 5 seconds, the radio will return back to normal operation mode automatically.
2. Press [OK] to set or exit volume adjustment mode.
  - Press [CLEAR] to cancel.

### ■ Adjust the Squelch Level

The squelch level can be adjusted by [VOL/SQL] and [▲]/[▼]/[◀]/[▶] keys. In order to receive better signals and valid scan, the squelch level should be adjust properly.

1. Press [VOL/SQL] to enter volume adjustment mode. Then press [▲]/[▼]/[◀]/[▶] to adjust volume level.
  - The screen flashes "SQL".
  - If no operation is performed for 5 seconds, the radio will return back to normal operation mode automatically.
  - The radio has 11 squelch levels. OPEN is completely open. 10 is the maximum squelch level.

2. Press [OK] to set or exit squelch adjustment mode.
  - Press [CLEAR] to cancel.

### ■ Transmit and Receive

1. Press [HI/LO] to select transmit power.
  - "HI" appears while high power is selected. "LO" appears while low power is selected.
  - Select low power for short range communication. Select high power for long range communication.
  - Some channels are only for low power transmit.
2. Press and hold [PTT]. Speak to the microphone to transmit.
  - "TX" appears.
  - Channel 70 cannot be used for normal transmission.
3. Release [PTT] to receive.
  - "BUSY" appears while receiving signals. The sounds come from microphone.

#### ※ NOTE:

- The radio may be damaged if not install the antenna.
- The radio will monitor Channel 70 every specific time even when standby on operating channel.
- "DSC CHECK" appears when Channel 70 is busy.
- The Channel 70 monitor configuration can be changed in DSC setting.
- The radio has time-out timer (TOT) function. It will stop automatically after continuous transmission for 5 minutes.
- Hold the microphone 5-10cm from the mouth while speaking.
- The power save function is activated while no signal is received for 5 seconds.

## ■ Select Channel Group

This radio contains USA Channel, International Channel and Canadian Channel. Choose the appropriate channel groups in your operating area.

1. Press [MENU].
2. Press [▲]/[▼] to select "Radio Setting".
3. Press [▲]/[▼] to select "CHAN Group" and then press [OK].
4. Press [▲]/[▼] to select desired channel group and then press [OK].
5. Press [EXIT] to exit menu interface.
6. Press [▲]/[▼] to select channel.
  - "DUP" appears while duplex channel is selected.
  - "A" appears while simplex channel is selected.

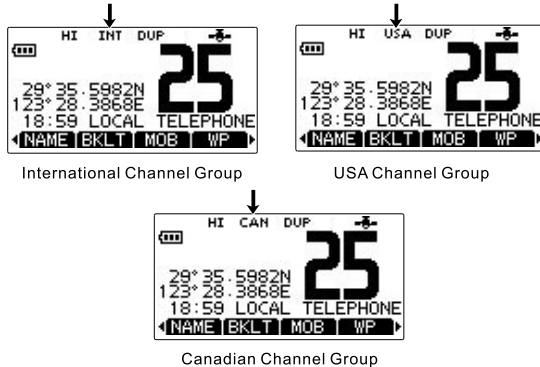

## ■ Select Channel

### ◆ Channel 16

Channel 16 is distress and safety channel. It is used for establishing initial contact with a station and for urgent communications. Channel 16 is monitored during dual watch and tri-watch.

1. Press [16/C] to select Channel 16.

2. Press [CH/WX] to return to the selected channel before Channel 16. Press [▲]/[▼] to select operating channel.

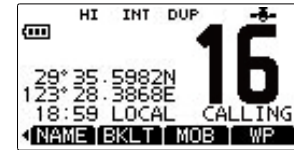

### ◆ CALL Channel

Every channel group has a CALL channel. The CALL channel is monitored by tri-watch. The factory default for CALL channel is Channel 9. It can be reprogrammed.

1. Press and hold [C/16] for 1.5 seconds to select the CALL channel in the current channel group. "CALL" and call channel number appears.
2. Press [CH/WX] to return to the CALL channel before selected operating channel. Or press [▲]/[▼] to select other operating channel.

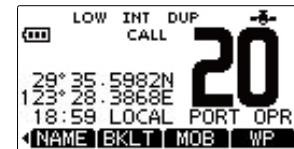

### ◆ Weather Channel

This radio has 10 weather channels.

The radio can detect a weather alert sound automatically in the selected weather channel while receiving and scanning.

#### Select Weather Channel

Press [CH/WX] to select weather channel or normal channel.

- "WX" appears while weather channel is selected.
- "WX☞" appears while weather alert is turned on.

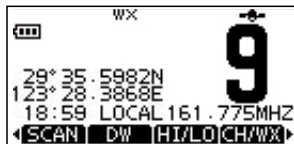

#### Set Weather Alert

1. Press [MENU].
2. Press [▲]/[▼] to select "Radio Settings" and then press [OK].
3. Select "WX Alert" and then press [OK].
4. Select "ON" or "ON with Scan" to set weather alert.
5. Press [EXIT] to exit menu interface.
  - "WX☞" appears for weather alert.

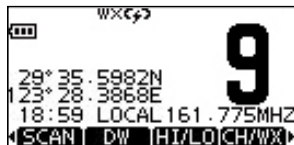

## ■ Edit CALL Channel

A CALL Channel can be edited in each channel group. The factory default is Channel 9.

1. Select a desired programmed channel group (USA, International or Canadian).
2. Press and hold [16/C] for 1 second to select CALL Channel.
  - "CALL" and CALL channel number appear.
3. Press and hold [16/C] for 3 seconds until a long "BEEP" sound and two short "DUDU" sound are heard to enter CALL channel programming mode.
  - Enter CALL channel programming mode interface.

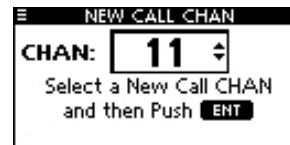

4. Press [▲]/[▼] to select desired channel.
5. Press [OK] to confirm current channel setting as CALL channel.
  - Return to normal operating mode automatically.

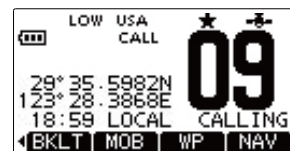

## ■ Edit Channel Name

Each channel can be assigned a unique name up to 10 characters. 26 capital letters, 0-9, symbols (! " # \$ % & ' ()\* +, -. \[ \] ^ \_ ; < = > ?) and space can be input.

1. Press [▲]/[▼]/[◀]/[▶] to select a channel.
  - Cancel dual watch, tri-watch and scan function first.
2. Press [NAME] to open channel name edit interface.
  - A black frame is indicated on the first character.
3. Edit the desired channel name by the following ways.
  - Press [▲]/[▼]/[◀]/[▶] to select desired characters.
  - Press [OK] to confirm.
  - Move the cursor, select "←" or "→" and then press [OK].
  - Select "SPACE", then press [OK] to input a space.
  - Select "DELETE", then press [OK] to delete a character.
  - Press [CLEAR] to cancel and return to the last interface.



4. Repeat Step 3 to input all characters.



5. Press [▲]/[▼]/[◀]/[▶] to select "FINISH". Then press [OK] to set and return to the last interface.

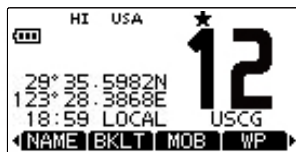

## ■ Monitor Function

Press and hold [VOL/SQL] for 1 second to open monitor function.

- "MONI" appears while this function is activated.

This function can be set to "PUSH" or "HOLD" in the following ways.

1. Select "Configuration" in the "MENU".
2. Select "MONI" to enter "PUSH" or "HOLD" selecting mode.
  - PUSH: The monitor function is activated by holding [VOL/SQL] for 1 second. The squelch keeps opened while holding [VOL/SQL]; closed while releasing.
  - HOLD: The monitor function is activated by holding [VOL/SQL] for 1 second. The squelch keeps opened while holding [VOL/SQL]; closed while pressing any key.

## ■ Automatic Backlight

The automatic backlight function is convenient for night operation. This function can be turned ON/OFF in the set mode.

1. Select [BKLT] to enter backlight adjustment mode.
2. Press [▲]/[▼]/[◀]/[▶] to select backlight brightness level between 1 to 7 or OFF.
  - The factory default for brightness is level 4.
  - The backlight is automatically turned OFF after 5 seconds without operation.

## ■ Key Lock

This function can lock all keys except [PTT], [DISTRESS] and [⏻] to prevent accidental operation of channel and function changes.

- Press and hold [LOCK] for 1 second to turn ON/OFF the key lock function.
- The key lock function is automatically released while DSC call is received or [DISTRESS] is pressed.

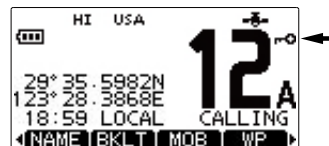

## ■ Vibration Water Draining Function

The vibration water draining function helps to drain the water away from the loudspeaker housing. It can prevent water ingress to affect the loudspeaker voice quality. The radio emits a vibrating sound while this function is activated.

- Press or hold [VIB] to activate vibration water draining function.
- A deep sound emits for 5 seconds to drain water.
- Any key operation is invalid while vibration water draining is activated.
- The vibration water draining function is invalid while connecting with external speaker microphone.



# SCAN OPERATION

## ■ Scan Types

The scan types including normal scan and priority scan, can be selected in the set mode (Please refer to set mode operation).

The weather channel will be scanned also if the weather alert function is activated.

Set TAG channels before scanning. Cancel TAG for channels not need to be scanned.

Normal scan: Scan TAG channels. Channel 16 won't be scanned if it is not set as TAG channel.

Priority scan: Scan Channel 16 during normal scan.

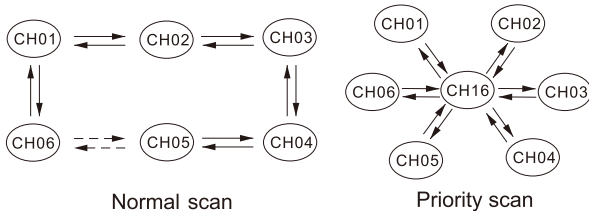

## ■ Set TAG Channels

Set TAG (★) for channels need to be scanned. Cancel TAG (★) which is no need. The untagged channels will be skipped during the scan period.

### ◆ Set/Cancel Single TAG Channel

1. Select the desired channel group.
2. Press [▲]/[▼] to select the desired TAG channel.
3. Press [★] to set the current channel as TAG channel.
  - "★" appears on display.
4. Press [★] again to cancel the TAG channel.
  - "★" disappears on display.

### ◆ Set/Cancel All TAG Channels

1. Press and hold [★] for 3 seconds to clear all the TAG channels at the current channel group.
2. Press and hold [★] again for 3 seconds to set all the current channels as TAG channel.

## ■ Scan Operation

Set scan types, weather alert function and scan resume timer in the menu interface.

1. Press [SCAN] to start normal scan or priority scan.
  - "SCAN 16" appears during priority scan. "SCAN" appears during normal scan.
  - The scan pauses when a signal is received. The scan continues until signal disappear or pause for 5 seconds.
  - Channel 16 is monitored in priority scan. "16" flashes and a "beep" sound emits when a signal is received in Channel 16.
  - Press [▲]/[▼] to change the scan direction.
2. Press [CLEAR] to stop scan. Or press [SCAN] or [PTT].

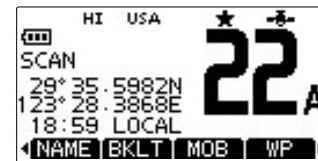

## DUAL WATCH/TRI-WATCH

### ■ Description

This radio contains dual watch/tri-watch function, can be selected in the set mode.

Dual watch: Watch and monitor in turns between the current channel and Channel 16.

Tri-watch: Watch and monitor in turns among the current channel, Channel 16 and CALL Channel.

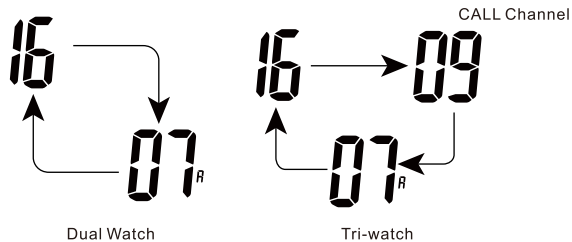

### ■ Operation

1. Press soft key [DW] to start dual/tri-watch.
  - "DUAL 16" appears during dual watch; "TRI 16" appears during tri-watch.
  - A "beep" sound emits when signal is received in Channel 16.
  - Tri-watch switches to dual watch when signal received in CALL Channel.
2. Press [DW] again to cancel.

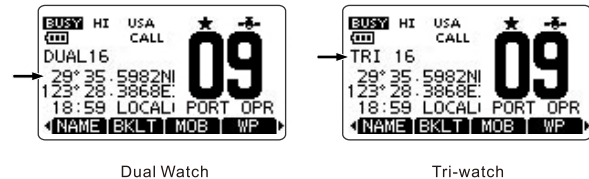

## DSC OPERATION

### ■ Set MMSI Code

The 9 digits MMSI code is also called Maritime Mobile Service Identity. The MMSI code can be programmed by PC programming software or by manually input.

1. Press and hold [⏻] to power ON.
  - Three "beep" sound emits and "No DSC MMSI" appears.
2. Press [OK] to start MMSI code setting.
  - Press [CLEAR] to cancel during the setting and return to normal operation mode.  
The radio cannot make DSC call if cancel setting.
  - Power OFF and then power ON after setting MMSI code.
3. Input MMSI code as the following steps.
  - Press [▲]/[▼]/[◀]/[▶] to select desired number.
  - Press [OK] to confirm.
  - Move the cursor, select "←" or "→" and then press [OK].

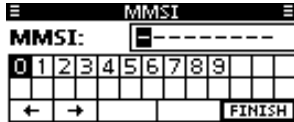

4. Repeat Step 3 to input all 9 digits.
5. "FINISH" will automatically selected after inputting 9 digits.  
Press [OK] to set.
6. "MMSI CONFIRMATION" appears.

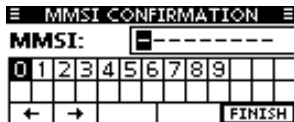

7. Input MMSI code again to confirm. Repeat from Step 3 to Step 5.
8. The screen shows as below while MMSI code is set successfully.  
The radio can do normal operation after setting.



The MMSI code can be checked in menu interface.

※ NOTE: The MMSI code can be set only once. After being set, you should contact with your dealer to set by PC programming software. If your MMSI code has been set, do not need to set again.

### ■ DSC Setting

#### ◆ Program Position and Time

A distress call should include ship position and time. If no GPS data is received, the position and UTC (Universal Time Coordinated) time can be input manually.

- The manual programming is turned OFF automatically while GPS data is received.
- The manual programmed position and time can be held for 23.5 hours.

1. Select "Position Input" in "DSC Settings".
2. Press [▲]/[▼]/[◀]/[▶] to edit latitude and longitude.
  - Press [◀]/[▶] to select desired number.
  - Press [OK] to confirm.
  - Move the cursor to select "←" or "→". Then press [OK].
  - Select N (North Latitude) or S (South Latitude) when the cursor is on the "N" or "S" position.
  - Select W (West Longitude) or E (East Longitude) when the cursor is on the "W" or "E" position.

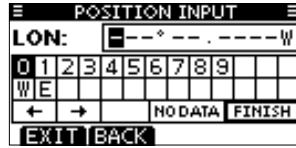
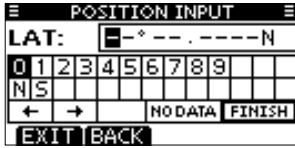

3. Input position information and press [OK] to confirm.
4. In UTC time edit interface, input UTC time as the following ways.
  - Press [◀]/[▶] to select desired number.
  - Press [OK] to confirm.
  - Move the cursor, select "←" or "→". Then press [OK].

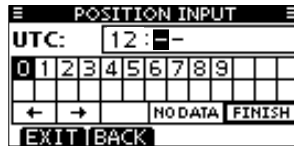

5. Press [OK] to confirm position and time programming.
  - Return to "DSC Settings" interface.

### ◆ Program Individual ID

The radio has 100 programmable DSC address ID. Each ID can be named by 10 characters.

1. Select "Individual ID" in "DSC Settings".
2. Press [ADD] to enter "INDIVIDUAL ID" programming interface.

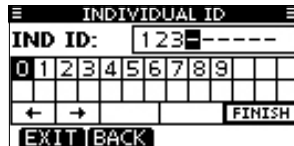

3. Input desired individual ID as the following ways.

- Press [◀]/[▶] to select desired number.
  - Press [OK] to confirm.
  - Move the cursor, select "←" or "→". Then press [OK].
    - ※ If the first digit is "0", it is regard as Group ID.
    - ※ If the first two digits is "0", it is regard as Coast Station ID.
4. Repeat Step 3 to input all 9 digits ID code.
  5. After input 9 digits ID code, press [OK] to confirm. Enter individual ID name programming interface.



6. Input the desired 10 digits ID name as the following steps.
  - Press [▲]/[▼]/[◀]/[▶] to select desired digit.
  - Press [OK] to confirm.
  - Move the cursor, select "←" or "→". Then press [OK].
  - Press [123]/[!\$?]/[ABC] to select character group.
7. Input ID name, press Press [▲]/[▼]/[◀]/[▶] to select "FINISH". Press [OK], "INDIVIDUAL ID" interface appears on display.



8. Press [MENU] to exit Menu interface.

### ◆ Program Group ID

1. Select "Group ID" in "DSC Settings".
2. Press [ADD] to enter "GROUP ID" programming interface.



3. Input desired 10 digits ID as the following ways.
  - Press [◀]/[▶] to select desired number.
  - Press [OK] to confirm.
  - Move the cursor, select "←" or "→". Then press [OK] .
    - ※ If the first digit is "0", it is regard as Group ID.
    - ※ If the first two digits is "0", it is regard as Coast Station ID.
4. Repeat Step 3 to input all 9 digits ID code.
5. After inputing 9 digits ID code, press [OK] to confirm. Enter group ID name programming interface.



6. Input the desired 10 digits ID name as the following steps.
  - Press [▲]/[▼]/[◀]/[▶] to select desired digit.
  - Press [OK] to confirm.
  - Move the cursor, select "←" or "→". Then press [OK].
  - Press [123]/[!\$?]/[ABC] to select character group.
7. Input ID name, press [▲]/[▼]/[◀]/[▶] to select "FINISH". Press [OK], "GROUP ID" interface appears on display.



8. Press [MENU] to exit Menu interface.

### ◆ Delete Individual/Group ID

1. Select "Individual ID" or "Group ID" in "DSC Settings".
  - If no address ID is programmed, "No ID" appears. In this case, press [MENU] to exit Menu interface.
2. Press [▲]/[▼] to select ID name, then press [DEL].



3. Press [OK] to delete ID and return to "INDIVIDUAL ID" or "GROUP ID" interface.
  - Press [CANCEL] to cancel.



4. Press [MENU] to exit.

### ◆ Automatic Acknowledgement

The automatic acknowledgement function can be set as "Auto TX" or "Manual TX".

When an Individual, Position Request, Polling Request or Test Call is received, the radio automatically transmits an Individual Acknowledgement, Position Reply, Polling Reply or Test Acknowledgement call.

When "INDIVIDUAL ACK" is set as "Auto TX", the radio transmits the acknowledgement call including "Unable to Comply" (No Reason Given) automatically.

1. Input "INDIVIDUAL ACK", "POSITION ACK" or "TEST ACK" in "DSC Settings".
2. Press [▲]/[▼] to select "Auto TX" or "Manual TX", then press [OK].

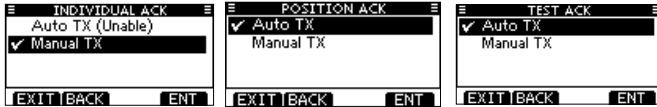

3. Press [EXIT] to return to normal operating mode.

### ◆ Channel 16 Switch Function

As regulation required, the radio will switch to Channel 16 after receiving a Distress call. However, while the setting is OFF, the radio will remain on the operating channel, even after receiving a Distress call.

1. Enter "CH 16 SWITCH" in "DSC Settings".
2. Press [▲]/[▼] to select "Auto (No Delay)", "10 Second Delay" and "OFF", then press [OK].

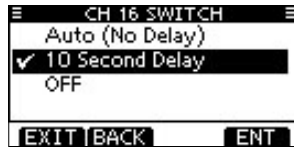

- ※ Auto (No Delay): Press [ACPT] in the confirmation interface after a Distress call is received. The radio will switch to Channel 16 immediately.
- ※ 10 Second Delay: Press [ACPT] in the confirmation interface after a Distress call is received. The radio will remain on the current channel for 10 seconds and then switch to Channel 16 automatically.
- ※ OFF: The radio remain on the operating channel even after a Distress call is received. "No 16" appears.

3. Press [EXIT] to return to normal operating mode.

### ◆ Alarm

Set the Alarm function ON or OFF according to the category or status.

1. Enter "ALARM" in "DSC Settings".
2. Press [▲]/[▼] to select status and then press [OK].
  - Press [BACK] to cancel and return to "DSC Settings".
  - "Safety", "Self-Terminate", "Routine", "Warning" and "Discrete" are selectable.
 Factory default: ON.

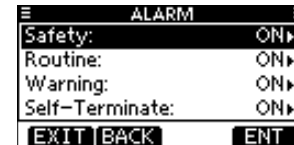

3. Press [▲]/[▼] to set the Alarm function ON or OFF.
4. Press [EXIT] to return to normal operating mode.

### ◆ Channel 70 Squelch Level

The radio has 11 squelch levels between 1~10 and OPEN.

1. Enter "CH 70 SQL LEVEL" in "DSC Settings".
2. Press [▲]/[▼]/[◀]/[▶] to adjust squelch level and then press [OK].
  - Press [BACK] to cancel and return to "DSC Settings".

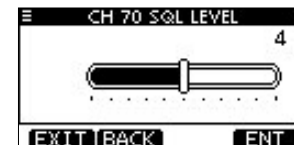

3. Press [EXIT] to return to normal operating mode.

## ◆ DSC Loop Test

The DSC loop test function can send transmit DSC signals to the receive AF circuit to compare and check the TX and RX signals at the AF level.

1. Enter "DSC LOOP TEST" in "DSC Settings".
2. Press [OK] to start DSC loop test.
  - Press [BACK] to cancel and return to "DSC Settings".
  - "OK" appears while the transmit DSC and receive DSC are matched.
  - "NG" appears while either TX or RX DSC circuits has a problem. Please send the radio to the dealer for repair.



3. Press [EXIT] to return to normal operating mode.

## ◆ Channel 70 Watch Function

The radio can select whether watch in Channel 70 or not.

1. Enter "CH 70 Watch" in "DSC Settings".
2. Press [▲]/[▼] to set Channel 70 watch function as "Standby", "Busy", "OFF" and "OFF with Power Save", then press [OK].

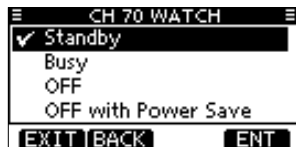

- ※ Standby: The radio will monitor Channel 70 according to the scan speed cycle time while no signal is received.

- ※ Busy: The radio will monitor Channel 70 according to the scan speed cycle time while no signal is received in operating channel. The radio monitor Channel 60 every 1.5 seconds while signal is received in operating channel.
  - ※ OFF: The radio does not monitor Channel 70.
  - ※ OFF with Power Save: The radio does not monitor Channel 70. The power save function is activated while no signal is received.
3. Press [EXIT] to return to normal operating mode.

## ■ Distress Call

A Distress call can be transmitted in the opinion of needs while the ship or person is in distress and requires immediate assistance.

- ※ NEVER make a Distress call if the ship or person is not in an emergency. The Distress call is only used for emergency help.

### ◆ Simple Call

1. Confirm no Distress signal is received.
2. Lift up the key cover at the radio back, press and hold [DISTRESS] for 3 seconds to transmit Distress call.
  - DSC channel (Channel 70) select and transmit distress call automatically.

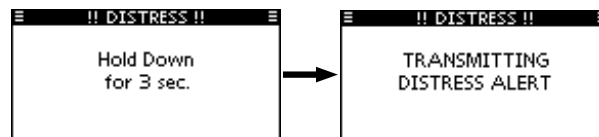

- ※ NOTE: The distress call is paused up to 15 seconds if no valid position data is received. The distress call will be transmitted if valid position data is received within 15 seconds. If valid position data cannot be received within 15 seconds, the distress call will be made by the stored position data.
3. After the distress call is transmitted, the radio will wait for acknowledgement call in Channel 70 for 10 seconds and then wait for a call by alternately monitoring in Channel 70 and Channel 16.

- The distress call will transmit automatically every 3.5-4.5 minutes until a acknowledgement is received (Call Repeat Mode) or DSC call is cancelled.
- Press [RESEND] to repeat the distress call transmission manually.
- Press [◀]/[▶] and then press [INFO] to show the ransmitted distress call information.
- Press [◀]/[▶] and then press [PAUSE] to pause "Call Repeat" mode. Press [RESUME] to resume.



4. Press [ALARM OFF] and then press [PTT] to reply after receiving acknowledgement.
  - ※ A distress alert default contains:
    - Nature of distress: Undesignated distress.
    - Position information: The latest GPS or manual input position data is held for 23.5 hours, or until power OFF.

### ◆ Regular Call

The nature of distress call should be included in distress call.

1. Enter "DISTRESS CALL" in DSC CALLS menu.
2. Press [▲]/[▼], select distress nature. Then press [OK].
  - "Undesignated", "Fire, Explosion", "Collision", "Grounding", "Capsizing", "Sinking", "Out of control/Adrift", "Abandon ship", "Piracy/Armed attack" or "Man overboard" is selectable.
  - The distress nature can store 10 minutes after the selection.

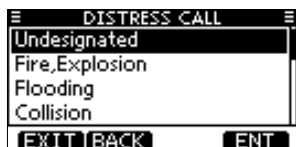

3. Enter distress call confirmation interface.
  - Press [▲]/[▼] to check the hidden lines.

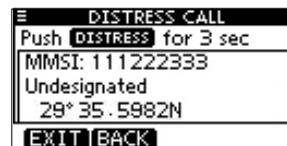

4. Lifting the key cover of the radio back, press [DISTRESS] for 3 seconds to transmit distress call.
  - The radio will emit alarm sound and the backlight flash at the same time while pressing and holding [DISTRESS].
  - The selected distress nature will store for 10 minutes.

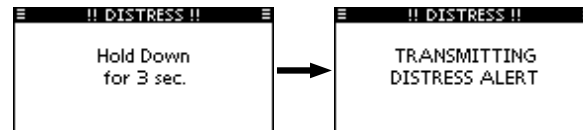

5. The radio will wait for an acknowledgment call after transmitting a distress call.
  - The distress call will transmit automatically every 3.5-4.5 minutes until a acknowledgement is received (Call Repeat Mode) or DSC call is cancelled.
  - Press [RESEND] to repeat the distress call transmission manually.
  - Press [◀]/[▶] and then press [INFO] to show the transmitted distress call information.
  - Press [◀]/[▶] and then press [PAUSE] to pause "Call Repeat" mode. Press [RESUME] to resume.



6. Press [ALARM OFF] and then press [PTT] to reply after receiving acknowledgement.





※ A distress alert default contains:

- Nature of distress: Follow Step 2 to select.
- Position information: The latest GPS or manual input position data is held for 23.5 hours, or until power OFF.

NOTE: When no GPS data is received or invalid data is received, and both position and time are input manually, the screen shown as below. Edit the latitude and longitude position and UTC time as below.



※ Press [CHG] and edit the latitude and longitude position and UTC time.

- Press [◀]/[▶] to select desired number.
- Press [OK] to confirm.
- Move the cursor to select "←" or "→". Then press [OK].
- Select N (North Latitude) or S (South Latitude) when the cursor is on the "N" or "S" position.
- Select W (West Longitude) or E (East Longitude) when the cursor is on the "W" or "E" position.



## ◆ Cancel Distress Call

The nature of distress call should be included in distress call.

1. Press [CANCEL] while waiting for an acknowledgement call.



2. Press [CONTINUE]. The radio return to wait for an acknowledgement call if press [BACK].



3. Press [FINISH]. The radio return to wait for an acknowledgement call if press [BACK].

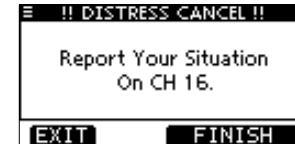

4. Transmit distress call.

5. Select Channel 16 automatically.

- Press [PTT] to report your situation.
- Press [EXIT] to return to normal operating mode after reporting.

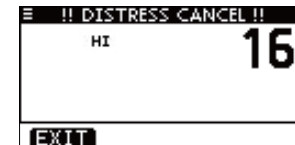

## ◆ Receive Distress Call

When a distress call is received,

→ The emergency alarm emits for 2 minutes.

→ "RCVD DISTRESS" appears and the backlight flashes.

1. Press [ALARM OFF] to stop alarm and backlight flash.



2. Press softkey to select desired operation.



※ Press [IGN] to ignore and return to normal operating mode.

- The radio exits DSC mode.
- The radio exits DSC mode while pressing [PTT].
- "✉" continues to flash and the call is stored in the received call record.

※ Press [INFO] to show the received call information.



※ Press [ACPT] to accept call. Then press [CH 16] to switch the operating channel to Channel 16 and monitor it as the major caller may require assistance. If you do not press [CH 16] in 10 seconds, the operating channel will switch to Channel 16 automatically.



## ◆ Receive Distress Acknowledgement

When a distress acknowledgement call is received from other ships,

→ The emergency alarm emits for 2 minutes.

→ "RCVD DISTRESS ACK" appears and the backlight flashes.

1. Press [ALARM OFF] to stop alarm and backlight flash.



2. Press softkey to select desired operation.



※ Press [IGN] to ignore and return to normal operating mode.

- The radio exits DSC mode.
- The radio exits DSC mode while pressing [PTT].
- "✉" continues to flash and the call is stored in the received call record.

※ Press [INFO] to show the received call information.

※ Press [ACPT] to accept call. Then press [CH 16] to switch the operating channel to Channel 16 and monitor it as the major caller may require assistance. If you do not press [CH 16] in 10 seconds, the operating channel will switch to Channel 16 automatically.

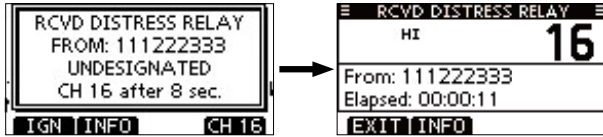

### ◆ Receive Distress Reply Call

- When a distress reply call is received,  
 → The emergency alarm emits for 2 minutes.  
 → "RCVD DISTRESS REPLY" appears and the backlight flashes.  
 1. Press [ALARM OFF] to stop alarm and backlight flash.



2. Press softkey to select desired operation.



- ※ Press [IGN] to ignore and return to normal operating mode.
  - The radio exits DSC mode.
  - The radio exits DSC mode while pressing [PTT].
  - "[ ]" continues to flash and the call is stored in the received call record.
- ※ Press [INFO] to show the received call information.
- ※ Press [ACPT] to accept call. Then press [CH 16] to switch the operating channel to Channel 16 and monitor it as the major caller may require assistance. If you do not press [CH 16] in 10 seconds, the operating channel will switch to Channel 16 automatically.

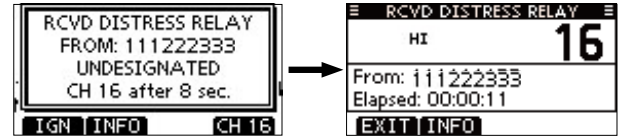

### ◆ Receive Distress Reply Acknowledgement

- When a distress reply acknowledgement is received,  
 → The emergency alarm emits for 2 minutes.  
 → "RCVD DIST REPLY ACK" appears and the backlight flashes.  
 1. Press [ALARM OFF] to stop alarm and backlight flash.



2. Press softkey to select desired operation.

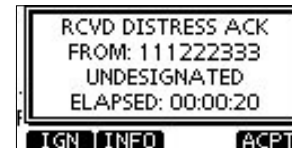

- ※ Press [IGN] to ignore and return to normal operating mode.
  - The radio exits DSC mode.
  - The radio exits DSC mode while pressing [PTT].
  - "[ ]" continues to flash and the call is stored in the received call record.
- ※ Press [INFO] to show the received call information.
- ※ Press [ACPT] to accept call. Then press [CH 16] to switch the operating channel to Channel 16 and monitor it as the major caller may require assistance. If you do not press [CH 16] in 10 seconds, the operating channel will switch to Channel 16 automatically.

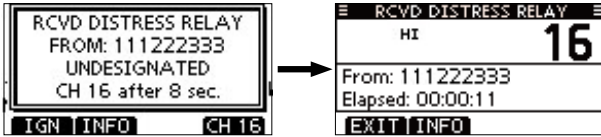

## Individual Call

The individual call function allows to call a specific ship.

### Transmit Individual Call

1. Enter "INDIVIDUAL CALL" in DSC CALLS menu.
2. Select the desired preprogrammed individual address or select "Manual Input" and then press [OK].
  - The individual ID code should be set first.
  - Set desired 9 digits MMSI code for individual call while selecting "Manual Input".

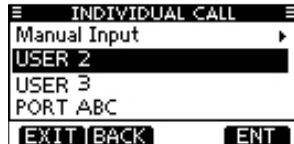

#### ※ Manual Input

Input the desired individual call ID as the following way.

- Press [▲]/[▼]/[◀]/[▶] to select desired number.
- Press [OK] to confirm.
- Move the cursor to select "←" or "→". Then press [OK].
- If the first digit is "0", it is regard as Group ID.
- If the first two digits is "00", it is regard as Coast Station ID.

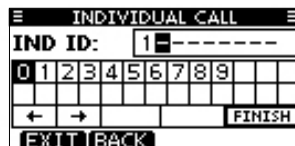

3. Select Routine, Safety or Urgency and then press [OK].

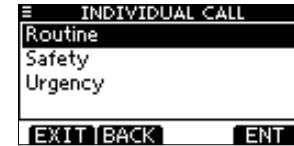

- NOTE: When a coast station is selected in Step 2. the voice channel will be specified by the coast station automatically. Therefore, skip Step 4 and go to Step 5 directly.

4. Select Routine, Safety or Urgency and then press [OK].

- Intership channels are already preset into the radio as the recommended order.



5. A confirmation interface appears to confirm the call contents.

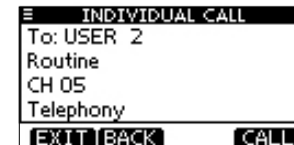

6. Press [CALL] to transmit individual call.

- If Channel 70 is busy, the radio will standby until channel leisure.

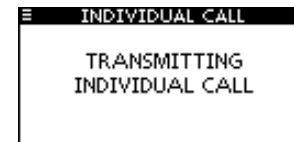

7. Standby in Channel 70 until an acknowledgement is received.
  - The radio waits in Channel 70 for 10 seconds and then alternately monitors Channel 70 and the operating channel.

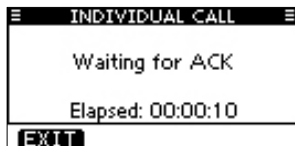

8. When the received acknowledgement is "Able to comply", a prompt sound emits and the screen is showed as below.



Press [ALARM OFF] to turn OFF the prompt sound. Follow Step 4 to select intership call channel.

- A different intership call channel will be selected if the station you call cannot use the channel.
- Press [PTT] to reply.

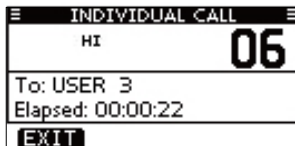

※ When the received acknowledgement is "Unable to comply", a prompt sound emits and the screen is showed as below.

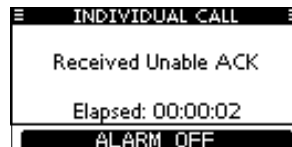

Press [ALARM OFF] to turn OFF the prompt sound. Then press [EXIT] to return to operating channel.

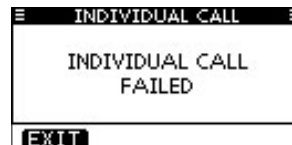

9. Press [EXIT] to return to normal operating mode.

### ◆ Receive Individual Call

While receiving individual call:

- The emergency alarm emits for 2 minutes.
  - "RCVD INDIVIDUAL" appears. The backlight may flash for 2 minutes according to the received category.
1. Press [ALARM OFF] to stop alarm and backlight flash.
    - The next interface will appears according to received category if no press [ALARM OFF] in 2 minutes.

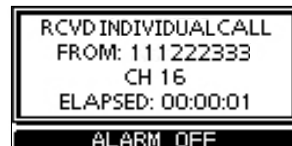

2. Press softkey to select desired operation.



- ※ Press [IGN] to ignore and return to normal operating mode.
  - The radio exits DSC mode.
  - "☑" continues to flash and the call is stored in the received call record.
- ※ Press [INFO] to show the received call information.
- ※ Press [ACK] to show "INDIVIDUAL ACK" reply call. Select the channel specified by major caller to communicate. While "INDIVIDUAL ACK" is set as "Auto ACK (Unable)", the radio will reply a call automatically. The transmit and receive call will be stored in Call Logs in this situation.

### ◆ Transmit Individual Acknowledgement

While receiving individual call, you can transmit an acknowledgement (Quick ACK) ("Able to Comply", "Propose New Channel" or "Unable to comply") by using screen prompts. You can also send an acknowledgement through the following menu operation. (Manual ACK)

#### Quick ACK

1. While receiving individual call, a prompt sound emits and the screen is showed as below.
  - Press [ALARM OFF] to turn OFF the prompt sound.



2. Press the softkey [ACK].

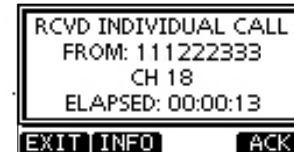

3. Select one of the options and then press [OK].

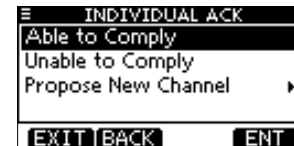

- Able to Comply: Transmit an acknowledgement without any changes.
- Unable to Comply: Cannot make a communication. The acknowledgement call (Unable to Comply) will transmit automatically.
- Propose New Channel: You can make an acknowledgement call, but it has specified intership communication channel. Press [▲]/[▼] to select desire intership communication channel and then press [OK].



4. The screen shows the ACK confirmation interface. Press [CALL] to transmit acknowledgement call.

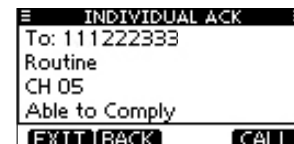

5. The screen is shown as below.

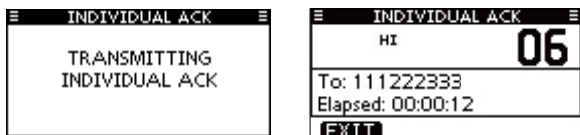

6. Press [PTT] to reply.
7. Press [EXIT] to return to normal operating mode.

### Manual ACK

1. Enter the "Individual ACK" in DSC CALLS menu.
  - The "Individual ACK" will not be shown if no individual call is received.



2. Press [▲]/[▼] to select individual address or ID code to reply and then press [OK].

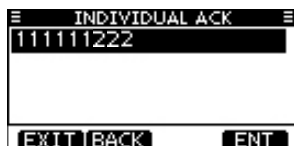

3. Follow Step 3 to Step 7 as describe in "Quick ACK".

## ■ Group Call

The group call function allows to call a specific ship station (ship group). The ship has its own group call ID code. The whole ship will receive while transmitting a group call.

### ◆ Transmit Group Call

1. Enter "GROUP CALL" in DSC CALLS menu.
2. Press [▲]/[▼] to select the desired preprogrammed group address or select "Manual Input" and then press [OK].
  - The group ID code should be set first.
  - Set 8 digits ID code for group code while selecting "Manual Input".

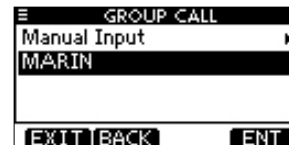

- ※ Manual Input
  - Input the desired group call ID as the following ways.
    - Press [▲]/[▼]/[◀]/[▶] to select desired number.
    - Press [OK] to confirm.
    - Move the cursor to select "←" or "→". Then press [OK].
    - If the first digit is "0", it is regard as Group ID.
    - If the first two digits is "00", it is regard as Coast Station ID.



3. Press [▲]/[▼] to select desire intership communication channel and then press [OK].
  - Intership channels are already preset into the radio as the recommended order.



4. A confirmation interface appears to confirm the call contents.



5. Press [CALL] to transmit group call.
- If Channel 70 is busy, the radio will standby until channel leisure.
6. The screen is shown as below after a group call is transmitted.

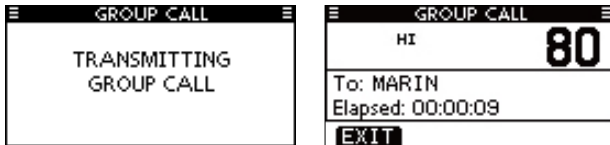

7. Press and hold [PTT] to communicate with specified ship.  
 8. Press [EXIT] to return to normal operating mode after the communication.

### ◆ Receive Group Call

- The emergency alarm emits for 2 minutes.
  - "RCVD GROUP CALL" appears. The backlight may flash for 2 minutes according to the received category.
1. Press [ALARM OFF] to stop alarm and backlight flash.
- The next interface will appear according to received category if no press [ALARM OFF] in 2 minutes.



2. Press softkey to select desired operation.



- ※ Press [IGN] to ignore and return to normal operating mode.
  - The radio exits DSC mode.
  - "☑" continues to flash and the call is stored in the received call record.
- ※ Press [INFO] to show the received call information.
- ※ Press [ACPT] to monitor the announcement by the major caller in the specified channel.

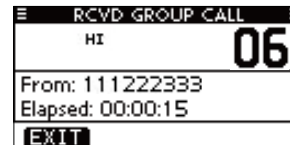

### ■ All Ships Call

The all ships call function allows to call the whole ships.

#### ◆ Transmit All Ships Call

1. Enter "ALL SHIPS CALL" in DSC CALLS menu.
2. Press [▲]/[▼] to select the desired preprogrammed group address or select "Manual Input" and then press [OK].
  - The selectable category may be different according to programmed setting. Please ask your dealer for the selectable category.



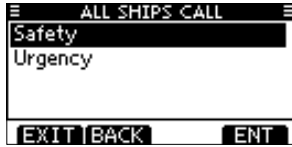

3. Press [▲]/[▼] to select desired communication channel and then press [OK].
  - The screen shows the selectable communication channels.



4. A confirmation interface appears to confirm the call contents.

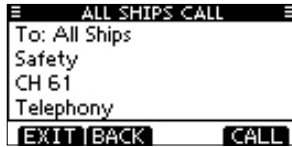

5. Press [CALL] to transmit all ships call.
  - If Channel 70 is busy, the radio will standby until channel leisure.

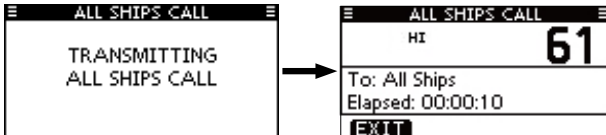

6. Press and hold [PTT] to communicate with specified ship.
7. Press [EXIT] to return to normal operating mode after the communication.

## ◆ Receive All Ships Call

While receiving all ships call:

- The emergency alarm emits for 2 minutes.
  - "RCVD ALL SHIPS CALL" appears. The backlight may flash for 2 minutes according to the received category.
1. Press [ALARM OFF] to stop alarm and backlight flash.
    - The next interface will appear according to received category if no press [ALARM OFF] in 2 minutes.



2. Press softkey to select desired operation.



- ※ Press [IGN] to ignore and return to normal operating mode.
  - The radio exits DSC mode.
  - "☐" continues to flash and the call is stored in the received call record.
- ※ Press [INFO] to show the received call information.
- ※ Press [ACPT] to show "POSITION REPLY" and send reply call.

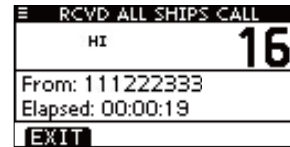

## ■ Geographical Area Call

The geographical area call function allows to call the whole ship stations in the sea area you are in.

### ◆ Receive Geographical Area Call

While receiving geographical area call:

- The emergency alarm emits for 2 minutes.
  - "RCVD GEOGRAPHICAL AREA CALL" appears. The backlight may flash for 2 minutes according to the received category.
1. Press [ALARM OFF] to stop alarm and backlight flash.
    - The next interface will appear according to received category if no press [ALARM OFF] in 2 minutes.



2. Press softkey to select desired operation.



- ※ Press [IGN] to ignore and return to normal operating mode.
  - The radio exits DSC mode.
  - "✉" continues to flash and the call is stored in the received call record.
- ※ Press [INFO] to show the received call information.
- ※ Press [ACPT] to monitor the announcement by the major caller in the specified channel.
  - When no GPS data is received or if there is problem with the connected GPS receiver, all geographical area call can be received no matter what position you are.

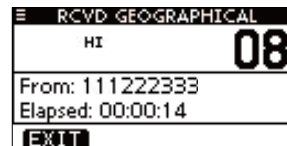

## ■ Position Request Call

Transmit a position request call while you want to know a specific ship's position.

### ◆ Transmit Position Request Call

Enter "POSITION REQUEST" in DSC CALLS menu.

1. Press [▲]/[▼] to select the desired preprogrammed individual address or select "Manual Input" and then press [OK].
  - The position request call ID code should be set first.
  - Set desired 9 digits MMSI code for individual code while selecting "Manual Input".

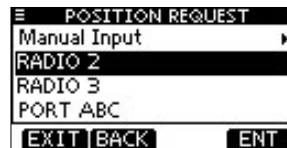

### ※ Manual Input

Input the desired individual call ID as the following ways.

- Press [▲]/[▼]/[◀]/[▶] to select desired number.
- Press [OK] to confirm.
- Move the cursor to select "←" or "→". Then press [OK].
- If the first digit is "0", it is regard as Group ID.
- If the first two digits is "00", it is regard as Coast Station ID.

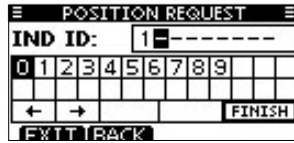

2. A confirmation interface appears to confirm the call contents.



3. Press [CALL] to transmit position request call.  
 • If Channel 70 is busy, the radio will standby until channel leisure.



4. The screen is shown as below after the position request call is transmitted.  
 • The radio waits in Channel 70 for 10 seconds and then alternately monitors Channel 70 and the operating channel.

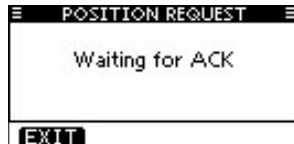

5. When the acknowledgement call is received, a prompt sound emits and the screen is shown as below.  
 6. Press [ALARM OFF] to turn OFF the prompt sound. The screen is shown as below.

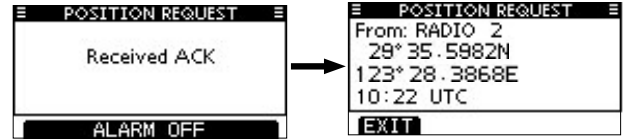

7. Press [EXIT] to return to normal operating mode.

### ◆ Receive Position Request Call

While receiving position request call:

- The emergency alarm emits for 2 minutes.
  - "RCVD POS REQUEST" appears. The backlight may flash for 2 minutes according to the received category.
1. Press [ALARM OFF] to stop alarm and backlight flash.
- The next interface will appear according to received category if no press [ALARM OFF] in 2 minutes.



2. Press softkey to select desired operation.



- ※ Press [IGN] to ignore and return to normal operating mode.
  - The radio exits DSC mode.
  - "☑" continues to flash and the call is stored in the received call record.
- ※ Press [INFO] to show the received call information.

- ※ Press [ACPT] to show "POSITION REPLY" and send reply call.
  - When the "POSITION ACK" is set as "Auto TX", the radio will reply call automatically. In this situation, the transmit and receive call will be stored in call record.



### ◆ Transmit Position Reply Call

The radio will transmit a position reply call while a position request call is received. When the "POSITION ACK" in DSC Settings is set as "Auto TX", the radio will transmit position reply call automatically after position request call is received.

#### Quick ACK

1. While receiving individual call, a prompt sound emits and the screen is showed as below.
  - Press [ALARM OFF] to turn OFF the prompt sound.



2. Press the softkey [ACK].



- Press [INFO] to show the received position request call information.
- Press [BACK] to return to last interface.

3. A position reply confirmation interface appears. Press [CALL] to transmit position reply call.
4. The screen shows as below after transmitting position reply call. Then return to normal operating mode.

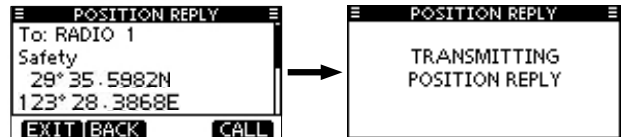

#### Manual Reply

1. Enter the "POSITION REPLY" in DSC CALLS menu.
  - The "POSITION REPLY" will not be shown if no position request call is received.



2. Press [▲]/[▼] to select desired position request call to reply and then press [OK].



3. The position reply call confirmation interface is shown as below.  
Press [CALL] to transmit position reply call.



4. The screen is shown as below after a position reply call is transmitted and then return to normal operating mode.



When no GPS data is received or invalid data is received, and both position and time are manually input, the screen is shown as below. Edit you latitude and longitude and UTC time as below.



※ Press [CHG] and edit the latitude and longitude position and UTC time.

- Press [◀]/[▶] to select desired number.
- Press [OK] to confirm.
- Move the cursor to select "←" or "→". Then press [OK].
- Select N (North Latitude) or S (South Latitude) when the cursor is on the "N" or "S" position.
- Select W (West Longitude) or E (East Longitude) when the cursor is on the "W" or "E" position

## ■ Position Report Call

Transmit a position report call while you want to know a specific ship's position.

### ◆ Transmit Position Report Call

1. Enter "POSITION REPORT" in DSC CALLS menu.
2. Press [▲]/[▼] to select the desired preprogrammed individual address or select "Manual Input" and then press [OK].
  - The individual call ID code should be set first.
  - Set desired 9 digits MMSI code for individual code while selecting "Manual Input".

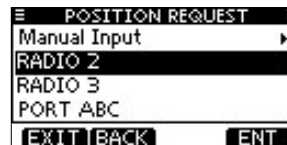

※ Manual Input

Input the desired individual call ID as the following way.

- Press [▲]/[▼]/[◀]/[▶] to select desired number.
- Press [OK] to confirm.
- Move the cursor to select "←" or "→". Then press [OK].
- If the first digit is "0", it is regard as Group ID.
- If the first two digits is "00", it is regard as Coast Station ID.

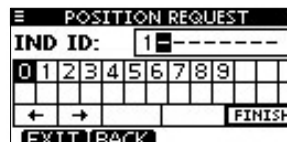

3. A confirmation interface appears to confirm the call contents.



4. Press [CALL] to transmit position request call.
- If Channel 70 is busy, the radio will standby until channel leisure.



5. The screen is shown as below after a position report call is transmitted and then return to normal operating mode.
- When no GPS data is received or invalid data is received, and both position and time are manually input, the screen is shown as below. Edit you latitude and longitude and UTC time as below.



- ※ Press [CHG] and edit the latitude and longitude position and UTC time.
  - Press [◀]/[▶] to select desired number.
  - Press [OK] to confirm.
  - Move the cursor to select "←" or "→". Then press [OK].
  - Select N (North Latitude) or S (South Latitude) when the cursor is on the "N" or "S" position.
  - Select W (West Longitude) or E (East Longitude) when the cursor is on the "W" or "E" position.

## ◆ Receive Position Report Call

While receiving position report call:

- The emergency alarm emits for 2 minutes.
  - "RCVD POSITION REPORT" appears. The backlight may flash for 2 minutes according to the received category.
1. Press [ALARM OFF] to stop alarm and backlight flash.
- The next interface will appear according to received category if no press [ALARM OFF] in 2 minutes.



2. Press softkey to select desired operation.



- ※ Press [EXIT] to ignore call and return to normal operating mode.
  - The radio exits DSC mode.
  - "☑" continues to flash and the call is stored in the received call record.
- ※ Press [INFO] to show the received call information.



## ◆ Transmit Position Report Reply Call

The radio will transmit a position report reply call while a position report call is received.

### Quick ACK

1. While receiving individual call, a prompt sound emits and the screen is showed as below. Press [ALARM OFF] to turn OFF the prompt sound.



2. Press the softkey [ACK].



- Press [INFO] to show the received position request call information.
- Press [BACK] to return to last interface.

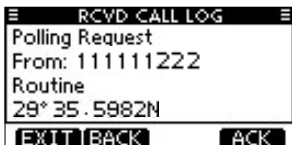

3. A position report reply confirmation interface appears. Press [CALL] to transmit reply call.
4. The screen shows as below after transmitting position reply call. Then return to normal operating mode.

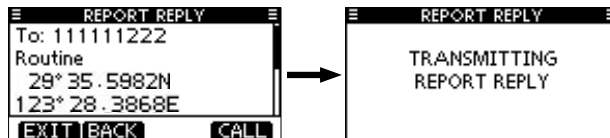

### Manual Reply

1. Enter the "POSITION REPORT REPLY" in DSC CALLS menu.
  - The "POSITION REPORT REPLY" will not be shown if no position request call is received.



2. Press [▲]/[▼] to select desired position report call to reply and then press [OK].

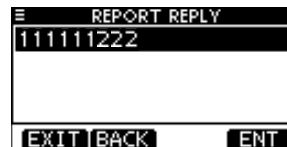

3. The position report reply call confirmation interface is shown as below. Press [CALL] to transmit position reply call.
4. The screen is shown as below after a position report reply call is transmitted and then return to normal operating mode.

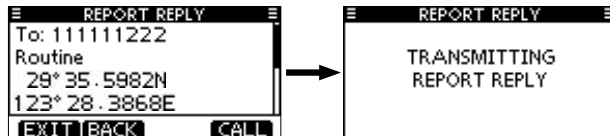

## ■ Polling Request Call

Transmit a polling report call while you want to know if a specific ship is in the communication area or not.

### ◆ Transmit Polling Request Call

1. Enter "POLLING REQUEST" in DSC CALLS menu.
2. Press [▲]/[▼] to select the desired preprogrammed individual address or select "Manual Input" and then press [OK].
  - The individual call ID code should be set first.
  - Set desired 9 digits MMSI code for individual code while selecting "Manual Input".

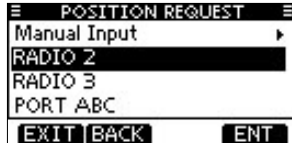

#### ※ Manual Input

Input the desired individual call ID as the following way.

- Press [◀]/[▶] to select desired number.
- Press [OK] to confirm.
- Move the cursor to select "←" or "→". Then press [OK].
- If the first digit is "0", it is regard as Group ID.
- If the first two digits is "00", it is regard as Coast Station ID.

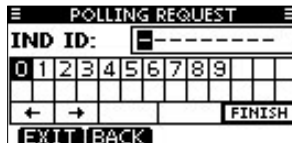

3. A confirmation interface appears to confirm the call contents.

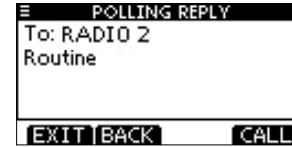

4. Press [CALL] to transmit polling request call.
  - If Channel 70 is busy, the radio will standby until channel leisure.



5. The screen is shown as below after a polling request call is transmitted.
  - The radio waits in Channel 70 for 10 seconds and then alternately monitors Channel 70 and the operating channel.

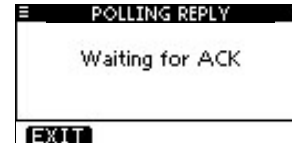

6. When the acknowledgement call is received, a prompt sound emits and the screen is showed as below.





- Press [ALARM OFF] to turn OFF the prompt sound. The screen is shown as below.

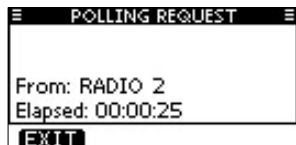

- Press [BACK] to return to normal operating mode.

### ◆ Receive Polling Request Call

While receiving polling request call:

- The emergency alarm emits for 2 minutes.
- "RCVD POLLING REQUEST" appears. The backlight may flash for 2 minutes according to the received category.

- Press [ALARM OFF] to stop alarm and backlight flash.
  - The next interface will appear according to received category if no press [ALARM OFF] in 2 minutes.

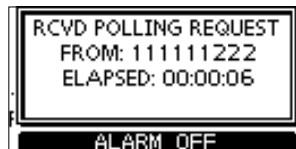

- Press softkey to select desired operation.

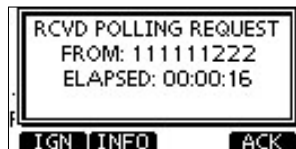

- ※ Press [IGN] to ignore and return to normal operating mode.
  - The radio exits DSC mode.
  - "✉" continues to flash and the call is stored in the received call record.
- ※ Press [INFO] to show the received call information.
- ※ Press [ACK] to show "POLLING REPLY" and send reply call.
  - When the "POSITION ACK" is set as "Auto TX", the radio will reply call automatically. In this situation, the transmit and receive call will be stored in call record.

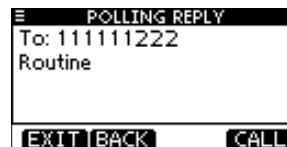

### ◆ Transmit Polling Reply Call

The radio will transmit a polling reply call while a polling request reply call is received. When the "POSITION ACK" in DSC Settings is set as "Auto TX", the radio will transmit polling reply call automatically after polling request call is received.

#### Quick ACK

- While receiving polling request call, a prompt sound emits and the screen is showed as below.
  - Press [ALARM OFF] to turn OFF the prompt sound.



2. Press the softkey [ACK].



- Press [INFO] to show the received polling request call information.
- Press [BACK] to return to last interface.



3. A polling reply confirmation interface appear. Press [CALL] to transmit polling reply call.

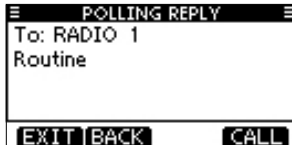

4. The screen shows as below after transmitting polling reply call. Then return to normal operating mode.



## Manual Reply

1. Enter the "POLLING REPLY" in DSC CALLS menu.
  - The "POLLING REPLY" will not be shown if no polling request call is received.

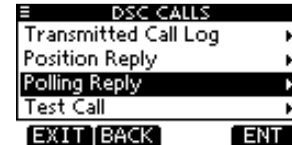

2. Press [▲]/[▼] to select desired polling request call to reply and then press [OK].

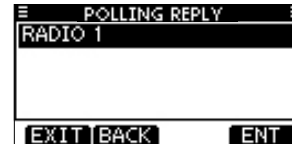

3. The polling reply call confirmation interface is shown as below. Press [CALL] to transmit polling reply call.

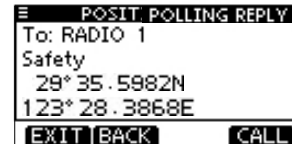

4. The screen is shown as below after a polling reply call is transmitted and then return to normal operating mode.

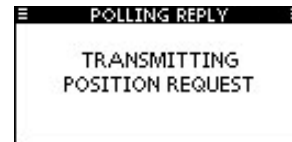

## ■ Test Call

Avoid testing in the exclusive DSC distress and safety calling channels. If testing in the distress/safety channel, you should indicate these calls are for testing. Normally, the test call no need further communications between the two stations.

### ◆ Transmit Test Call

1. Enter "TEST CALL" in DSC CALLS menu.
2. Press [▲]/[▼] to select the desired preprogrammed individual address or select "Manual Input" and then press [OK].
  - The individual call ID code should be set first.
  - Set desired 9 digits MMSI code for individual code while selecting "Manual Input".

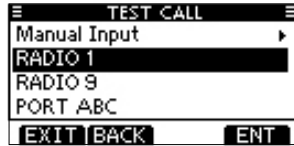

### ※ Manual Input

Input the desired individual call ID as the following ways.

- Press [◀]/[▶] to select desired number.
- Press [OK] to confirm.
- Move the cursor to select "←" or "→". Then press [OK].
- If the first digit is "0", it is regard as Group ID.
- If the first two digits is "0", it is regard as Coast Station ID.



3. A confirmation interface appears to confirm the call contents.



4. Press [CALL] to transmit test call.
  - If Channel 70 is busy, the radio will standby until channel leisure.

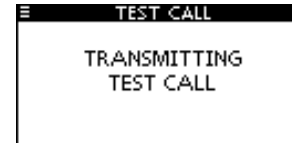

5. The screen is shown as below after a test call is transmitted.
  - The radio waits in Channel 70 for 10 seconds and then alternately monitors Channel 70 and the operating channel.

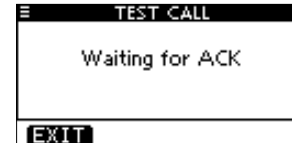

6. When the acknowledgement call is received, a prompt sound emits and the screen is showed as below.



- Press [ALARM OFF] to turn OFF the prompt sound. The screen is shown as below.



- Press [BACK] to return to normal operating mode.

### ◆ Receive Test Call

While receiving test call:

- The emergency alarm emits for 2 minutes.
- "RCVD TEST CALL" appears. The backlight may flash for 2 minutes according to the received category.

- Press [ALARM OFF] to stop alarm and backlight flash.
  - The next interface will appear according to received category if no press [ALARM OFF] in 2 minutes.



- Press softkey to select desired operation.

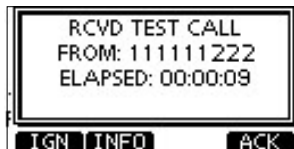

- ※ Press [IGN] to ignore and return to normal operating mode.
  - The radio exits DSC mode.
  - "✉" continues to flash and the call is stored in the received call record.
- ※ Press [INFO] to show the received call information.
- ※ Press [ACK] to show "TEST ACK" and send reply call.
  - When the "TEST ACK" is set as "Auto TX", the radio will reply call automatically. In this situation, the transmit and receive call will be stored in call record.

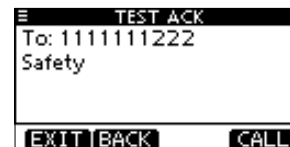

### ◆ Transmit Test Acknowledgement Call

When the "TEST ACK" in DSC Settings is set as "Auto TX", the radio will transmit test reply call automatically after test call is received.

#### Quick ACK

- While receiving test call, a prompt sound emits and the screen is showed as below.
  - Press [ALARM OFF] to turn OFF the prompt sound.



- Press the softkey [ACK].



- Press [INFO] to show the received test call information.
- Press [BACK] to return to last interface.



3. A test ACK confirmation interface appears. Press [CALL] to transmit test acknowledgement call.



4. The screen shows as below after transmitting test acknowledgement call. Then return to normal operating mode.



### Manual Reply

1. Enter the "TEST ACK" in DSC CALLS menu.
  - The "TEST ACK" will not be shown if no test call is received.



2. Press [▲]/[▼] to select desired test call to reply and then press [OK].

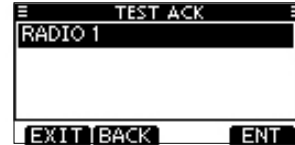

3. The test ACK confirmation interface is shown as below. Press [CALL] to transmit test acknowledgement call.



4. The screen is shown as below after a test acknowledgement call is transmitted and then return to normal operating mode.



### ◆ Receive Test Acknowledgement Call

While receiving test acknowledgement call:

- The emergency alarm emits for 2 minutes.
- "RCVD TEST ACK" appears. The backlight may flash for 2 minutes.

1. Press [ALARM OFF] to stop alarm and backlight flash.
  - The next interface will appear according to received category if no press [ALARM OFF] in 2 minutes.



2. Press softkey to select desired operation.

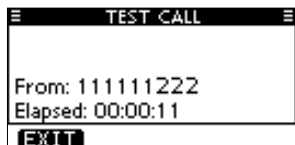

- ※ Press [EXIT] to return to normal operating mode.
  - The radio exits DSC mode.
  - "✉" continues to flash and the call is stored in the received call record.

## ■ Received Call Log

The radio can store up to 50 distress messages and 50 other messages. They can be used as supplement. In normal operating mode, if there are unread messages, "✉" flashes on the screen right side.

### ◆ Distress Message

1. Press [LOG] to enter "RCVD CALL LOG" in DSC CALLS menu.
2. Press [▲]/[▼] to select "DISTRESS" and then press [OK].
  - The distress messages are stored in "Distress".
  - "✉" appears if there are unread messages.
  - "🗑️" appears if there are no unread messages.
  - Nothing appears if there are no messages.



3. Press [▲]/[▼] to select desired item and then press [OK].
  - The message in the unopened file has not been read.

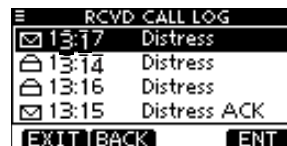

4. Press [▲]/[▼] to scroll the message contents.
  - Press [WP] to store received position.

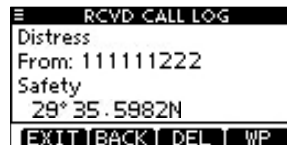

5. Press [DEL] to delete displayed information.
  - The confirmation screen appears and then press [OK] to delete.
6. Press [EXIT] to return to the normal operating mode.

### ◆ Other Messages

1. Press [LOG] to enter "RCVD CALL LOG" in DSC CALLS menu.
2. Press [▲]/[▼] to select "Others" and then press [OK].
  - The messages except distress are stored in "Other".
  - "✉" appears if there are unread messages.
  - "🗑️" appears if there are no unread messages.
  - Nothing appears if there are no messages.

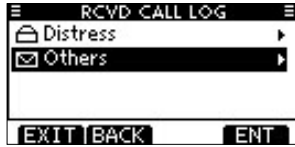

3. Press [▲]/[▼] to select desired item and then press [OK].
  - The message in the unopened file has not been read.

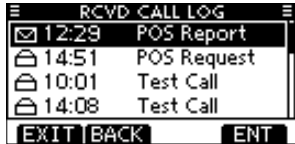

4. Press [▲]/[▼] to scroll the message contents.
  - The stored message has various information, depending on the DSC call type.
  - Press [WP] to store received position.



5. Press [DEL] to delete displayed information.
  - The confirmation screen appears and then press [OK] to delete.
6. Press [EXIT] to return to the normal operating mode.

## ■ Transmitted Call Log

The radio can store up to 50 transmitted calls and they can be used as log supplement.

1. Enter "RX CALL LOG" in DSC CALLS menu.
2. Press [▲]/[▼] to select desired item and then press [OK].

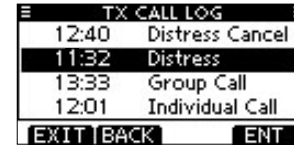

3. Press [▲]/[▼] to scroll the message contents.



4. Press [DEL] to delete displayed information.
  - The confirmation screen appears and then press [OK] to delete.
5. Press [EXIT] to return to the normal operating mode.

## OTHER FUNCTIONS

### ■ MOB (Man OverBoard)

The radio can register an MOB (Man OverBoard) point with its position data while a person has fallen into water and need rescue.

#### ◆ Store a MOB point

1. Press [MOB] for 1 second to store MOB point.
  - Two prompt sound emits.
  - "MAN OVERBOARD" appears after memorizing MOB point.
  - The MOB point cannot be stored if the GPS receiver has not yet calculated the position.
  - Only one MOB point can be memorized. The previous stored point will be overwritten while a new MOB point is stored.

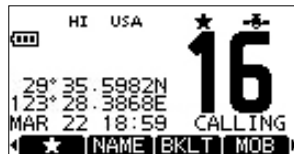

2. After the information screen appears, press [ENT] to open the MOB interface and then the navigation will start from stored point.
  - If no key operation is performed in 10 seconds, the radio will return to last interface; Or press any key to return manually.



3. Press [EXIT] to exit the navigation screen and return to the normal operating mode.

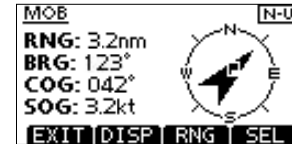

#### ◆ Check the Stored MOB point

1. Press [MENU] to enter menu interface.
2. Press [◀]/[▶] to select "MOB" and enter MOB interface.
  - MOB interface appears.
  - Press [MOB] also opens the interface.
  - A blank screen appears if the MOB point has not been stored or has been deleted.



3. Press softkey to select desired operation.

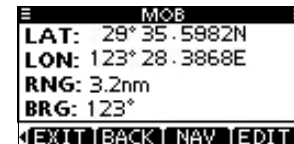

- Press [EXIT] to return to normal operating mode.
- Press [BACK] to return to menu interface.

#### ◆ Start Navigation to MOB point

- Press [NAV] to navigate to MOB point.



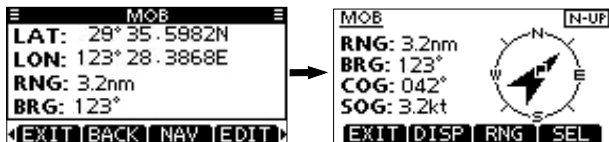

### ◆ Edit MOB point

Press [EDIT] to change the stored MOB position.

1. Press [EDIT] to enter position data editing interface.
2. Edit specified latitude and longitude data as the following ways.
  - Press [▲]/[▼]/[◀]/[▶] to select desired number.
  - Press [OK] to set digit.
  - Select N (North Latitude) or S (South Latitude) when the cursor is on the "N" or "S" position.
  - Select W (West Longitude) or E (East Longitude) when the cursor is on the "W" or "E" position.
  - Move the cursor to select "←" or "→". Then press [OK].
  - Select "FINISH" to set interface data and then press [OK].



3. Press [OK] to save position data after the confirmation interface appears and return to the MOB interface.

### ◆ Delete MOB point

Press [DEL] to delete the stored MOB position.

NOTE: A deleted MOB point cannot be restored.

1. Press [DEL] to delete MOB point.
  - "ARE YOU SURE?" appears in the confirmation interface.
2. Edit specified latitude and longitude data as the following way.
  - Press [OK] to delete data and return to MOB interface.

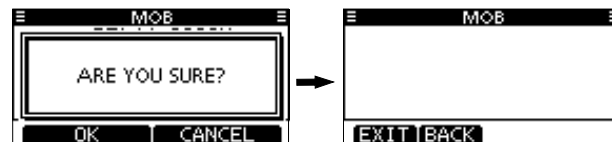

- A blank screen appears.
- Press [EXIT] to return to normal operation mode.
- Press [BACK] to return to menu interface.

## ■ Waypoint

The radio can store vessel's position at any time and also regard the received DSC call of vessel position information as a waypoint. The radio can store up to 50 waypoints. Each waypoint can be named by alphabet or numbers for easy recognition. The name can be maximum 10 characters.

### ◆ Store Position

- Press [WP] for 1 second to store waypoint.
- Two prompt sound emits.
- "WAYPOINT WAS STORED" appears after memorizing waypoint.
- The waypoint cannot be stored if the GPS receiver has not yet calculated the position.
- The new waypoint cannot be stored if already store 50 waypoints.



### ◆ Store Received Position

Register the received DSC call position as a waypoint.

1. Enter "RCVD CALL LOG" in DSC CALLS menu.

- Press [LOG] also to enter this interface.
2. Press [▲]/[▼] to select "Distress" or "Others" and then press [OK].
  3. Press [▲]/[▼] to select desired item and then press [OK].
  4. Press [WP] to store and "STORE WAYPOINT?" appears.



5. Press [OK] to register the received position as a waypoint.
  - The new waypoint cannot be stored if already store 50 waypoints.
  - The stored received position information include MMSI ID code and waypoint name. If the ID code has been programmed in individual address, the position name will replace the ID code.

### ◆ Check the Stored Waypoint

1. Press [MENU] to enter menu interface.
2. Press [▲]/[▼] to select "Waypoint" and enter waypoint list interface.
  - Press [WP] also enters the waypoint list interface.



3. Press [▲]/[▼] to select desired waypoint and then press [OK] to open waypoint interface. Or press softkey to select the desired operation in the waypoint interface.

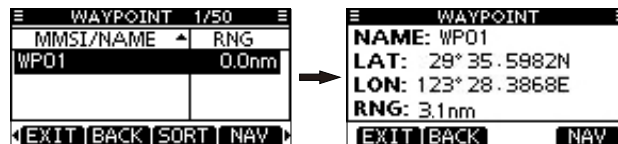

### ◆ Sort the Waypoint

- Press [SORT]. The radio can sort the waypoints in the waypoint list. Press [SORT] one time or more times to sort your desired waypoint order.



### ◆ Navigation to Waypoint

- Press [NAV] to start navigation to waypoint.



### ◆ Add Waypoint

Press [ADD] to program the name and position data of the new waypoints manually.

1. Press [ADD] to enter the name programming interface. "WP01" appears as a default name.



2. Input desired 10 digits ID as the following ways.

- Press [▲]/[▼]/[◀]/[▶] to select desired character.
- Press [OK] to confirm.
- Move the cursor, select "←" or "→". Then press [OK].
- Press [123]/[!\$?]/[ABC] to select character group.

3. After inputting name, press [▲]/[▼]/[◀]/[▶] to select "FINISH". Press [OK] to confirm and enter position data programming interface.

- The current position data appears on screen as the default.
- Press [▲]/[▼]/[◀]/[▶] to select desired number.
- Select N (North Latitude) or S (South Latitude) when the cursor is on the "N" or "S" position.
- Select W (West Longitude) or E (East Longitude) when the cursor is on the "W" or "E" position.
- Move the cursor to select "←" or "→". Then press [OK].
- Select "FINISH" to set interface data and then press [OK].

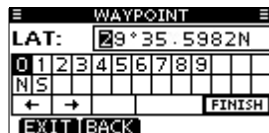
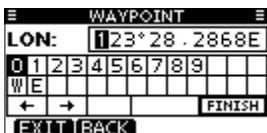

4. Press [OK] to save waypoint after the confirmation interface appears and return to the waypoint list interface.

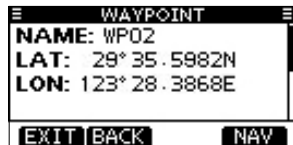

### ◆ Edit Waypoint

Press [EDIT] to change the stored waypoint name and position data.

1. Press [EDIT] to enter name programming interface. The preprogrammed name appears.



2. Edit the latitude and longitude data as the following way.

- The preprogrammed position data appears.
- Press [▲]/[▼]/[◀]/[▶] to select desired number.
- Press [OK] to confirm digit setting.
- Select N (North Latitude) or S (South Latitude) when the cursor is on the "N" or "S" position.
- Select W (West Longitude) or E (East Longitude) when the cursor is on the "W" or "E" position.
- Move the cursor to select "←" or "→". Then press [OK].
- Select "FINISH" to set interface data and then press [OK].

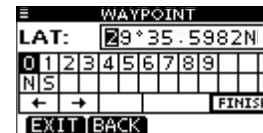
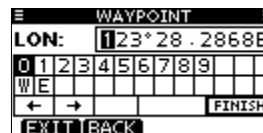

4. Press [OK] to save waypoint after the confirmation interface appears and return to the waypoint list interface.

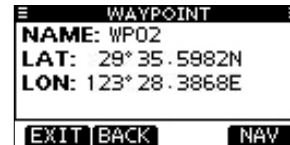

### ◆ Delete Waypoint

Press [DEL] to delete the stored waypoint.

NOTE: A deleted waypoint cannot be restored.

1. Press [DEL] to delete waypoint.

- "ARE YOU SURE?" appears in the confirmation interface.



- Press [OK] to delete data and return to waypoint list interface.

## Navigation

The navigation function can navigate from your current position to the specified waypoint (including MOB point).

NOTE: The MOB point or waypoint has been registered first.

### Navigation to MOB Point

- Press [MENU] to enter menu interface.
- Press [▲]/[▼] to select "MOB" and enter MOB interface.
  - Press [MOB] also enters the MOB interface.
- Press [NAV] to start navigation to MOB point.

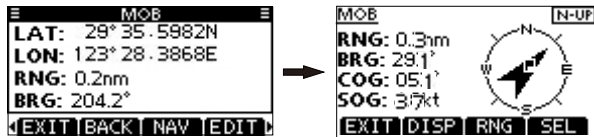

### Navigation to Waypoint

- Press [MENU] to enter menu interface.
- Press [▲]/[▼] to select "Waypoint" and enter waypoint list interface.
  - Press [WP] also enters the waypoint list interface.
- Press [▲]/[▼] to select desired waypoint and then press [NAV] to start navigation to waypoint.

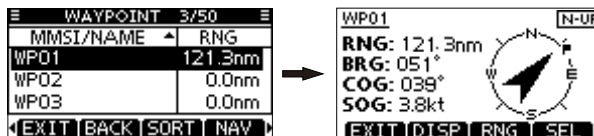

### Navigation Interface Description

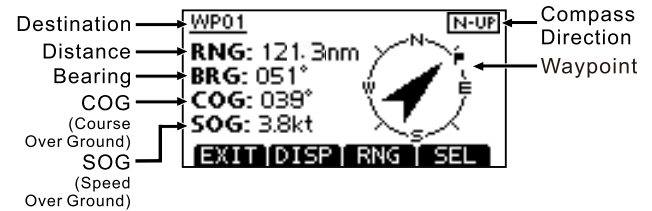

- Press [DISP] to switch display type. Two display types are selectable.

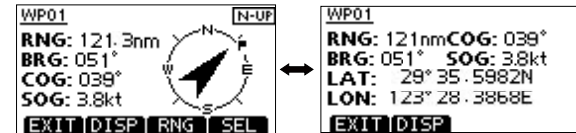

- Press [RNG] to open the range setting window, then press [▲]/[▼]/[◀]/[▶] to select desired range. Eight ranges are selectable. The range shows the radius of the compass circle.

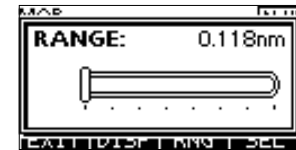

- Press [SEL] to select compass direction, N-UP, W-UP and AC-UP.
  - N-UP: The compass is always north.
  - W-UP: The compass is always the waypoint (destination).
  - AC-UP: The compass is always pointed to heading direction.
- Press [EXIT] to return to normal operating mode.

## MENU INTERFACE OPERATION

### ■ Menu Interface Operation

The menu interface is used for programming infrequently changed values, function settings or sending DSC call.



#### ◆ Enter Menu Interface Operation

1. Press [MENU] to enter menu interface.
2. Press [▲]/[▼] to select desired menu item and then press [OK] to confirm or enter the next level menu.
  - Repeat this operation to enter each menu item.
3. Press [CLEAR] or [BACK] to return to last level menu.
4. Press [EXIT] to exit menu interface.

### ■ Menu Items

The menu screen contains the following items.

Main	Item	Ref.
DSC Call	Individual Call	22
	Individual ACK(NOTE 1)	24
	Group Call	25
	All Ships Call	26
	Distress Call	17
	Received Call Log	40
	Transmitted Call Log	41
	Position Request	28
	Position Report	31
	Polling Request	34
	Test Call	37
DSC Setting	Test ACK(NOTE 1)	38
	Position Input(NOTE 2)	13
	Individual ID	14、 15
	Group ID	14、 15
	Individual ACK	15、 16
	Position ACK	15、 16

## ■ Compass Interface

The compass interface shows the vessel's COG (Course Over Ground) and SOG (Speed Over Ground).

1. Press [COMP]. The screen is shown as below.

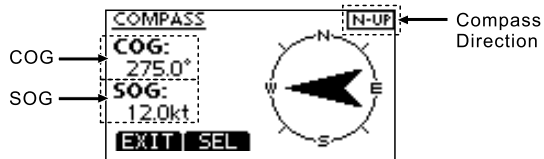

2. Press [SEL] to select compass direction, N-UP or AC-UP.
  - N-UP: The compass is always north.
  - AC-UP: The compass is always pointed to heading direction.
3. Press [EXIT] to return to normal operating mode.

## ■ GPS Status Interface

The GPS status interface shows the quantity, signal strength and position of the GPS satellites. The screen also shows the direction, elevation angle, satellite numbers and satellite signal strength.

1. Press [MENU] to enter menu interface.
2. Press [▲]/[▼] to select "GPS Status" and then press [OK] to show the sky view screen.

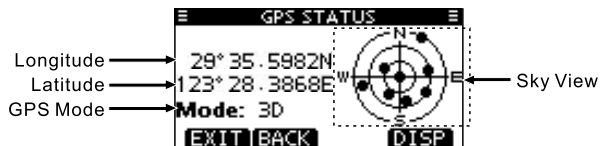

- Press [DISP] to switch between sky view and satellite signal.
- Press [BACK] to return to menu screen.
- Press [EXIT] to return to normal operating mode.

NOTE: "3D" appears while receiving more than 4 satellite signals. "2D" appears while receiving less than 3 satellites.

### ◆ Sky View

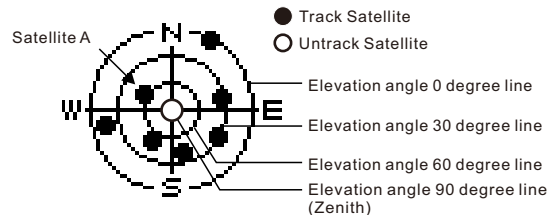

### ◆ Satellite Image

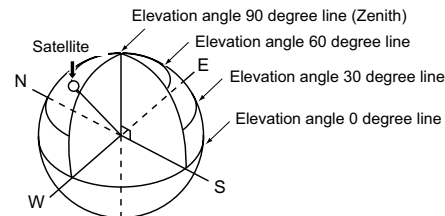

### ◆ Satellite Signal Strength Interface Description

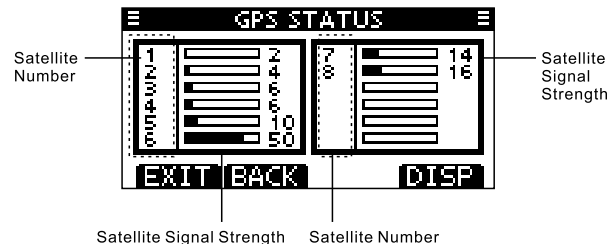

Main	Item	Ref.
DSC Setting	Test ACK	15, 16
	CH 16 Switch	16
	Alarm	16
	CH 70 SQL Level	16
	DSC Loop Test	17
	CH 70 Watch	17
Radio Setting	Scan Type	50
	Scan Timer	50
	Dual/Tri-Watch	50
	Channel Group	50
	WX Alert	50
Configuration	Backlight	51
	Display Contrast	51
	Key Beep	51
	Key Assignment	51
	UTC Offset	51
	Noise Cancel	51
	Inactivity Timer	51
	Float 'n Flash	51
	Monitor	51
Unit	51	

Main	Item	Ref.
MMSI/GPS Information	MMSI\LAT\LON\UTC\ SOG\COG\SW Ver	13
MOB	LAT\LON\RNG\BRG\ COG\SOG	42
Waypoint	NAME\LAT\LON\RNG\ BRG\COG\SOG	43
GPS Status	Sky view	47
	The image of the Satellite	47
	Satellite number\ signal power	47

NOTE 1: Appears only after receiving a call.

NOTE 2: "NO DSC MMSI" appears while MMSI code is not preset.

## ■ Set Items

S/N	Set Item	Set Item	Default
1	SCAN TYPE	Normal Scan Priority Scan	Normal Scan
2	SCAN TIMER	ON/OFF	OFF
3	DUAL/TRI-WATCH	Dualwatch Tri-watch	Dualwatch
4	CHAN GROUP	USA/INT/CAN	USA
5	WX ALERT	ON with Scan/ ON/OFF	OFF

## ◆ Scan Type

The radio has two scan types, normal scan and priority scan. The normal scan searches all TAG channels in selected channel group. The priority scan inserts scan Channel 16 during normal scan.

## ◆ Scan Timer

The scan timer can be selected as OFF or ON. While OFF is selected, the scan will pause until signal disappears. While ON is selected, the scan pause for 5 seconds and then resume, even if the signal is received on any channel other than Channel 16.

## ◆ Dual/Tri-Watch

This function can select dual watch or tri-watch.

## ◆ Channel Group

The channel group can be selected according to the operating area. USA, INT and CAN are selectable.

## ◆ Weather Alert

A NOAA broadcast station will transmit a weather alert sound while there is important weather information. While the weather alert function is ON, "WX" flashes and the alert sound emits after receiving the alert. The current weather channel will be scanned during the scanning. "WX" appears while this function is ON.

- ON with Scan: The preprogrammed weather channels are sequentially checked during scanning.
- ON: The previously used weather channel is checked during scanning.
- OFF: The radio does not check weather channel alert sound.

## ■ Configuration Items

Configuration Item		Configuration Selection	Default
BACKLIGHT		Level 7/OFF	Level 4
DISPLAY CONTRAST		Level 1-8	Level 3
KEY BEEP		ON/OFF	ON
KEY ASSIGNMENT		Softkey 1	SCAN
		Softkey 2	DW
		Softkey 3	HI/LO
		Softkey 4	CH/WX
UTC OFFSET		-14:00~+14:00	00:00
NOISE CANCEL	RX	OFF/1/2/3	OFF
	TX	OFF/1/2/3	OFF
INACTIVITY TIMER	Not DSC Related	1-10 Minutes	10 Minutes
	DSC Related	1-15 Minutes	15Minutes
FLOAT'N FLASH	Function	ON/OFF	ON
	Auto OFF	0-30 Seconds	20 Seconds
	Cycle	0.5\1\2\4 Seconds	0.5 Seconds
	Alarm	ON/OFF	OFF
Monitor		Push/Hold	Push
Unit		Nautical Mile /Kilo-Meter	Nautical Mile



## ◆ Backlight

This function is better for night operation. Press any key (except PTT) to activate while the backlight function is ON.  
The backlight can be set as 7 levels and OFF.

## ◆ Display Contrast

8 levels LCD display contrast are adjusted. Level 1 is the lowest and Level 8 is the highest.

## ◆ Key Beep

The key beep can be turn OFF to select silent operation or be turn ON.

## ◆ Key Assignment

The desired functions can be assigned to the softkeys.

1. Select "KEY ASSIGNMENT" in display interface. Press [▲]/[▼] to select desired setting softkey and then press [OK] to enter setting.
2. Press [▲]/[▼] to select desired function and then press [OK] to confirm setting.

## ◆ UTC Offset

The UTC offset can be adjusted between -14:00 and 14:00 in 1 minute step.

## ◆ Noise Cancel

Set the noise cancel function in both receive and transmit.

1. Select "NOISE CANCEL" in display interface. Press [▲]/[▼] to select RX or TX and then press [OK].
2. Press [▲]/[▼] to select the option and then press [OK] to confirm.
3. Press [EXIT] to exit the menu interface. Press [CLEAR] or [BACK] to return to last interface.
  - **RX:** Turn the Noise Cancel Function ON or OFF.
  - **TX:** Turn the transmit Noise Cancel Function ON or OFF.

## ◆ Inactivity Timer

There are two configuration items: (1) "Not DSC Related": Set the inactivity timer between 1 and 10 minutes or OFF. (2) "DSC Related": Set the inactivity timer between 1 and 15 minutes or OFF.

1. Select "INACTIVITY TIMER" in display interface. Press [▲]/[▼] to select "Not DSC Related" or "DSC Related" and then press [OK].
2. Press [▲]/[▼] to select option and then press [OK] to confirm.
3. Press [EXIT] to exit the menu interface. Press [CLEAR] or [BACK] to return to last interface.
  - Not DSC Related: When the current display screen is not related to DSC, if no key operation occurs, the radio will return to normal operating mode automatically.
  - DSC Related: When the current display screen is related to DSC, if no key operation occurs, except distress operation, the radio will return to normal operating mode automatically.

## ◆ Float & Flash

The Float & Flash function can detect the radio come in contact with water. When this function is activated, LCD and key backlight start to flash and an alarm sound emits. Make it easy to find the radio especially at night or in a dark environment.

- Function: Turn the Float & Flash Function ON or OFF.
- Auto OFF: Set the auto OFF time between 0 and 30 seconds after taking out of the water.
- Cycle: Select the LCD backlight cycle time between 0.5, 1, 2 and 4 seconds.
- Alarm: Select the alarm sounds.

## ◆ Monitor

The following two Monitor operations are selective.

- Push: Press [VOL/SQL] for 1 second, the squelch opens and emits sounds. The squelch keeps opened while holding down [VOL/SQL]. Release [VOL/SQL] to turn OFF.
- Hold: Press [VOL/SQL] for 1 second, the loudspeaker opens and emits sounds. The loudspeaker keeps opened while holding down [VOL/SQL]. Press any key to turn OFF.

## ◆ Unit

Select either Nautical Mile or Kilo Meter format to show the distance.

# VHF MARINE CHANNEL LIST

USA - USA Channel Group , INT - International Channel Group , CAN - Canadian Channel Group

Channel Number			Frequency (MHz)		Channel Number			Frequency (MHz)		Channel Number			Frequency (MHz)		Channel Number			Frequency (MHz)	
USA	INT	CAN	Transmit	Receive	USA	INT	CAN	Transmit	Receive	USA	INT	CAN	Transmit	Receive	USA	INT	CAN	Transmit	Receive
	01	01	156.050	160.650		21	21	157.050	161.650	68	68	68	156.425	156.425	86A			157.325	157.325
01A			156.050	156.050	21A		21A	157.050	157.050	69	69	69	156.475	156.475	87	87	87	157.375	161.975
	02	02	156.100	160.700			21b	RX Only	161.650	70	70	70	RX Only	156.525	87A			157.375	157.375
	03	03	156.150	160.750		22		157.100	161.700	71	71	71	156.575	156.575	88	88	88	157.425	162.025
03A			156.150	156.150	22A		22A	157.100	157.100	72	72	72	156.625	156.625	88A			157.425	157.425
	04		156.200	160.800		23	23	157.150	161.750	73	73	73	156.675	156.675		A1 <sup>2</sup>		161.975	161.975
		04A	156.200	156.200	23A			157.150	157.150	74	74	74	156.725	156.725		A2 <sup>2</sup>		162.025	162.025
	05		156.250	160.850	24	24	24	157.200	161.800	75* <sup>1</sup>	75* <sup>1</sup>	75* <sup>1</sup>	156.775	156.775					
05A		05A	156.250	156.250	25	25	25	157.250	161.850	76* <sup>1</sup>	76* <sup>1</sup>	76* <sup>1</sup>	156.825	156.825					
06	06	06	156.300	156.300			25b	RX Only	161.850	77* <sup>1</sup>	77	77* <sup>1</sup>	156.875	156.875					
	07		156.350	160.950	26	26	26	157.300	161.900		78		156.925	161.525					
07A		07A	156.350	156.350	27	27	27	157.350	161.950	78A		78A	156.925	156.925					
08	08	08	156.400	156.400	28	28	28	157.400	162.000		79		156.975	161.575					
09	09	09	156.450	156.450			28b	RX Only	162.000	79A		79A	156.975	156.975					
10	10	10	156.500	156.500		60	60	156.025	160.625		80		157.025	161.625					
11	11	11	156.550	156.550		61		156.075	160.675	80A		80A	157.025	157.025					
12	12	12	156.600	156.600	61A		61A	156.075	156.075		81		157.075	161.675					
13 <sup>1</sup>	13	13 <sup>1</sup>	156.650	156.650		62		156.125	160.725	81A		81A	157.075	157.075					
14	14	14	156.700	156.700			62A	156.125	156.125		82		157.125	161.725					
15 <sup>1</sup>	15 <sup>1</sup>	15 <sup>1</sup>	156.750	156.750		63		156.175	160.775	82A		82A	157.125	157.125					
16	16	16	156.800	156.800	63A			156.175	156.175		83	83	157.175	161.775					
17 <sup>1</sup>	17	17 <sup>1</sup>	156.850	156.850		64	64	156.225	160.825	83A		83A	157.175	157.175					
	18		156.900	161.500	64A		64A	156.225	156.225			83b	RX Only	161.775					
18A		18A	156.900	156.900		65		156.275	160.875	84	84	84	157.225	161.825					
	19		156.950	161.550	65A	65A	65A	156.275	156.275	84A			157.225	157.225					
19A		19A	156.950	156.950		66		156.325	160.925	85	85	85	157.275	161.875					
20	20	20 <sup>1</sup>	157.000	161.600	66A	66A	66A <sup>1</sup>	156.325	156.325	85A			157.275	157.275					
20A			157.000	157.000	67 <sup>1</sup>	67	67	156.375	156.375	86	86	86	157.325	161.925					

<sup>1</sup>Low power only. <sup>2</sup> Australian version only.

## SPECIFICATIONS

General Specifications	
Frequency Range	TX 156.025-157.425MHz
	RX: 156.050-163.275MHz
Type of Emission	FM(16K0G3E)\DSC(16K0G2B)
Frequency Stability	±10ppm
Battery Pack	DC7.4V,1500mAh
Operating Temperature	-15°C ~ +55°C
Dimensions ( W×H×D )	61mm×141mm×43mm
Weight	315g ( with battery, antenna and belt clip )
Waterproof Level	IPX7

GPS Receiver Specifications	
Apply to long-term tracking (when signal strength>-130dBm, 5 satellites visible.)	
TIFF Cold Boot	< 1 minute
TIFF Warm Boot	< 10 seconds
Horizontal position Precision	< 10 meters

Transmitter Specifications	
Output Power	5W\1W
Maximum Frequency Deviation	±5kHz
Spurious Emission	≤0.25μW
Adjacent Channel Power	≥70dB
Audio Harmonic Distortion	≤10%
Current Drain	≤1.5A(High Power)
	≤0.7A(Low Power)
	≤0.2A(Maximum Audio Output)

Receiver Specifications	
Receive Sensitivity	<0.22μV
Scquelch Sensitivity	<0.22μV
HUM and Noise	>40dB
Adjacent Channel Selectivity	>70dB
Spurious Response Rejection Ratio	>70dB
Intermodulation Rejection Ratio	>68dB
Audio Output Power	>0.5W ( 10% )

## TROUBLESHOOTING

PROBLEM	POSSIBLE CAUSE	SOLUTION	REF.
Cannot power on.	<ul style="list-style-type: none"> <li>● The battery is exhausted.</li> <li>● The battery is not installed well.</li> </ul>	<ul style="list-style-type: none"> <li>● Charge the battery pack.</li> <li>● Well install the battery pack.</li> </ul>	<ul style="list-style-type: none"> <li>● 1, 2</li> <li>● 2, 3</li> </ul>
Cannot transmit or transmit in high power is incapable.	<ul style="list-style-type: none"> <li>● Some channels are limited to low power transmit.</li> <li>● The battery is exhausted</li> <li>● Low power transmit.</li> <li>● Work in Weather Channel or Channel 70.</li> </ul>	<ul style="list-style-type: none"> <li>● Switch to channels without output power limit.</li> <li>● Charge the battery pack.</li> <li>● Press [HI/LO] to select high power transmit.</li> <li>● Exit Weather Channel or Channel 70.</li> </ul>	<ul style="list-style-type: none"> <li>● 6, 7</li> <li>● 1, 2</li> <li>● 6</li> <li>● 6</li> </ul>
Cannot not change channel.	<ul style="list-style-type: none"> <li>● The keypad is locked.</li> </ul>	<ul style="list-style-type: none"> <li>● Press and hold [LOCK] for 1.5 seconds to turn OFF the key lock function.</li> </ul>	<ul style="list-style-type: none"> <li>● 10</li> </ul>
Cannot scan.	<ul style="list-style-type: none"> <li>● No TAG channels are set.</li> </ul>	<ul style="list-style-type: none"> <li>● Set TAG channels.</li> </ul>	<ul style="list-style-type: none"> <li>● 11</li> </ul>
Cannot communicate in the same channel.	<ul style="list-style-type: none"> <li>● The channel is duplex (DUP).</li> <li>● Work in self-set channel group.</li> </ul>	<ul style="list-style-type: none"> <li>● Select channel.</li> <li>● Set the same channel frequency.</li> </ul>	<ul style="list-style-type: none"> <li>● 8</li> <li>● 8</li> </ul>
No key beep.	<ul style="list-style-type: none"> <li>● The key beep is turned OFF.</li> </ul>	<ul style="list-style-type: none"> <li>● Turn ON the key beep in the set mode.</li> </ul>	<ul style="list-style-type: none"> <li>● 51</li> </ul>
No sound from loudspeaker.	<ul style="list-style-type: none"> <li>● The squelch level is too high.</li> <li>● The volume level is too low.</li> <li>● Water ingress in loudspeaker.</li> </ul>	<ul style="list-style-type: none"> <li>● Set the proper squelch level.</li> <li>● Press [VOL] and then press [▲]/[▼] to turn up the volume.</li> <li>● Drain water from loudspeaker.</li> </ul>	<ul style="list-style-type: none"> <li>● 7</li> <li>● 7</li> <li>● 10</li> </ul>
Cannot transmit distress call.	<ul style="list-style-type: none"> <li>● No MMSI code is set.</li> </ul>	<ul style="list-style-type: none"> <li>● Set MMSI code.</li> </ul>	<ul style="list-style-type: none"> <li>● 13</li> </ul>





# **VHF Marine Radio**

