



Olorin AB is a well established Swedish company within the maritime sector that offers our own brand of monitors with dimming, sunlight readable and a wide range of input and mounting options.



Olorin Maritime 2022

Head office

Olorin AB
Arendalsvägen 40
SE-434 39 Kungsbacka
SWEDEN

Telephone

+46 (0)300 56 67 80

E-mail

info@olorin.com

Website

www.olorin.com

Opening hours

Monday - Friday, 08.00- 17.00 CET



NEW generation of maritime Olorin monitors in the classic form factor.

VLD159

15"

VLD179

17"

VLD199

19"

VLD229

21.5"

VLD249

24"



Olorin's new MAV main board platform

9V to 36V

Olorin's new monitors can be connected with 9V to 36V, making them much more versatile for configurations with different DC setups.

Command & Control

Olorin's new lineup of monitors have support for RS232 command & control for easier adjustment of the dimming and settings.

HDMI & DisplayPort

The VLDxx9 lineup of monitors have support for modern video standards such as HDMI and DP, along with legacy inputs such as DVI, VGA and CVBS (BNC).

Fully featured maritime monitors with dimming and optional sunlight readable filter

Dimming



Olorin monitors are fully dimmable, this means that they keep the contrast when you decrease the brightness from 100 to 0%, keeping the helmsman's vision intact during complete darkness.

Sunlight readable



The monitors can be fitted with a Sunlight Readable filter, a polarizing screen layer which makes the monitors fully readable in strong sunlight, making important information always clearly visible.

Touch panel



Interactive touch screens are a common tool in our everyday life, Olorin monitors are designed to be easily customized with multi touch for environments where there's no room for a keyboard or mouse.

External OSD



External control for OSD and dimming, connected via RJ45 or RS232. Perfect solution for remote adjustments of monitors. Olorin's high end models have GPIO for software integration.



Mounting frames

Olorin offers a variety of mounting solutions, such as flush mounting, These are prepared with external OSD for dimming. Olorin also offers mounting arms and solid base units that can be fitted on a table or in the ceiling.

Crystal clear imaging



Olorin strive for high quality imaging and as such, use high end VA and IPS displays to secure your work environment. Olorin's 27" and 55" monitors have a color depth of 1.07 Billion, which means reliable clarity.

Picture by Picture



Olorin 27" and 55" monitors with Ultra HD resolution can output a total of four inputs at the same time with Picture in Picture. These models are also very versatile with Zoom and Profile functionality.

Varied input options

The world is going digital and Olorin is no exception, we offer advanced video monitors with DVI, DisplayPort but also CVBS (BNC) and S-video (Mini DIN) for legacy systems.



Olorin VLD159



Olorin VLD159 is designed for specialists in maritime and other demanding environments where rugged equipment is of the utmost importance.

Excellent image quality

Olorin VLD159 features a standard XGA resolution which makes it compatible with the majority of hardware out there. The monitor has optional anti-reflective (Sunlight readable) filter for sunny days.

Connectivity

Olorin VLD159 has multiple video inputs for users who want to get the most out of their monitor. It supports DisplayPort, HDMI, DVI and analog inputs such as VGA and CVBS. The monitor can also be connected to Olorin's external OSD for dimming.

This monitor also has optional PCAP multi touch for user interaction.

Suitable for demanding environments

The monitor has a rugged construction and optional protective glass in order to be used in working environments such as maritime. Olorin VLD159 features a dimmable backlight, to make sure the operator can work even in complete darkness on the sea without having the monitor's contrast being compromised.

15" Monitor with Dimming

- 15" monitor with 1024 x 768 resolution
- Dimming for night time operation
- Multiple video inputs for a variety of equipment

Specification

LCD Panel	Backlight Type	WLED
	Screen Technology	TN
	Surface Treatment	Antiglare, Hard coating (3H)
	Screen Size, Diagonal	15.0"
	Screen Size, H/V	304.128 x 228.096 mm
	Aspect Ratio	4:3
	Resolution	1024 x 768, XGA
	Color Depth	262K/16.2M, 60% NTSC
	Contrast Ratio	800:1 (Typ.) (TM)
	Luminance	350 cd/m ² (Typ.)
	Viewing Angles	160 / 150 (Typ.)
	Response Time	8 ms (Typ.)
	Refresh Rate	60 Hz
Display Modes	Temperature	Cool, Neutral, Warm, User
Features	Dimming	Olorin Dimming, 0 to 100%
	Video Scaling	Full, 1:1, 4:3, 5:4, 16:9
	Video Inputs	DisplayPort
	DVI	DVI-I 29 pin x1 (DVI-A/DVI-D)
	HDMI	HDMI x 1
	CVBS	BNC x 1
Control Inputs	Serial Command, RS-232	D-sub 9 pin x 1
	Olorin External OSD	RJ45 x 1
Touch Panel	Touch Type	PCAP (Optional)
	Touch Input, USB	USB-B x 1
	Touch Input, RS-232	D-sub 9 pin x 1
USB	Firmware Upload	Micro USB x 1
Audio	Audio Input	Phone Jack 3.5mm x 1
	Speakers	2W x 2
Power	Power Input Type	External adapter
	Power Input Rating	100-240Vac, 1.8A, 50-60 Hz
	Adapter Power Output Rating	12V 4.5 A
	DC Input	9V~36V
	DC Connector	4 Pin
	Power consumption	Full Brightness: 25 W Power Saving: 1.5 W

Mechanical	Dimensions w/o Base Unit	347.43 x 271.43 x 58 mm
	Weight w/o Base Unit	2.8 (Approx) Kgs
	Housing Color	Black
	Housing Material	Plastic (PC+ABS)
	IP Rating *	IP 65 (Front bezel only, optional)
	Mounting Standard, VESA	100 x 100 mm
	OSD Interface	Potentiometer on Right Side
	OSD Lock	Yes
	Anti Reflective Film	Sunlight readable (optional)
	Screen Protection	Glass True Flat (optional)
	Security slot	Kensington Security Slot
	Ground bolt	Potential equalization bolt
Compliance	EU	CE (EN62368-1, EN55032/EN55035, Rohs, WEEE)
	EU Energy efficiency class	G
Warranty	DOA	Three (3) months, max. 500 h.
	Standard	Two (2) years

Order no. Monitor

Order no.	Order no. Dimming Kit	Description
VLD15906	VLD15906D	Default
VLD15906S	VLD15906DS	w/ Sunlight readable filter
VLD15906GTF	VLD15906DGTF	w/ Screen Protection IP65 *
VLD15906PCAP	VLD15906DPCAP	w/ PCAP Touch panel IP65 *

Order no. Accessories

Order no.	Description
XAVLD98415	Flush mounting frame
XAVL22012	Base unit, standard desktop
XAVL98200	Multi attachment Slim
XAVL98201	Multi attachment
XAVL9850x	External OSD (1, 2 or 4 ports)
XAVL99035	DVI to VGA & DVI splitter cable
XAVL99041	12V 4-pin cable (included with Dimming Kit)



VistaLine VLD159

Measurements

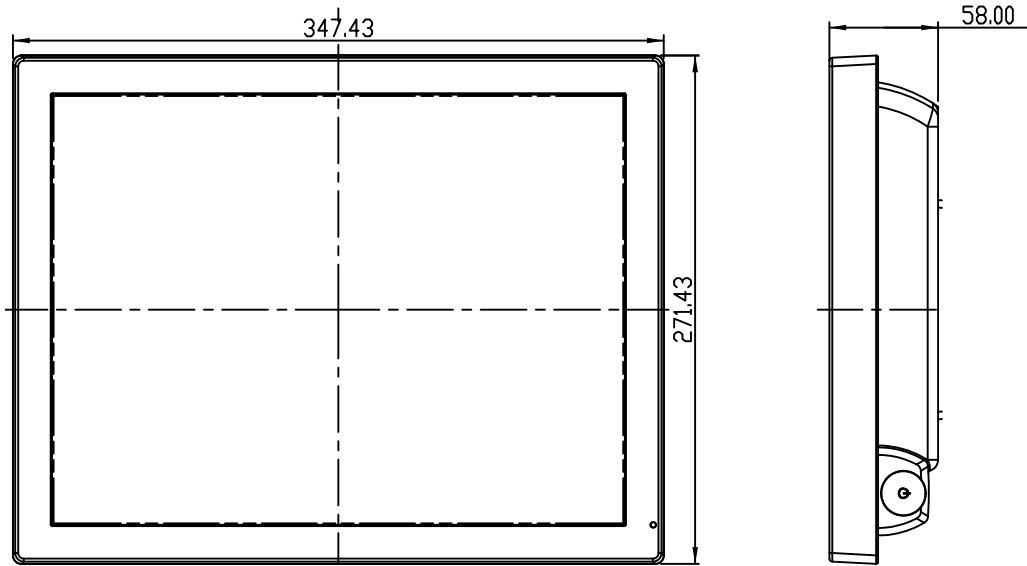

Measurements for Flush mounting frame

Order no. : **XAVLD98415**

	Outer dimensions	Cut out dimensions
Width	393 mm	355 mm
Height	317 mm	276 mm

Additional cut out for OSD circuit and back plate might be necessary.

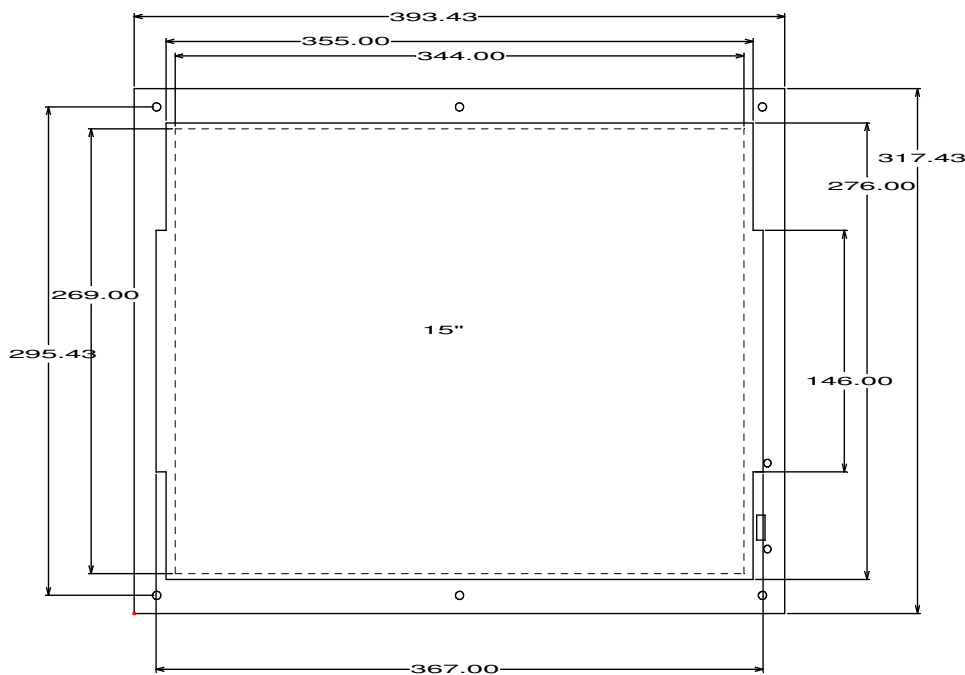

External OSD, 2 ports
XAVL98502



Multi attachment
XAVL98201



Olorin VLD179



Olorin VLD179 is designed for specialists in maritime and other demanding environments where rugged equipment is of the utmost importance.

Excellent image quality

Olorin VLD179 features a standard SXGA resolution which makes it compatible with the majority of hardware out there.

Connectivity

Olorin VLD179 has multiple video inputs for users who want to get the most out of their monitor. It supports DisplayPort, HDMI, DVI and analog inputs such as VGA and CVBS. The monitor can also be connected to Olorin's external OSD for dimming.

Suitable for demanding environments

The monitor has a rugged construction and optional protective glass in order to be used in working environments such as maritime. Olorin VLD179 features a dimmable backlight, to make sure the operator can work even in complete darkness on the sea without having the monitor's contrast being compromised.

17" Monitor with Dimming

- 17" monitor with 1280 x 1024 resolution
- Dimming for night time operation
- Multiple video inputs for a variety of equipment

Specification

LCD Panel	Backlight Type	WLED
	Screen Technology	TN
	Surface Treatment	Antiglare, Hard coating (3H)
	Screen Size, Diagonal	17.0"
	Screen Size, H/V	337.92 x 270.336 mm
	Aspect Ratio	5:4
	Resolution	1280 x 1024, SXGA
	Color Depth	16.7M, 72% NTSC
	Contrast Ratio	1000:1 (Typ.) (TM)
	Luminance	350 cd/m ² (Typ.)
	Viewing Angles	170 / 160 (Typ.)
	Response Time	5 ms (Typ.)
	Refresh Rate	60 Hz
Display Modes	Temperature	Cool, Neutral, Warm, User
Features	Dimming	Olorin Dimming, 0 to 100%
	Video Scaling	Full, 1:1, 4:3, 5:4, 16:9
Video Inputs	DisplayPort	DisplayPort x 1
	DVI	DVI-I 29 pin x1 (DVI-A/DVI-D)
	HDMI	HDMI x 1
	CVBS	BNC x 1
Control Inputs	Serial Command, RS-232	D-sub 9 pin x 1
	Olorin External OSD	RJ45 x 1
Touch Panel	Touch Type	N/A
	Touch Input, USB	-
	Touch Input, RS-232	-
USB	Firmware Upload	Micro USB x 1
Audio	Audio Input	Phone Jack 3.5mm x 1
	Speakers	2W x 2
Power	Power Input Type	External adapter
	Power Input Rating	100-240Vac, 1.8A, 50-60 Hz
	Adapter Power Output Rating	12V 4.5 A
	DC Input	9V~36V
	DC Connector	4 Pin
	Power consumption	Full Brightness: 25 W Power Saving: 1.5 W

Mechanical	Dimensions w/o Base Unit	385 x 317 x 62.8 mm
	Weight w/o Base Unit	3.8 (Approx) Kgs
	Housing Color	Black
	Housing Material	Plastic (PC+ABS)
	IP Rating *	IP 65 (Front bezel only, optional)
	Mounting Standard, VESA	100 x 100 mm
	OSD Interface	Potentiometer on Right Side
	OSD Lock	Yes
	Anti Reflective Film	N/A
	Screen Protection	Glass True Flat (Optional)
	Security slot	Kensington Security Slot
	Ground bolt	Potential equalization bolt
	Compliance	EU
	EU Energy efficiency class	G
	Warranty	DOA
	Standard	Two (2) years

Order no. Monitor

Order no.	Order no. Dimming Kit	Description
VLD17906	VLD17906D	Default
VLD17906GTF	VLD17906DGTF	w/ Screen Protection IP65 *

Order no. Accessories

Order no.	Description
XAVLD98417	Flush mounting frame
XAVL22012	Base unit, standard desktop
XAVL98200	Multi attachment Slim
XAVL98201	Multi attachment
XAVL9850x	External OSD (1, 2 or 4 ports)
XAVL99035	DVI to VGA & DVI splitter cable
XAVL99041	12V 4-pin cable (included with Dimming Kit)



VistaLine VLD179

Measurements

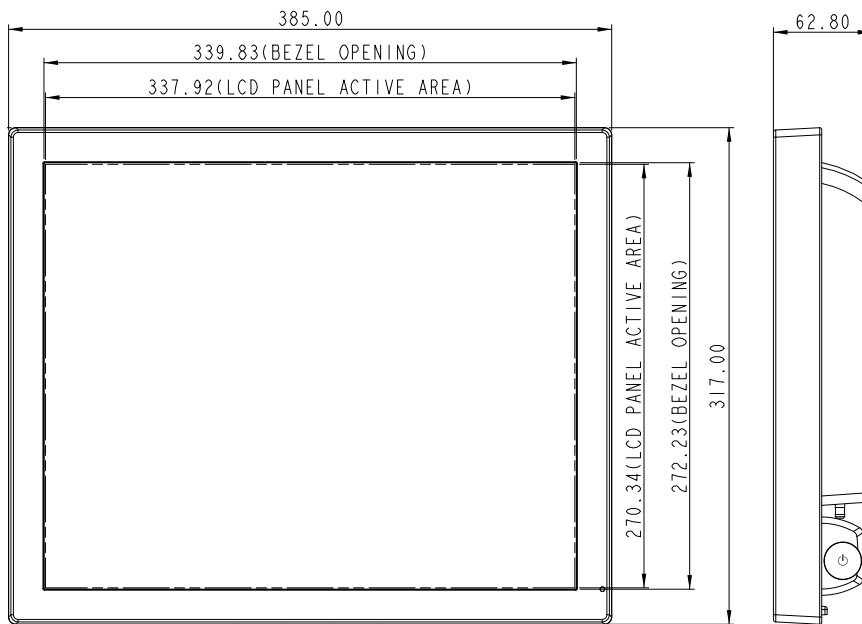

Measurements for Flush mounting frame

Order no. : **XAVLD98417**

	Outer dimensions	Cut out dimensions
Width	432 mm	394 mm
Height	363 mm	324 mm

Additional cut out for OSD circuit and back plate might be necessary.

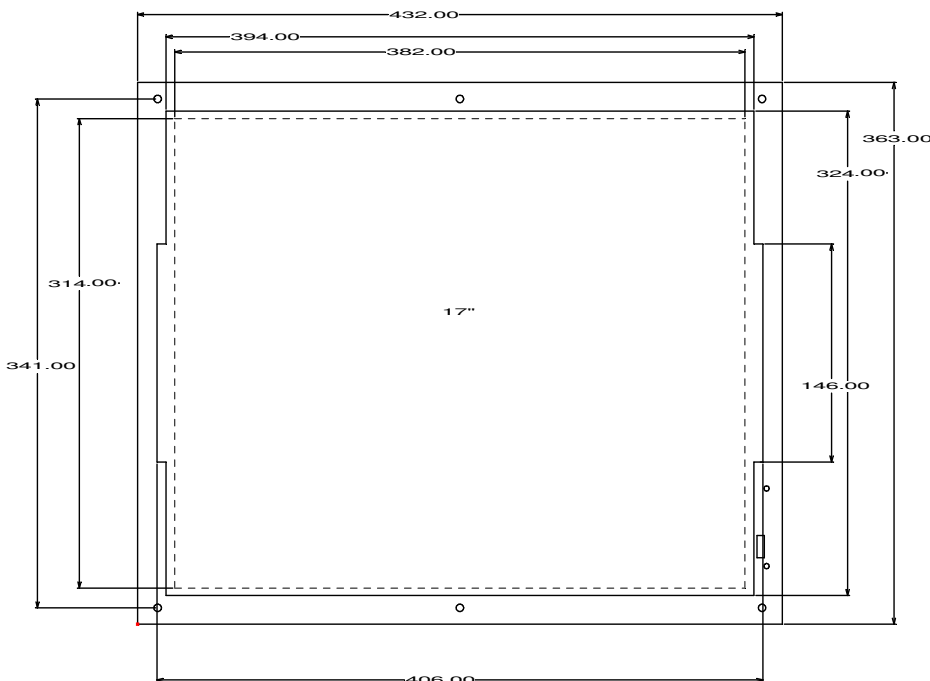

External OSD, 2 ports
XAVL98502



Multi attachment
XAVL98201



Olorin VLD199



Olorin VLD199 is designed for specialists in maritime and other demanding environments where rugged equipment is of the utmost importance.

Excellent image quality

Olorin VLD199 features a standard SXGA resolution which makes it compatible with the majority of hardware out there. The monitor has optional anti-reflective (Sunlight readable) filter for sunny days.

Connectivity

Olorin VLD199 has multiple video inputs for users who want to get the most out of their monitor. It supports DisplayPort, HDMI, DVI and analog inputs such as VGA and CVBS. The monitor can also be connected to Olorin's external OSD for dimming.

This monitor also has optional PCAP multi touch for user interaction.

Suitable for demanding environments

The monitor has a rugged construction and optional protective glass in order to be used in working environments such as maritime. Olorin VLD199 features a dimmable backlight, to make sure the operator can work even in complete darkness on the sea without having the monitor's contrast being compromised.

19" Monitor with Dimming

- 19" monitor with 1280 x 1024 resolution
- Dimming for night time operation
- Multiple video inputs for a variety of equipment

Specification

LCD Panel	Backlight Type	WLED
	Screen Technology	AHVA
	Surface Treatment	Antiglare
	Screen Size, Diagonal	19.0"
	Screen Size, H/V	376.32 x 301.056 mm
	Aspect Ratio	5:4
	Resolution	1280 x 1024, SXGA
	Color Depth	16.7M, 72% NTSC
	Contrast Ratio	1000:1 (Typ.) (TM)
	Luminance	300 cd/m ² (Typ.)
	Viewing Angles	178 / 178 (Typ.)
	Response Time	25 ms (Typ.)
	Refresh Rate	60 Hz
Display Modes	Temperature	Cool, Neutral, Warm, User
Features	Dimming	Olorin Dimming, 0 to 100%
	Video Scaling	Full, 1:1, 4:3, 5:4, 16:9
Video Inputs	DisplayPort	DisplayPort x 1
	DVI	DVI-I 29 pin x1 (DVI-A/DVI-D)
	HDMI	HDMI x 1
	CVBS	BNC x 1
Control Inputs	Serial Command, RS-232	D-sub 9 pin x 1
	Olorin External OSD	RJ45 x 1
Touch Panel	Touch Type	PCAP (Optional)
	Touch Input, USB	USB-B x 1
	Touch Input, RS-232	D-sub 9 pin x 1
USB	Firmware Upload	Micro USB x 1
Audio	Audio Input	Phone Jack 3.5mm x 1
	Speakers	2W x 2
Power	Power Input Type	External adapter
	Power Input Rating	100-240Vac, 1.8A, 50-60 Hz
	Adapter Power Output Rating	12V 4.5 A
	DC Input	9V~36V
	DC Connector	4 Pin
	Power consumption	Full Brightness: 35W Power Saving: 1.5W

Mechanical	Dimensions w/o Base Unit	429.2 x 354.21 x 65 mm
	Weight w/o Base Unit	4.7 (Approx) Kgs
	Housing Color	Black
	Housing Material	Plastic (PC+ABS)
	IP Rating *	IP 65 (Front bezel only, optional)
	Mounting Standard, VESA	100 x 100 mm
	OSD Interface	Potentiometer on Right Side
	OSD Lock	Yes
	Anti Reflective Film	Sunlight readable (Optional)
	Screen Protection	Glass True Flat (Optional)
Security slot	Kensington Security Slot	
Ground bolt	Potential equalization bolt	
Compliance	EU	CE (EN62368-1, EN55032/EN55035, Rohs, WEEE)
	EU Energy efficiency class	G
Warranty	DOA	Three (3) months, max. 500 h.
	Standard	Two (2) years

Order no. Monitor

Order no.	Order no. Dimming Kit	Description
VLD19906	VLD19906D	Default
VLD19906S	VLD19906DS	w/ Sunlight readable filter
VLD19906GTF	VLD19906DGTF	w/ Screen protection IP65 *
VLD19906PCAP	VLD19906DPCAP	w/ PCAP Touch panel IP65 *

Order no. Accessories

Order no.	Description
XAVLD98419	Flush mounting frame
XAVL22012	Base unit, standard desktop
XAVL98200	Multi attachment Slim
XAVL98201	Multi attachment
XAVL9850x	External OSD (1, 2 or 4 ports)
XAVL99035	DVI to VGA & DVI splitter cable
XAVL99041	12V 4-pin cable (included with Dimming Kit)



VistaLine VLD199

Measurements

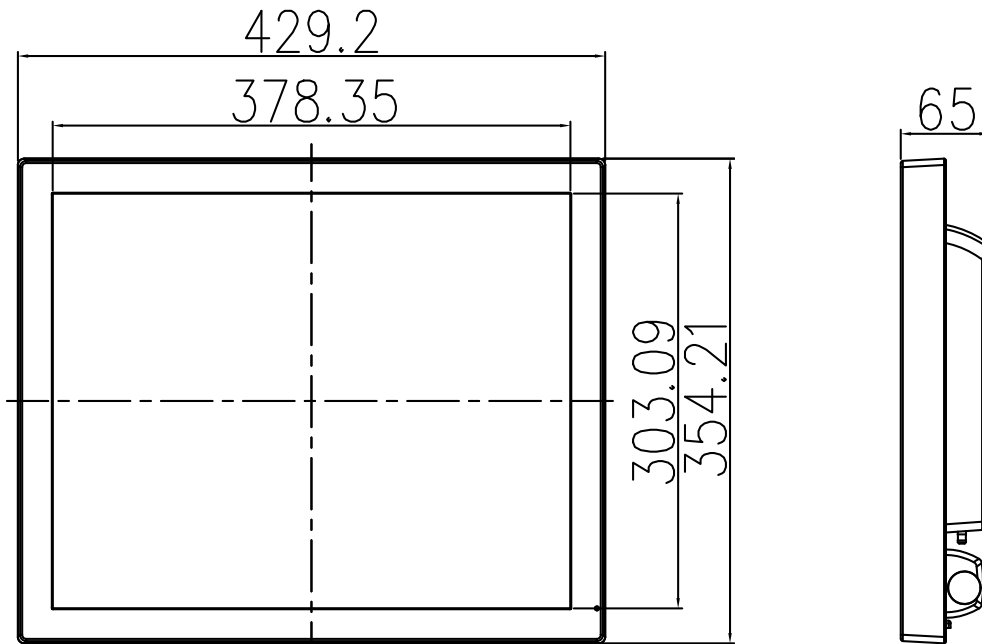

Measurements for Flush mounting frame

Order no. : **XAVLD98419**

	Outer dimensions	Cut out dimensions
Width	476 mm	440 mm
Height	400 mm	363 mm

Additional cut out for OSD circuit and back plate might be necessary.

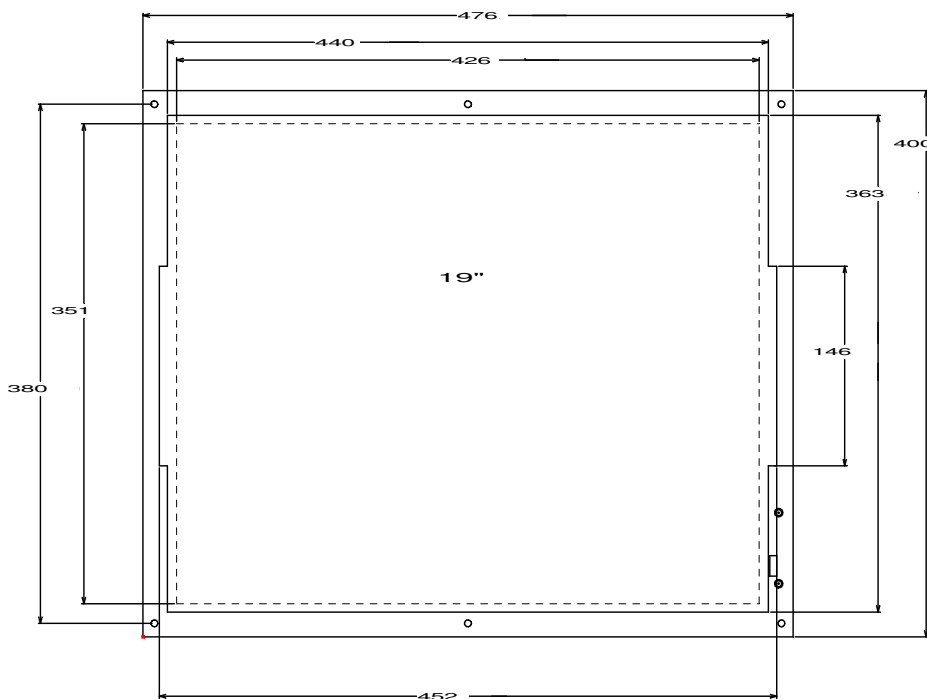

External OSD, 2 ports
XAVL98502



Multi attachment
XAVL98201



Olorin VLD229



Olorin VLD229 is designed for specialists in maritime and other demanding environments where rugged equipment is of the utmost importance.

Excellent image quality

Olorin VLD229 features a standard Full HD resolution which makes it compatible with the majority of hardware out there.

Connectivity

Olorin VLD229 has multiple video inputs for users who want to get the most out of their monitor. It supports DisplayPort, HDMI, DVI and analog inputs such as VGA and CVBS. The monitor can also be connected to Olorin's external OSD for dimming.

This monitor also has optional PCAP multi touch for user interaction.

Suitable for demanding environments

The monitor has a rugged construction and optional protective glass in order to be used in working environments such as maritime. Olorin VLD229 features a dimmable backlight, to make sure the operator can work even in complete darkness on the sea without having the monitor's contrast being compromised.

21.5" Monitor with Dimming

- 21.5" monitor with 1920 x 1080 resolution
- Dimming for night time operation
- Multiple video inputs for a variety of equipment

Specification

LCD Panel	Backlight Type	WLED
	Screen Technology	AHVA
	Surface Treatment	Antiglare, Hard coating (3H)
	Screen Size, Diagonal	21.5"
	Screen Size, H/V	476.064 x 267.786 mm
	Aspect Ratio	16:9
	Resolution	1920 x 1080, FHD
	Color Depth	16.7M, 72% NTSC
	Contrast Ratio	1000:1 (Typ.) (TM)
	Luminance	350 cd/m ² (Typ.)
	Viewing Angles	178 / 178 (Typ.)
	Response Time	22 ms (Typ.)
	Refresh Rate	60 Hz
Display Modes	Temperature	Cool, Neutral, Warm, User
Features	Dimming	Olorin Dimming, 0 to 100%
	Video Scaling	Full, 1:1, 4:3, 5:4, 16:9
Video Inputs	DisplayPort	DisplayPort x 1
	DVI	DVI-I 29 pin x1 (DVI-A/DVI-D)
	HDMI	HDMI x 1
	CVBS	BNC x 1
Control Inputs	Serial Command, RS-232	D-sub 9 pin x 1
	Olorin External OSD	RJ45 x 1
Touch Panel	Touch Type	PCAP (Optional)
	Touch Input, USB	USB-B x 1
	Touch Input, RS-232	D-sub 9 pin x 1
USB	Firmware Upload	Micro USB x 1
Audio	Audio Input	Phone Jack 3.5mm x 1
	Speakers	2W x 2
Power	Power Input Type	External adapter
	Power Input Rating	100-240Vac, 1.8A, 50-60 Hz
	Adapter Power Output Rating	12V 4.5 A
	DC Input	9V~36V
	DC Connector	4 Pin
	Power consumption	Full Brightness: 30W Power Saving: 2.5W

Mechanical	Dimensions w/o Base Unit	537.37 x 328.87 x 59 mm
	Weight w/o Base Unit	5.8 Kgs
	Housing Color	Black
	Housing Material	Plastic (PC+ABS)
	IP Rating *	IP 65 (Front bezel only, optional)
	Mounting Standard, VESA	100 x 100 mm
	OSD Interface	Potentiometer on Right Side
	OSD Lock	Yes
	Anti Reflective Film	N/A
	Screen Protection	Glass True Flat (Optional)
Security slot	Kensington Security Slot	
Ground bolt	Potential equalization bolt	
Compliance	EU	CE (EN62368-1, EN55032/EN55035, Rohs, WEEE)
	EU Energy efficiency class	G
Warranty	DOA	Three (3) months, max. 500 h.
	Standard	Two (2) years

Order no. Monitor

Order no.	Order no. Dimming Kit	Description
VLD22906	VLD22906D	Default
VLD22906GTF	VLD22906DGTF	w/ Screen Protection IP65 *
VLD22906PCAP	VLD22906DPCAP	w/ PCAP Touch panel IP65 *

Order no. Accessories

Order no.	Description
XAVLD98422	Flush mounting frame
XAVL22012	Base unit, standard desktop
XAVL98200	Multi attachment Slim
XAVL98201	Multi attachment
XAVL9850x	External OSD (1, 2 or 4 ports)
XAVL99035	DVI to VGA & DVI splitter cable
XAVL99041	12V 4-pin cable (included with Dimming Kit)



VistaLine VLD229

Measurements

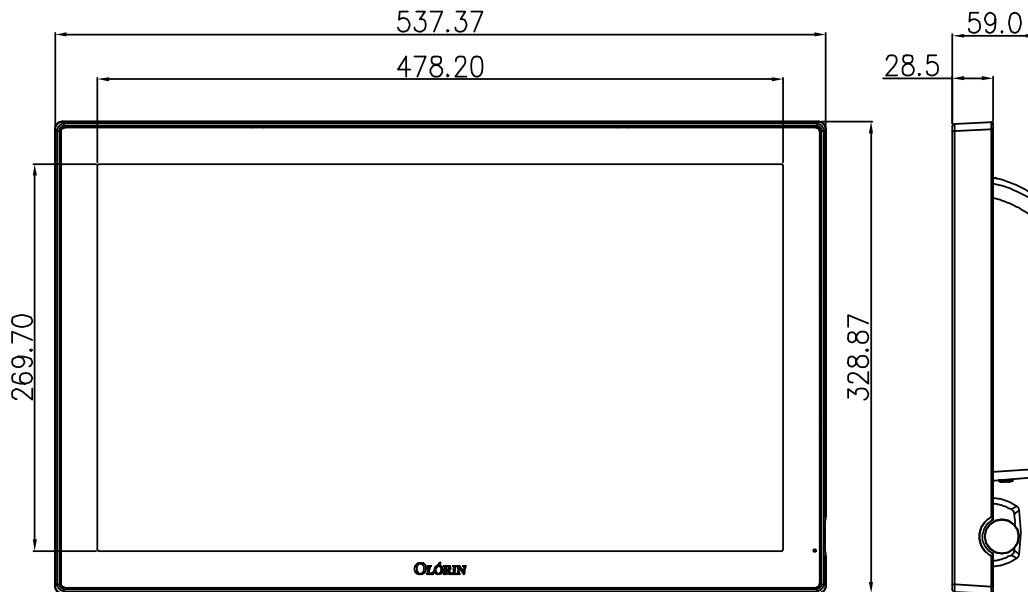

Measurements for Flush mounting frame

Order no. : **XAVLD98422**

	Outer dimensions	Cut out dimensions
Width	583 mm	548 mm
Height	375 mm	338 mm

Additional cut out for OSD circuit and back plate might be necessary.

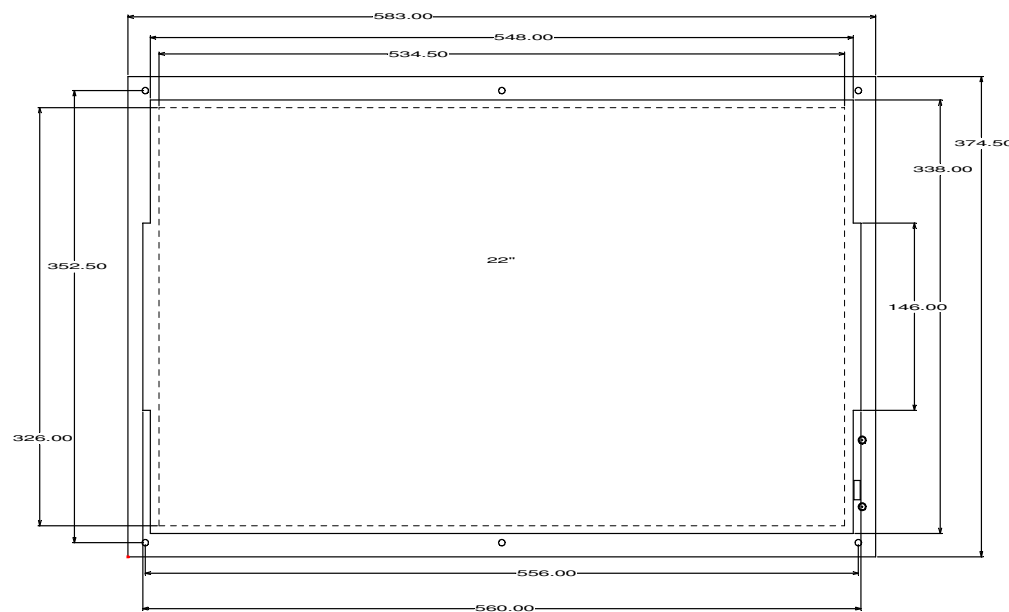

External OSD, 2 ports
XAVL98502



Multi attachment
XAVL98201



Olorin VLD249



Olorin VLD249 is designed for specialists in maritime and other demanding environments where rugged equipment is of the utmost importance.

Excellent image quality

Olorin VLD249 features a standard Full HD resolution which makes it compatible with the majority of hardware out there.

Connectivity

Olorin VLD249 has multiple video inputs for users who want to get the most out of their monitor. It supports DisplayPort, HDMI, DVI and analog inputs such as VGA and CVBS. The monitor can also be connected to Olorin's external OSD for dimming.

Suitable for demanding environments

The monitor has a rugged construction and optional protective glass in order to be used in working environments such as maritime. Olorin VLD249 features a dimmable backlight, to make sure the operator can work even in complete darkness on the sea without having the monitor's contrast being compromised.

24" Monitor with Dimming

- 24" monitor with 1920 x 1080 resolution
- Dimming for night time operation
- Multiple video inputs for a variety of equipment

Specification

LCD Panel	Backlight Type	WLED
	Screen Technology	AMVA3
	Surface Treatment	Antiglare, Hard coating (3H)
	Screen Size, Diagonal	24.0"
	Screen Size, H/V	531.36 x 298.89 mm
	Aspect Ratio	16:9
	Resolution	1920 x 1080, FHD
	Color Depth	16.7M, 72% NTSC
	Contrast Ratio	5000:1 (Typ.) TM
	Luminance	300 cd/m ² (Typ.)
	Viewing Angles	178 / 178 (Typ.)
	Response Time	25 ms (Typ.)
	Refresh Rate	60 Hz
Display Modes	Temperature	Cool, Neutral, Warm, User
Features	Dimming	Olorin Dimming, 0 to 100%
	Video Scaling	Full, 1:1, 4:3, 5:4, 16:9
Video Inputs	DisplayPort	DisplayPort x 1
	DVI	DVI-I 29 pin x1 (DVI-A/DVI-D)
	HDMI	HDMI x 1
	CVBS	BNC x 1
Control Inputs	Serial Command, RS-232	D-sub 9 pin x 1
	Olorin External OSD	RJ45 x 1
Touch Panel	Touch Type	N/A
	Touch Input, USB	-
	Touch Input, RS-232	-
USB	Firmware Upload	Micro USB x 1
Audio	Audio Input	Phone Jack 3.5mm x 1
	Speakers	2W x 2
Power	Power Input Type	External adapter
	Power Input Rating	100-240Vac, 1.8A, 50-60 Hz
	Adapter Power Output Rating	12V 4.5 A
	DC Input	9V~36V
	DC Connector	4 Pin
	Power consumption	Full Brightness: 30W Power Saving: 2.5W

Mechanical	Dimensions w/o Base Unit	582.07 x 350.07 x 62.5 mm
	Weight w/o Base Unit	7.4 kgs
	Housing Color	Black
	Housing Material	Plastic (PC+ABS)
	IP Rating *	IP 65 (Front bezel only)
	Mounting Standard, VESA	100 x 100 mm
	OSD Interface	Potentiometer on Right Side
	OSD Lock	Yes
	Anti Reflective Film	N/A
	Screen Protection	Glass True Flat (Optional)
Compliance	EU	CE (EN62368-1, EN55032/EN55035, Rohs, WEEE)
	EU Energy efficiency class	G
	Warranty	DOA
	Standard	Two (2) years

Order no. Monitor

Order no.	Order no. Dimming Kit	Description
VLD24906	VLD24906D	Default
VLD24906GTF	VLD24906DGTF	w/ Screen Protection IP65 *

Order no. Accessories

Order no.	Description
XAVLD98424	Flush mounting frame
XAVL22012	Base unit, standard desktop
XAVL98200	Multi attachment Slim
XAVL98201	Multi attachment
XAVL9850x	External OSD (1, 2 or 4 ports)
XAVL99035	DVI to VGA & DVI splitter cable
XAVL99041	12V 4-pin cable (included with Dimming Kit)



VistaLine VLD249

Measurements

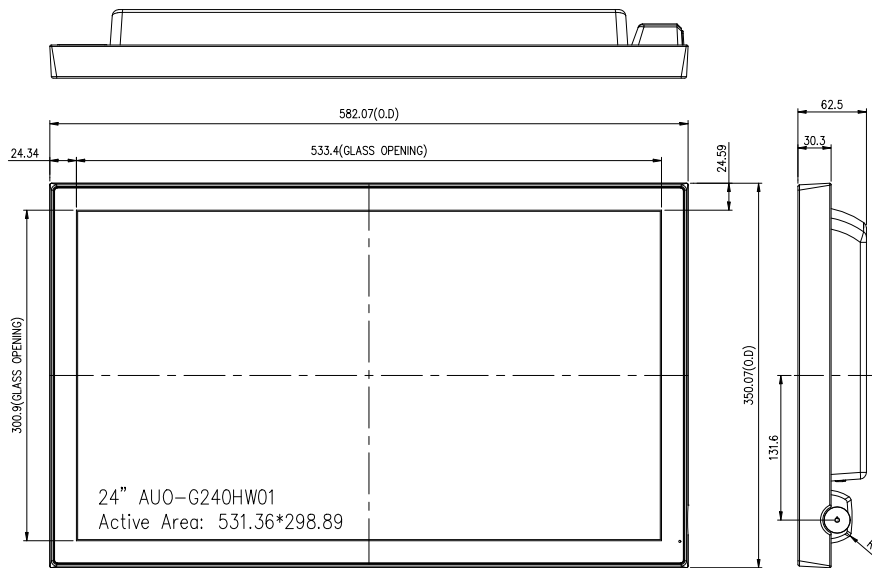

Measurements for Flush mounting frame

Order no. : **XAVLD98424**

	Outer dimensions	Cut out dimensions
Width	628 mm	593 mm
Height	396 mm	359 mm

Additional cut out for OSD circuit and back plate might be necessary.

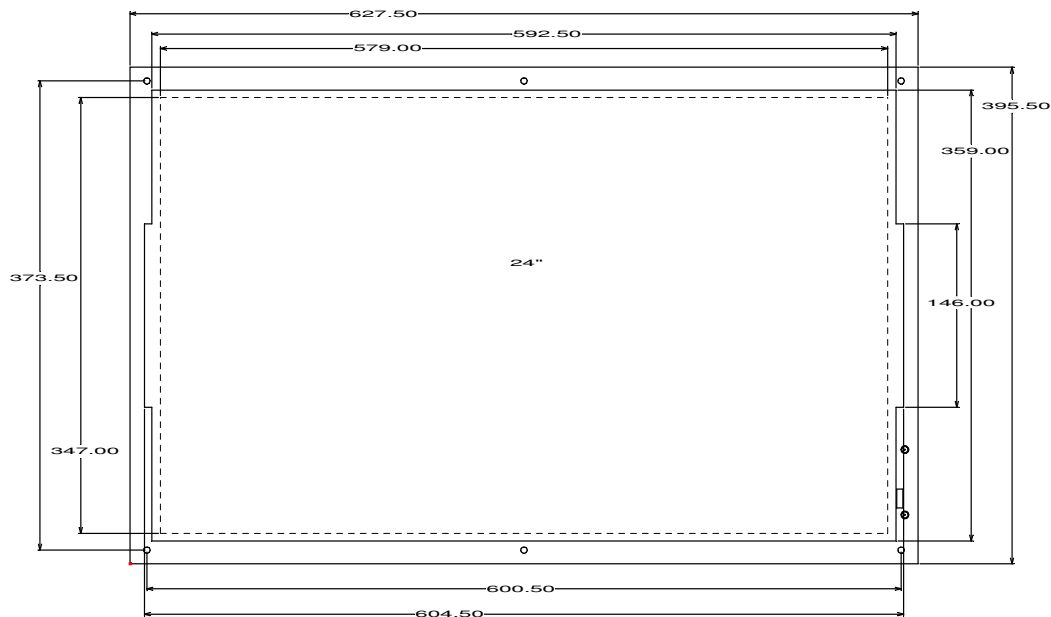

External OSD, 2 ports
XAVL98502



Multi attachment
XAVL98201



VistaLine VLG240

VLG24006GTF



Full HD Monitor for Maritime

- 23.8" monitor with 1920 x 1080 resolution
- Dimming for night time operation
- Multiple digital video inputs for a variety of equipment

Specification

LCD Panel	Backlight Type	WLED
	Screen Technology	VA
	Surface Treatment	Antiglare, Hard coating (3H)
	Screen Size, Diagonal	23.8"
	Screen Size, H/V	527.04 x 296.46 mm
	Aspect Ratio	16:9
	Resolution	1920 x 1080, FHD
	Color Depth	16.7M, 72% NTSC
	Contrast Ratio	3000 : 1 (Typ.)
	Luminance	250 cd/m ² (Typ.)
	Viewing Angles	178 / 178
	Response Time	26 ms
	Refresh Rate	60 Hz
	Display Modes	Gamma
Temperature		Cool, Neutral, Warm, User (RGB)
Features	Automatic Luminance Control	N/A
	Dimming	Olorin Dimming, 0 to 100 %
	Scaling	N/A
Video Inputs	DisplayPort	DisplayPort 1.2a x 1
	DVI	DVI-I Dual Link x 1
	HDMI	HDMI 1.3 Type A x 1
	VGA	D-sub 15 pin x 1
Control Inputs	Serial Command, RS-232	D-sub 9 pin x 1
	Olorin External OSD	RJ45 x 1
Touch panel	Touch Type	PCAP (Optional, project based)
Power	Power Input Type	External adapter
	Power Input Rating	100-240Vac, 50/60Hz
	Adapter Power Output Rating	24V 2.71A
	DC Input	24V
	DC Connector	4 Pin
	Power consumption	Full Brightness: 100 W Power Saving: 2 W

Olorin VLG240 is designed for specialists in maritime and other demanding environments where rugged equipment is of the utmost importance.

Excellent image quality

Olorin VLG240 features a standard Full HD resolution which makes it compatible with the majority of hardware out there. The monitor's wide viewing angles makes it easier for several operators to view the same image at once.

Connectivity

Olorin VLG240 has multiple video inputs for users who want to get the most out of their monitor. It supports HDMI, DisplayPort, VGA and DVI. The monitor can also be connected to Olorin's external OSD for dimming, and via RS-232 for serial communication and control.

Suitable for demanding environments

The monitor has an aluminum casing and protective glass in order to be used in working environments such as maritime. Olorin VLG240 features a dimmable backlight, to make sure the operator can work even in complete darkness on the sea without having the monitor's contrast being compromised.

The monitor's VESA mount can be used to attach it to lots of different arms and base units, making the Olorin VLG240 very versatile.

Mechanical	Dimensions without Base Unit	584.8 x 365.2 x 53 mm
	Weight without Base Unit	5.47 Kgs
	Housing Color	Black
	Housing Material	Aluminum
	IP Rating	IP 65 in front
	Mounting Standard, VESA	100 x 100 mm, 200 x 100 mm
	LED Indicator	Green: ON Orange: Stand-by
	OSD Interface	Sensor Keys on Front Bezel
	OSD Sensor Keys	Menu, Up, Down, Power
	Anti Reflective Film	N/A
	Screen Protection, glass	AG 100, 1.8 mm
	Security slot	N/A
	Ground bolt	Potential equalization bolt
Compliance	EU	CE(EN 55032/EN 55024/ EN 61000-3-2/EN 61000-3-3)
	Warranty	DOA
Standard		Two (2) years

Order no. Monitor

Part no.	Item
VLG24006GTF	Monitor with protective glass, without base unit

Order no. Accessories

Order no.	Item
XAVL24012	Desktop Base unit
XAVLG98424	Mounting frame
XAVL98202	Multi attachment Wide, robust mounting solution for marine
XAVL98501	External OSD (1 port.)
XAVL98502	External OSD (2 port.)
XAVL98504	External OSD (4 ports.)



VistaLine VLG240

VLG24006GTF

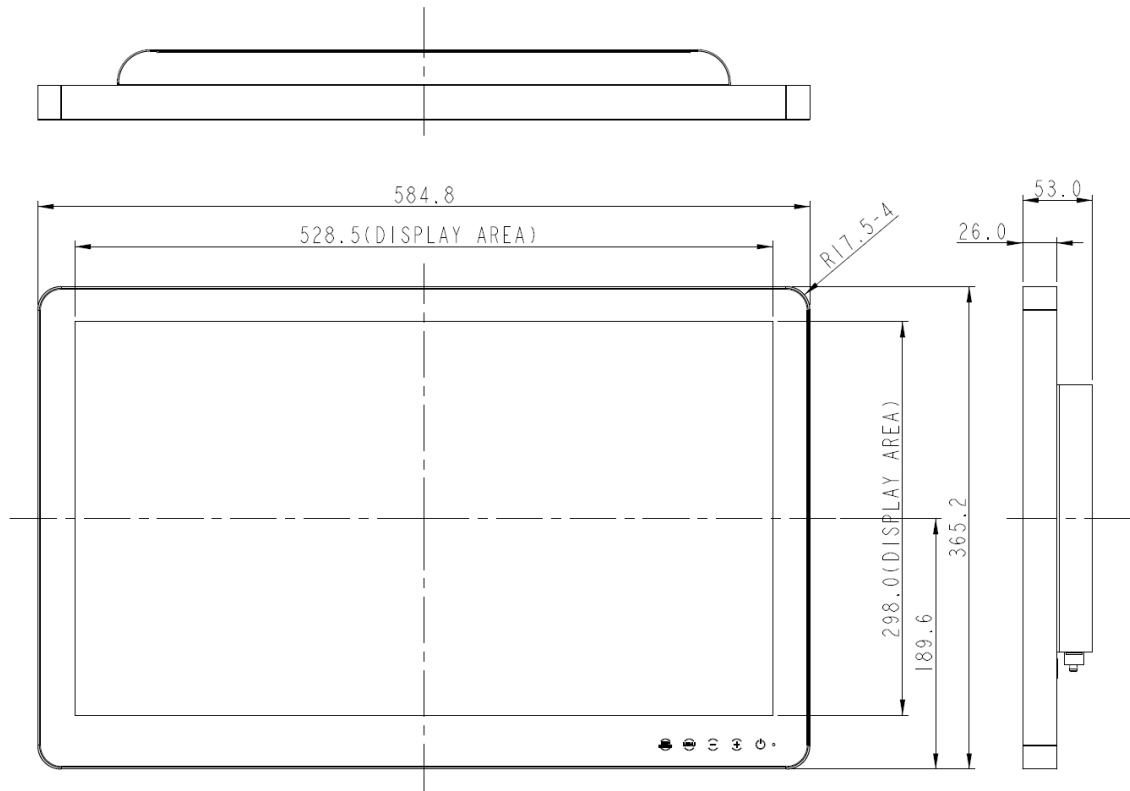

Measurements for Flush mounting frame

Order no. : **XAVLG98424**

	Outer dimensions	Cut out dimensions
Width	626 mm	594 mm
Height	406 mm	374 mm

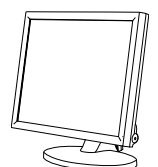
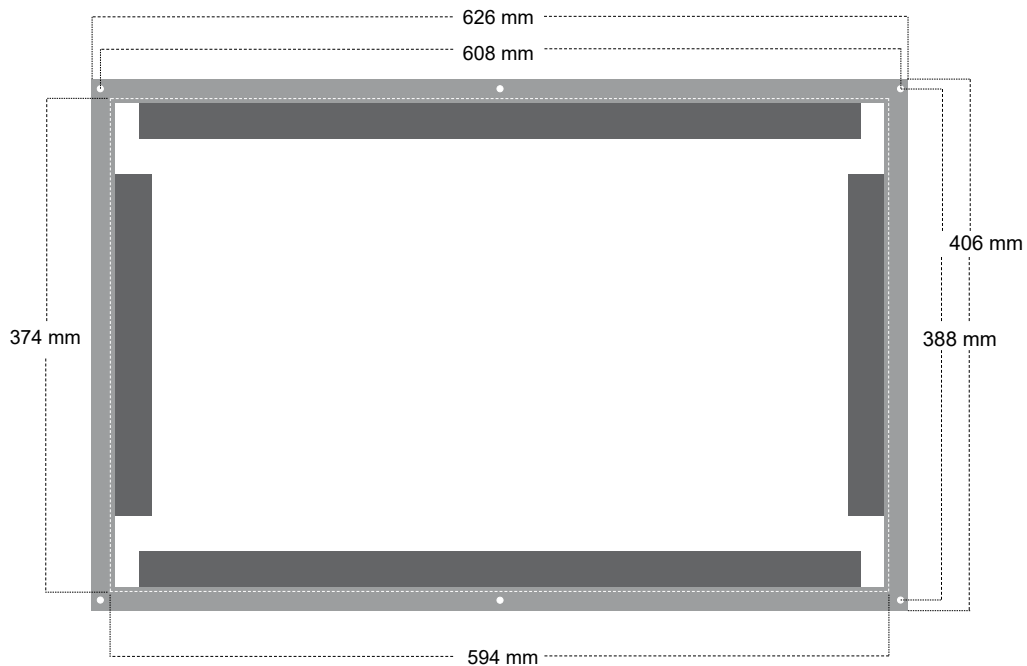



Olorin ML270G

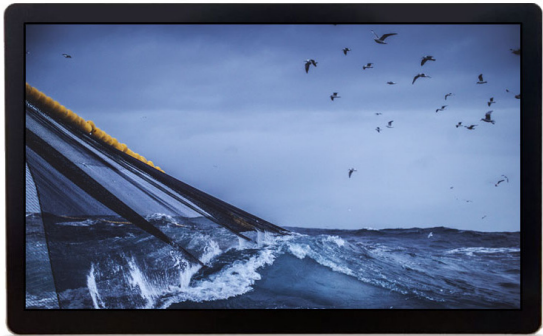

4K Ultra HD monitor with dimming

- 27" monitor with 3840 x 2160 resolution
- Dimming for night time operation
- Wide color gamut and viewing angles for optimal quality

Specification

LCD Panel	Backlight Type	WLED
	Screen Technology	AHVA
	Surface Treatment	Antiglare, Hard coating (3H)
	Screen Size, Diagonal	27.0"
	Screen Size, H/V	596.16 × 335.34 mm
	Aspect Ratio	16:9
	Resolution	3840 x 2160, UHD
	Color Depth	1.07B, 100% sRGB
	Contrast Ratio	1000 : 1 (Typ.) (TM)
	Luminance	300 cd/m ² (Typ.)
	Viewing Angles	178 / 178
	Response Time	12 ms (G to G)
	Refresh Rate	60 Hz
	Display Modes	DICOM
Gamma		1.8, 2.0, 2.2, 2.4
ITU-R Recommendation		BT.709, BT.1886, BT.2020
Temperature		Cool, Neutral, Warm, User (RGB)
Features	Automatic Luminance Control	N/A
	Dimming	Olorin Dimming, 0 to 100%
	Picture-in-Picture, PbP, PoP	PiP, PbP2, PbP3, PbP4, PoP
Video Inputs	Video Scaling	Full, Original, 1:1
	DisplayPort	DisplayPort 1.2a x 2
	DVI	DVI-I Dual Link x 4 (HDMI 1.4 Compliant)
Control Inputs	VGA	D-sub 15 pin x 1
	Serial Command, RS-232	D-sub 9 pin x 1
	Olorin External OSD	RJ45 x 1
USB	USB Downstream	USB Type A x 2
	USB Upstream	USB Type B x 1

Olorin ML270G is designed for specialists, with its high resolution 4K display and excellent color reproduction it is suitable for demanding applications, such as on the bridge of a fishing vessel.

Excellent image quality

Olorin ML270G features a standard 4K UHD resolution suitable for working environments. The monitor's wide viewing angles makes it easier for multiple operators to see the same image without distortions and its deep color reproduction should satisfy any professional.

Dimming

The monitor features a dimmable backlight, to make sure the operator can work even in complete darkness on the sea without having the monitor's contrast be compromised.

Connectivity

Olorin ML270G's has multiple video inputs for users who want to get the most out of their monitor. The monitor supports 4x DVI, 2x DisplayPort and 1x VGA.

Picture-in-Picture, Picture-by-Picture and Picture-on-Picture is supported so that you can show multiple sources at the same time. For easy operation, you can use a one button solution to switch between different inputs and PiP modes. If you have multiple uses for the monitor, you can also save different profiles to its memory and quickly load for a variety of applications.

The monitor also supports Olorin's External OSD for remote control.

Power	Power Input Type	External adapter
	Power Input Rating	100-240Vac, 50-60Hz, 1.75-0.78A
	Adapter Power Output Rating	24V 3.75A
	Power consumption	Full Brightness: 70 W Power Saving: 10 W
Mechanical	Dimensions without Base Unit	659.6mm x 408.15mm x 73mm
	Weight without Base Unit	9 (Approx) Kgs
	Housing Color	Black
	Housing Material	Aluminum
	IP Rating	
	Mounting Standard, VESA	100 x 100 mm
	OSD Interface	Sensor Keys on Front Bezel
	Anti Reflective Film	N/A
	Screen Protection	AG 80, 1.8 mm
	Security slot	N/A
Compliance	Ground bolt	Potential equalization bolt
	EU	CE (EN60601-1:2006 + A11:2011 + A1:2013, EN60601-1-2:2015)
Warranty	DOA	Three (3) months, max. 500 h.
	Standard	Two (2) years

Order no. Monitor

Part no.	Item
ML27026D	Monitor, w/o base unit

Order no. Accessories

Order no.	Item
XAVL24012	Desktop base unit
XAVL98202	Multi attachment, Wide
XAVL98501	External OSD (1 port)
XAVL98502	External OSD (2 ports)
XAVL98504	External OSD (4 ports)



Olorin ML270G

Measurements

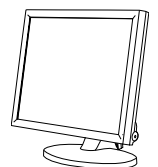
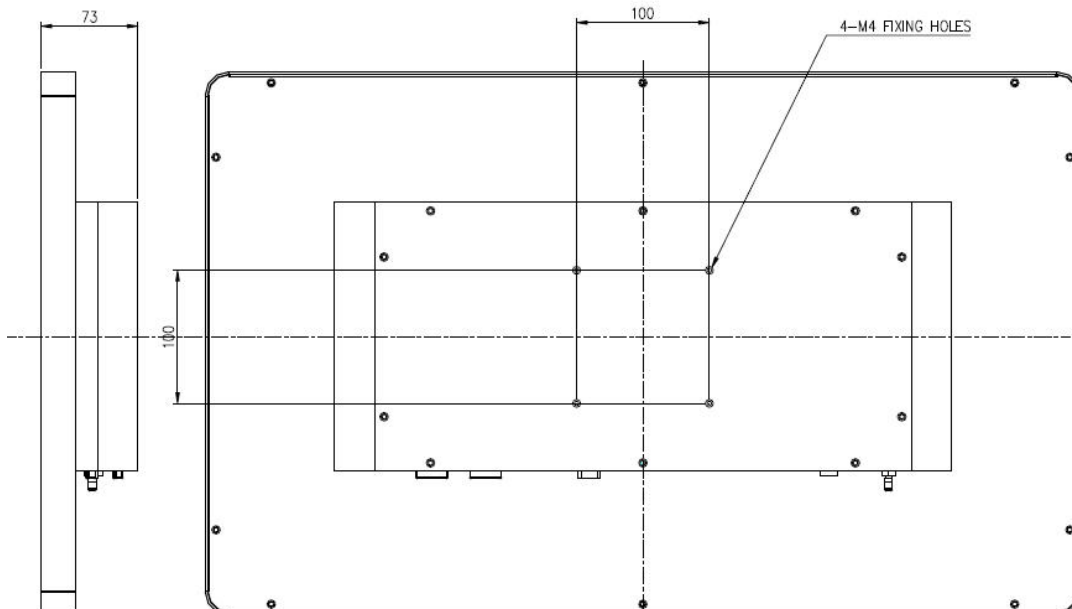
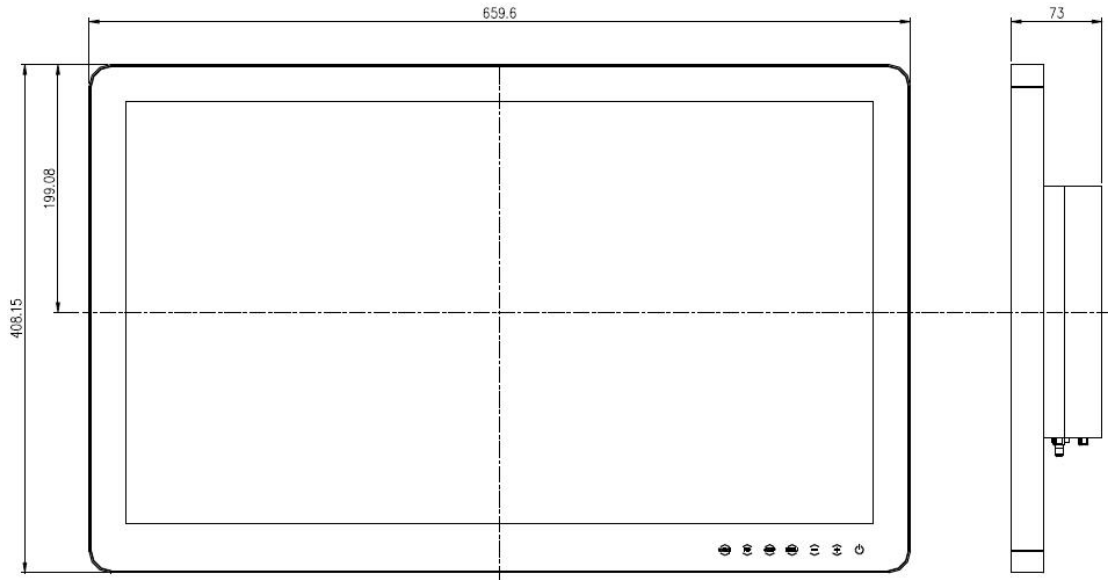



Olorin ML550G



4K Ultra HD monitor with dimming

- 55" monitor with 3840 x 2160 resolution
- Dimming for night time operation
- Wide color gamut and viewing angles for optimal quality

Specification

LCD Panel	Backlight Type	
	Screen Technology	
	Surface Treatment	Antiglare (Haze 2%)
	Screen Size, Diagonal	55.0"
	Screen Size, H/V	1209.6 × 680.4 mm
	Aspect Ratio	16:9
	Resolution	3840 x 2160, UHD
	Color Depth	1.07B, 72% sRGB
	Contrast Ratio	4000 : 1 (Typ.) (TM)
	Luminance	450 cd/m ² (Typ.)
	Viewing Angles	178 / 178
	Response Time	8.5 ms (G to G)
	Refresh Rate	60 Hz
	Display Modes	DICOM
Gamma		1.8, 2.0, 2.2, 2.4
ITU-R Recommendation		BT.709, BT.1886, BT.2020
Features	Temperature	Cool, Neutral, Warm, User (RGB)
	Dimming	Olorin Dimming, 0 to 100%
	Picture-in-Picture, PBP, PoP	PiP, PbP2, PbP3, PbP4, PoP
	Video Scaling	Full, Original, 1:1
Video Inputs	Zoom	Yes
	DisplayPort	DisplayPort 1.2a x 2
	DVI	DVI-I Dual Link x 4 (HDMI 1.4 Compliant)
Control Inputs	VGA	D-sub 15 pin x 1
	Serial Command, RS-232	D-sub 9 pin x 1
USB	Olorin External OSD	RJ45 x 1
	USB Downstream	USB Type A x 2
	USB Upstream	USB Type B x 1

Olorin ML550G is designed for specialists, with its high resolution 4K display and excellent color reproduction it is suitable for demanding applications, such as on the bridge of a fishing vessel.

Excellent image quality

Olorin ML550G features a standard 4K UHD resolution suitable for working environments. The monitor's wide viewing angles makes it easier for multiple operators to see the same image without distortions and its deep color reproduction should satisfy any professional.

Dimming

The monitor features a dimmable backlight, to make sure the operator can work even in complete darkness on the sea without having the monitor's contrast be compromised.

Connectivity

Olorin ML550G has multiple video inputs for users who want to get the most out of their monitor. The monitor supports 4x DVI, 2x DisplayPort and 1x VGA.

Picture-in-Picture, Picture-by-Picture and Picture-on-Picture is supported so that you can show multiple sources at the same time. For easy operation, you can use a one button solution to switch between different inputs and PiP modes. If you have multiple uses for the monitor, you can also save different profiles to its memory and quickly load for a variety of applications.

The monitor also supports RS232 and Olorin's External OSD for remote control.

Power	Power Input Type	Internal
	Power Input Rating	100~250Vac, 60/50Hz Universal
	Power consumption	Full Brightness: 160 W Power Saving: 20 W
Mechanical	Dimensions without Base Unit	1314.5 x 784.8 x 85 mm
	Weight without Base Unit	39.7 Kgs
	Housing Color	Black
	Housing Material	Aluminum
	IP Rating	IP 65 (Front bezel only)
	Mounting Standard, VESA	400 x 200 mm
	OSD Interface	Sensor Keys on Front Bezel
	OSD Sensor Keys	Source, PiP, Swap, Menu, Up, Down, Power
	Anti Reflective Film	N/A
	Screen Protection	AG 80, 5 mm
Compliance	Security slot	
	Ground bolt	Potential equalization bolt
	EU	CE (EN60601-1 /EN60601-1-2 4th)
Warranty	DOA	Three (3) months, max. 500 h.
	Standard	Two (2) years

Order no. Monitor

Part no.	Item
ML55026D	Monitor

Order no. Accessories

Order no.	Item
XAVL98501	External OSD (1 port)
XAVL98502	External OSD (2 ports)
XAVL98504	External OSD (4 ports)

Furuno Smart Bridge with Olorin monitors!



Smart Bridge

Smart Bridge is a complete bridge control and video presentation system. **Furuno Sverige AB** designed the system together with experienced skippers in order to achieve the most user friendly and flexible system.

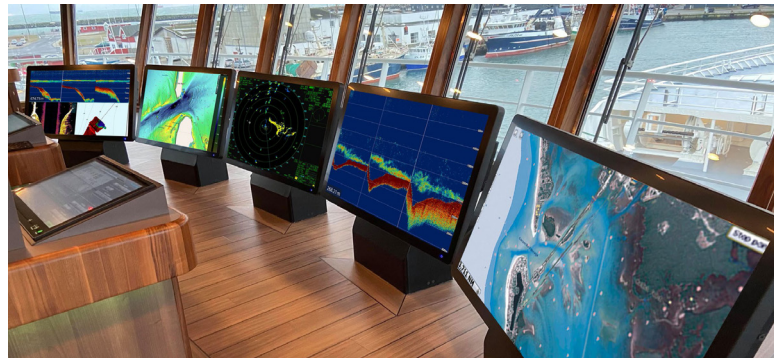

Olorin monitors

Get complete and detailed overview of all fishfinding, navigation- and work activities with **multiple large Olorin monitors**, customized to display all the information you need.

Suitable for everyone

Smart Bridge is designed for large yachts, fishing vessels, work boats and other boats that need to present video and data from several different sources on board, such as radars, ECDIS, chart plotters, echo sounders, sonars, CCTV camera systems, alarm- and control systems and so forth.





International

Olorin products are shipped worldwide, we have installations in Shanghai, Sydney, Caracas and Dubai to name a few far-away places. The main market is Europe, and in particular the Nordic countries.

Olorin AB's head office is located in Kungsbacka, Sweden.

Sales, service and support are handled by selected distributors and partners outside of Sweden.

Distributor

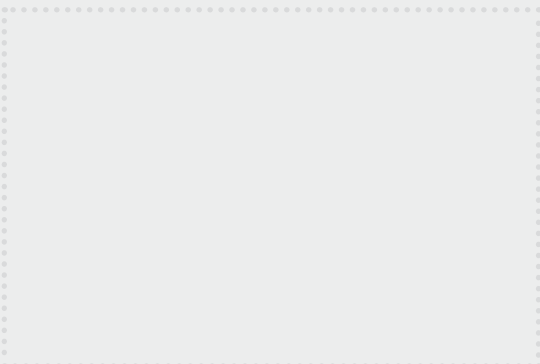

Olorin AB

Olorin is a Swedish company est. 2000 that is specialized in monitors for special application areas. We have extensive experience and knowledge of their unique work environments. Our focus is on high quality, continuous product development and excellent customer service.

Each of our product categories are specific to different applications which demand a unique set of features, both in performance and design. One common denominator is quality, which is reflected both in our choice of components and supplier but not least in our continuous product development.

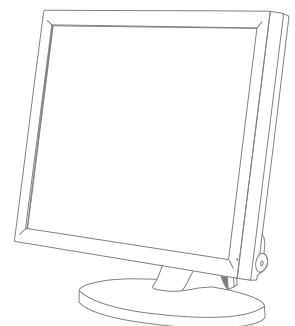

The Monitor Specialist