

ComNav[®]

marine Ltd

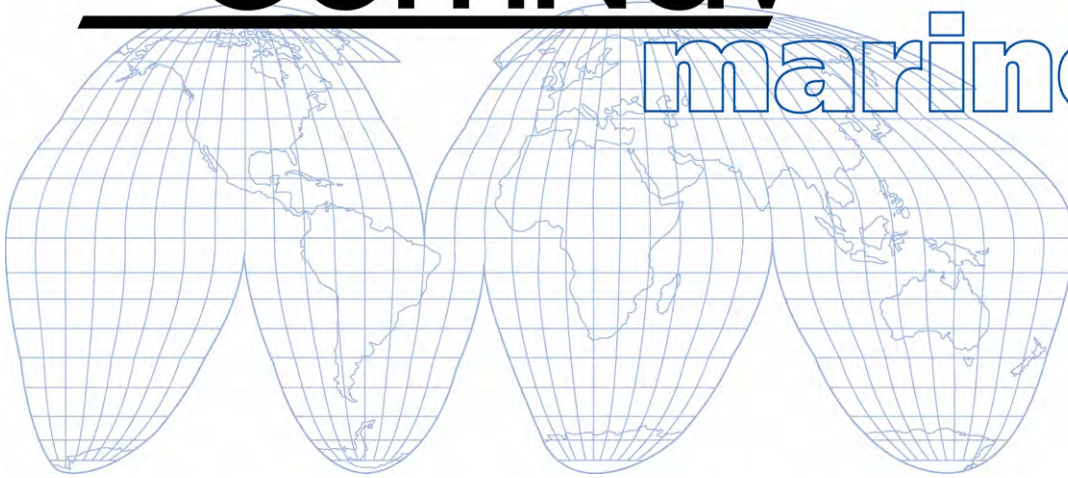

ComNav P4 Autopilot *Advanced Autopilot Systems*

Installation and Operation Manual



ISO 9001

PN 29010100

Welcome

Congratulations on your purchase of a ComNav Marine P4 Advanced Autopilot System. Developed using ComNav's many years of experience in autopilot design, the P4 Autopilot provides superior performance and advanced features, meeting or exceeding any other products in their class.

At ComNav, we are proud of our cutting-edge design and market-leading manufacture of marine autopilot systems. Our dedication to performance and reliability will ensure your satisfaction with your ComNav product for years to come.

ComNav Marine Ltd.

#15 – 13511 Crestwood Place Richmond, B.C. V6V 2G1 Canada

Tel: 604-207-1600 • Fax: 604-207-8008

Web: www.ComNav.com

E-mail: sales@comnav.com - service@comnav.com

Warranty

Prior to the installation and/or operation of any ComNav equipment, please take a moment to read and accept all warranty conditions as detailed in the Warranty Information section of this manual.

WARNING

This Autopilot is for navigation assistance only. Whenever underway, your vessel must always be under the control of a qualified and alert person who regularly and consistently ensures that the course and position of the vessel is correct and that the operating area is safe. You must always be in a position to resume manual control if the need to do so arises.

This equipment is not intended or designed to replace any person or persons on watch. A qualified individual should always be in a position to monitor the vessel's heading, and to monitor navigational hazards. The operator should always be prepared to revert to manual steering immediately if:

- ***an undesired change of heading occurs***
- ***the heading is not maintained within reasonable limits***
- ***you are navigating in a hazardous situation***

The performance of the Autopilot can be affected by many factors, including equipment failure, environmental conditions, and improper handling or use. Never place magnets or magnetic material near compasses connected to the autopilot system.

The Autopilot should never be used in areas where it is considered unsafe due to obstacles, other marine traffic, poor weather, or any other condition that could create a dangerous situation, or where it may be unlawful.

General Notice

This document, ComNav part number 29010100 Version 2 Revision 0, is the approved Installation and Operation Manual for use with the ComNav P4 Advanced Autopilot System.

Where versions of this manual exist in other languages, the English language version shall be considered authoritative.

About this Manual

This manual provides essential information for the safe and reliable operation of the ComNav P4 Advanced Autopilot System.

You are urged to read this manual in its entirety before you use your autopilot for the first time, and to keep it handy until you become thoroughly familiar with the operation of your autopilot.

Typefaces, Common Phrases and Terms

Throughout this manual, you will see a number of different typefaces used, and several commonly-used words and phrases with very specific meanings, to describe concepts and actions that are fundamental to the operation of the autopilot. Please take a moment to become familiar with the following:

- System Component
Specific system components are capitalized. Example: The Control Head
- Modes of Operation
Specific “modes of operation” are placed in bold uppercase lettering. Example: **POWER STEER** mode.
- LCD Display
Text that appears in the LCD display is in quotation marks. Example: “Waypoint Arrival”
- Button
Control Head buttons and the knob are in bold small-caps lettering. Example: the **TURN** button
- Press or momentary press
Press and release the indicated button
- Double-press
Press and release the indicated button twice in rapid succession.

Although this sounds a little complicated, it is actually very easy to do. If you use a personal computer, you will find that this is similar to a “double-click” when using a mouse.
- Press and hold
Press and hold the indicated button for approximately 1 second.
- Press and maintain
Press and hold the indicated button for as long as required to achieve a desired result.

Manual Format

This manual has been formatted to be printed on both sides of the pages, and on standard North American Letter-size paper (8.5" x 11").

If you have obtained this manual as a soft-copy, please note that it is in Adobe® Portable Document Format ("pdf"), and so may be viewed and printed with Adobe Reader®, or compatible pdf-format viewers.

When printing this manual with Adobe Reader®, you should select "duplex printing" (or the equivalent term used by your printer's software), in order to print it double-sided on the paper. If your printer does not have built-in duplexing capability, you can still print this manual double-sided by following the instructions that came with your printer for doing "hand duplexing".

You should also select the Auto-Rotate and Centre option in the Print Dialog box, de-select the Choose Paper Source by PDF page size option, and set Page Scaling to None (Adobe Reader's default setting is Shrink to Printable Area, which is printer-dependent, and usually ~97% – but no such shrinking is needed for this manual).

Document History

Revision:	Date:	By:	Description:
1R0	November 2018		First Release
2R0	June 2019		Second Release

Table of Contents

Installation and Operation Manual	2
Welcome.....	3
About this Manual	3
Table of Contents	6
How Autopilots Work	16
Manual Steering	16
Basic Autopilot System	17
System Overview.....	24
P4 Control Head.....	26
Signal Processor Unit.....	27
Compasses.....	28
Rudder Followers	29
Standard Rotary Rudder Follower and Rudder Linkage.....	29
Mounting.....	29
Electrical Connections.....	30
Heavy Duty Rotary Rudder Follower	30
Other Equipment	32
Installation.....	34
Basic Requirements	36
Steering System	36
Power Supply.....	36
Special Tools.....	36
Fasteners.....	37
Signal Processor Unit.....	37
Mounting SPU.....	37
Wire Gauge, SPU	38
Connectors & Wiring Label, SPU.....	38
Wiring the SPU	40
Power Supply (J1, Batt IN)	40
Drive Box Power Supply	40
3Power Supply Extension.....	42
Input & Output Connections (J4, N2K000 & J7, RFU)	42
N2K Network (J7, NMEA2000).....	42
Rotary Rudder Follower (J4, RFU)	43
Drive Outputs (J2, Motor out & J3, Drive Out).....	43
Reversing DC Motor Hydraulic Systems (J2, Motor Out).....	43
Linear Actuators or Mechanical Rotary Drives (J2, Motor Out & J3, Drive Out)	44
Shunt-Field Reversing Motors (J2, Motor Out & J3, Drive Out)	44
Standard Four-Way Solenoid-Activated Hydraulic Valves (J2, Motor Out & J3, Drive Out)	45
Alternating Current (AC) Solenoids (J2, Motor Out & J4, RFU)	46
External Alarm Output (J2, Motor Out & J3, Drive Out).....	46
Power Failures (J1, J2 & J3)	47
Speed Mode and Timing Outputs (J12, MISC I/O)	48
Other Connections	49

Final Steps and Post-Installation Checks for SPU installation.....	50
Control Head	51
Mounting Control Head.....	51
Wiring the Control Head	52
NMEA 2000 network connection.....	52
Ethernet	52
Other equipment.....	53
Final System Installation Verification	53
Getting Started.....	54
Autopilot Operations	54
System On/Off	54
Using the Control Head – LCD Screen and Buttons.....	55
Operating Modes and Menus Continued	58
Alarm Clear	58
System Setup	59
Dockside Setup	61
Vessel Type	62
Alarm Output Port.....	63
Thrust Type	63
Drive Setup.....	65
Compass Setup	67
Sea Trials Procedures	68
Basic Operations	72
Main Menu Setup	74
Network Config Menu	78
Setup Procedures.....	82
NMEA 2000 Compass to System	84
Rotary Feedback	85
Standby Menu	86
Station Lock.....	87
Compass Source	88
Compass Cal - Compass Calibration	88
Backlight Level	88
Fishzag Time	88
Battery	88
Power Steer Mode.....	89
Power Steer Menu	89
Stdby/P.Str Limits - Power Steer Rudder Limits	90
Auto/Nav Limits.....	90
RAI Offset	90
Auto Mode	91
Seastate.....	93
Turn Rate	93
There are two Turn Rate settings; one is for low speed operations (LO) and one is for high speed operations (HI).	93
Parameter Set	93

Speed Trip Pt – Speed Trip Point 94

Speed Source 94

ALC - Automatic Leeway Correction 94

Thruster Assist / Thruster Gain 94

These two functions are only available when the parameter is not set to “None.”

Complete instructions are included with the CT7 Thruster Interface. 94

NAV Mode 95

Nav Menu 96

The Nav menu contains a number of parameters used when operating the autopilot in NAV mode.

To access the Nav menu, double-press the NAV button. 96

Nav Source 96

XTE Limit - Cross-Track Error Limit 96

WayPt. Arrival - Waypoint Arrival 96

Correction 97

XTE Sense - Cross-Track Error Sense 97

Max Correction 98

Commanded Heading Displayed 98

Correction set to CTS – Steering a Direct Bearing 98

Correction set to XTE – Cross-Track Error Steering 99

Correction set to Both – Steering To/Along a Track 101

*Refer to the Navigation System’s manual for signal quality measurements,
and ideas on making improvements.*

Alternate Navigation Display..... 103

Dodge 103

Advanced Operations 108

Advanced Operations 110

WORK Mode 110

Automatic WORK Mode 112

Manual WORK Mode 112

Work Menu 113

The states shown are “Off”, “A_On” and “A_Rdy” (abbreviations for Automatic On and Automatic Ready, respectively), or “M_On” and “M_Rdy” (Manual On and Manual Ready). 113

Special Turns & Turn Menu 115

U-Turn..... 116

Circle Turn 117

Fishzag 119

Station Lock/Unlock 121

Care and Maintenance 108

Cleaning and Appearance 124

Protection of Wires and Cabling 124

Periodic Checks..... 124

Fuse Replacement..... 125

Appendices	126
Appendix 1	128
NMEA 0183 Heading Sources	128
Appendix 2	129
Non-NMEA 2000 Product Support	129
Appendix 3	144
Error Messages	144
Appendix 4	147
Diagnostic LEDS.....	147
Appendix 5	148
Upgrading Firmware	148
Appendix 6	149
General Specifications.....	149
Appendix 7	150
Compass Safe Distances	150
CE Compliance (European Conformity).....	151
Warranty Information	152
User Notes and Settings	156
User Settings	158

List of Figures

Figure 1 – Basic Autopilot System	17
Figure 2 – Heading Change in AUTO Mode	20
Figure 3 – P4 System Block Diagram	26
Figure 4 – Control Head	27
Figure 5 – The P4 SPU with Wiring and Diagnostic Covers Removed	28
Figure 6 – G2 GPS Compass	29
Figure 7 – Rotary Rudder Follower	30
Figure 8 – Rudder Follower Linkage Geometry	31
Figure 9 – Heavy Duty Rotary Rudder Follower	32
Figure 10a – SPU Plug Wiring Details	39
Figure 10b – SPU Connector Details	40
Figure 11 – Typical Battery Connection to SPU	41
Figure 12 – Reducing Supply Voltage Losses	42
Figure 13 – Wiring Connections for P4 SPU to N2000 Networks	42
Figure 14 – Wiring Connections for Rudder Followers	43
Figure 15 – Wiring Connections for Reversing DC Motors	43
Figure 16 – Wiring Connections for Linear Actuators or Mechanical Rotary Drives	44
Figure 17 – Wiring Connections for Shunt Field Reversing Motors	44
Figure 18 – Wiring Connections for Standard Four-Way Solenoid Valves	45
Figure 19 – Wiring Connections for Constant Running Electric Pump	45
Figure 20 – Wiring Connections for A.C. Solenoids	46
Figure 21 – External Alarm, using SW'D B- Output	46
Figure 22 – External Alarm, using SW'D B+ Output	47
Figure 23 – External Alarm, SW'D B- Output – with Power Fail Option	47
Figure 24 – External Alarm, SW'D B+ Output – with Power Fail Option	48
Figure 25 – Thruster Signals for SPU-T	50
Figure 26 – P4 Control Head – Rear View	51
Figure 27 – Battery Connection to Master P4 Head	52
Figure 28 – Introductory Display	55
Figure 29 – Using the Control Head	55
Figure 30 – A Typical Menu	58
Figure 31 – Autopilot in Standby Mode	59
Figure 32 – Data Sources used by P4 Autopilot	59
Figure 33 – Set Vessel Type	64
Figure 34 – Set Compass Type in Compass Configuration Menu	67
Figure 35 – System Menu Tree	74
Figure 36 – System Menu Screenshot	74
Figure 37 – Network Configure Menu	78
Figure 38 – Dockside Menu Enter from System Menu	81
Figure 39 – P4 System Setup	82
Figure 40 – Standby Menu	86
Figure 41 – Typical Power Steer Mode Screen	89
Figure 42 – Power Steer Menu	89
Figure 43 – Typical Auto Mode Screen	91
Figure 44 – Typical Auto Menu Screen	92
Figure 45 – Guidelines for setting Counter Rudder	93
Figure 46 – HI and LO Speed Icons (Left of Rudder Angle Indicator)	94
Figure 47 – Typical NAV Mode Screen (Normal Display)	95

Figure 48 – Nav Menu	96
Figure 49 – Steering with Correction set to CTS	98
Figure 50 – Steering with Correction set to XTE	100
Figure 51 – Response of Vessel to a Large Cross-Track Error	101
Figure 52 – Steering with Correction set to Both	102
Figure 53 – Typical NAV Mode Screen (Alternate Display)	103
Figure 54 – A Dodge in Progress (in AUTO Mode)	104
Figure 55 – Vessel Track During a Dodge Manoeuvre in AUTO Mode	104
Figure 56 – Typical Jog Lever Activated Screen	105
Figure 57 – Typical WORK Mode Screen (Engaged)	111
Figure 58 – Work Mode Menu	113
Figure 59 – Typical Special Turn Query	115
Figure 60 – U-Turn Query	116
Figure 61 – U-Turn Vessel Path	116
Figure 62 – Circle Turn Query	117
Figure 63 – Circle Turn Vessel Path	117
Figure 64 – M.O.B. Turn Query	118
Figure 65 – M.O.B. Turn Vessel Path	118
Figure 66 – Fishzag Turn Query	119
Figure 67 – Fishzag Turn	119
Figure 68 – Turn Menu Screen	120
Figure 69 – Station Lock Icons on the screen	121
Figure 70 – NMEA 0183 / NMEA 2000 system	128
Figure 71 – GNSS G2 GPS Compass	129
Figure 72 – Typical NMEA 0183 Connections	129
Figure 73 – Fluxgate Compass	131
Figure 74 – Wiring Connections for Analog Compasses	131
Figure 75 – Externally Gimballed Magnetic Compass with Magnetic Sensor	132
Figure 76 – CR-203 Handheld Remote	134
Figure 77 – TS-203 Fixed Remote	135
Figure 78 – Wiring Connections for Control Head, Handheld and Fixed Remotes	136
Figure 79 – Jog Lever	137
Figure 80 – Wiring Connections for Jog Levers	137
Figure 81 – External Rudder Angle Indicator – 3” Model	139
Figure 82 – Wiring Connections for rudder Angle Indicators	139

List of Tables

Table 1 – Minimum Recommended Wire Gauges	38
Table 2 – Speed Mode and Timing Outputs	49
Table 3 – Turning Off P4 System.....	54
Table 4 – Vessel Type	62
Table 5 – Nav Mode Correction	97
Table 6 – NMEA 0183 Sentences Accepted by the P4	141
Table 7 – NMEA Sentence Priority	142
Table 8 – Warning Messages	144
Table 9 – Error Messages.....	145
Table 10 – Critical Error Messages.....	146
Table 11 – Diagnostic LEDs	147
Table 12 – General Specifications	149
Table 13 – Compass Safe Distances.....	150
Table 14 – User Settings	158

Introduction

How Autopilots Work

The purpose of this introductory section is to briefly describe what an autopilot does and some of the things you should expect when using an autopilot with your boat.

Manual Steering

Every vessel has unique dynamics, which depend on its design, shape and dimensions, as well as current speed, loading, and sea conditions. The net result is that every boat (or rather, every unique boat *design*) “steers” in a unique way.

To understand what an autopilot does when it is steering your vessel, it is helpful to think for a moment about steering a boat by hand.

When you are holding the boat on a given Heading, you know from instinct and experience how much rudder to apply, and how fast to apply it, to keep the boat on-course. Corrections are usually just a small, quick movement of the helm to one side, then back to the dead-ahead position.

- You won't always try to correct when the boat rolls or accelerates off a wave, especially in heavy seas – because when the boat rolls back the other direction, it will usually come right back on-course.

Instead, your experience reminds you to allow the boat to yaw those necessary degrees on either side of the Heading, to reduce the fight.

- To turn the boat to a new Heading, instinct and experience again remind you how much rudder to use, and how fast, to get the boat turning at your normal rate of steer.

If the boat is not turning as rapidly as you want (for example, with a cross- or cross-current holding back the bow), you slightly increase the amount of rudder.

On the other hand, if the boat is turning too fast, you reduce the applied rudder a bit. You then gradually reduce the applied rudder, as the boat approaches the desired Heading.

You might even put the helm over opposite for a moment, to stop the boat swing more quickly – in order to come to the desired Heading without overshoot.

The single most basic purpose of an autopilot is to control the vessel the same as a human operator would ... to let the boat “work with the seas”, yet still maintain as straight a Track as possible in the current conditions, on the desired Heading or Course.

The P4 Autopilot System uses the latest generation of ComNav's carefully-designed, well-proven steering control algorithms, which are based on many years of designing and manufacturing autopilots.

There are a number of parameters used in the steering algorithms, collectively referred to as “Steering Parameters.” The P4 Autopilot system has been tested on a wide variety of boats, of different types and sizes. The default settings for the Steering Parameters are average values derived from that testing, and provide a good starting place for most boats.

During sea trials, and later on normal operation, you may want to adjust some of those values, so that they better match your boat's unique design dynamics.

However, the information in this section can be applied in general to any ComNav autopilot, and is not necessarily specific to the P-Series.

Basic Autopilot System

Figure 1 is a block diagram of the major components of an autopilot system.

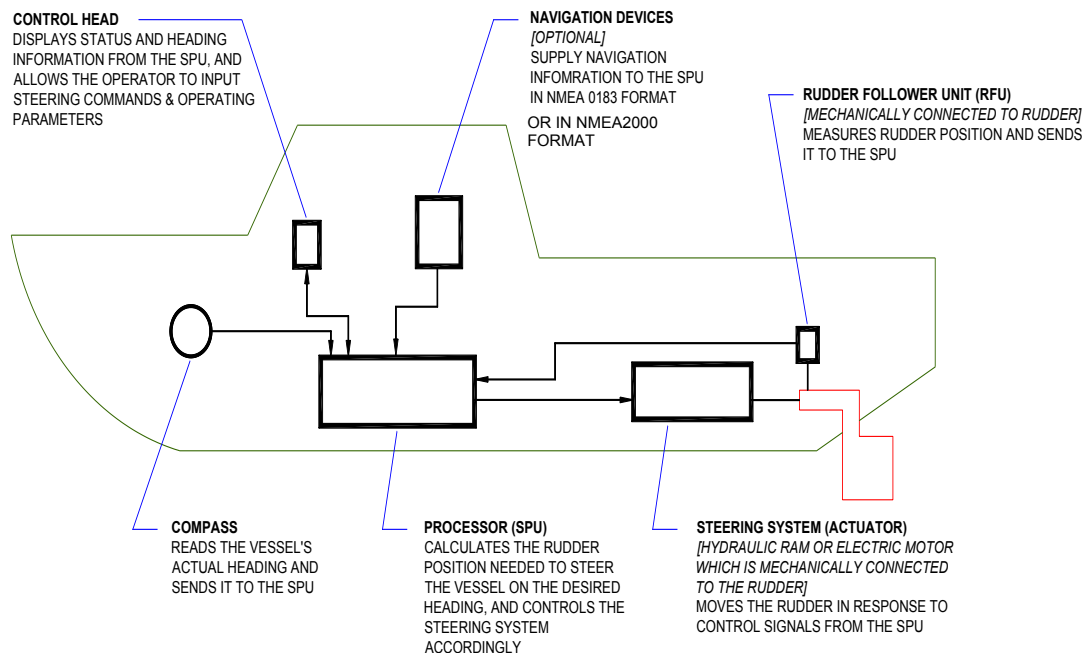

Figure 1 – Basic Autopilot System

The Compass indicates the direction in which the boat is pointed, often referred to as the Actual Heading. Depending on the type of boat and installed equipment, the Compass may be a magnetic compass, an electronic fluxgate compass, a gyroscopic compass, or a GPS Compass.

- A reliable compass is absolutely vital to the autopilot; without a trusted compass, the autopilot has no way of knowing where the boat is, or which way it is headed.

The actual heading is fed electronically from the Compass to the Signal Processor Unit (SPU), which is the heart of the autopilot. The SPU contains the microcontroller(s), electronic hardware, and the sophisticated control software necessary to steer the boat on any *desired Heading*.

The Control Head, normally located in the wheelhouse, is the interface between the vessel's operator and the autopilot. The Control Head displays information about what the autopilot is doing, and it has various controls (buttons and/or knobs) that allow you to give commands to the autopilot.

The final part of the picture is the Steering System. In order for the autopilot to steer the boat, there must be a steering system capable of moving the rudder independently of the ship's helm. This might be a hydraulic ram that is connected to the rudder post or tiller quadrant, or an electric motor connected to the steering cables.

However, no matter what type of steering system the boat uses, electronic signals from the SPU tell the system to move the rudder, when needed – how far and in which direction.

Your autopilot also have a Rudder Follower Unit (also called a Rudder Feedback Unit, or just “RFU”), a device that tells the SPU what position the rudder is in at any given time.

Autopilot Operation

Maintaining a Heading: **AUTO** Mode

With a ComNav Autopilot, following a Track or Course that you want to be on is very simple:

- Set the autopilot into **AUTO** mode.
- Using the Control Head, input the Heading you want the autopilot to follow.
- The autopilot then moves the rudder (as required) to initiate and keep the vessel on that Heading ... just like you would if you were steering manually.

Here's how it works:

The steering control algorithms running in the firmware on the SPU's microcomputer are constantly comparing – multiple times per second – the boat's actual Heading (as indicated by the Compass) to the desired Heading you have input.

If there is a difference, the algorithms then calculate how much to move the rudder, to bring the boat back onto the desired Heading. The amount of corrective rudder movement is based on:

- How much the Headings differ.
- How long there has been a difference and by how much.
- How rapidly the difference is changing.

Here is an example which illustrates how the autopilot maintains a Heading in **AUTO** mode. Imagine the boat is a few degrees off-course to Port:

- The SPU will signal the steering system to move the rudder to Starboard, by a few degrees.
How many degrees the rudder moves depends on the type of vessel, and its dynamics (which you have specified and tested when you set up the autopilot).
***Note:** On a P4 Autopilot with an RFU, the SPU verifies that the rudder has moved, by reading its position from the RFU.*
- The boat begins to turn to Starboard.
- As the boat turns, the difference between the desired and actual Heading gets smaller, and as it does, the SPU then starts to ‘back off’ the rudder – i.e., move it back to centre – so that the boat does not overshoot the desired Heading.

- If the boat isn't coming back on-course very quickly, the SPU's algorithms will not back the rudder off right away, and might even move the rudder a bit farther to Starboard for a while.
- On the other hand, if the boat is coming back too quickly, the rudder will be moved quickly back to dead-ahead – or maybe even a bit to Port for a few seconds.
- Eventually, the actual Heading will match the desired Heading.
- If-and-when the boat falls off-course again, the same sequence will be repeated.

In summary, this is all very similar to steering the vessel manually, it's just happening multiple times per second, much more precisely and rapidly than a human could – and without the lapse in focus sometimes attributed to a human operator.

Changing Heading

Heading changes are very simple with a ComNav autopilot as well. Imagine for example, that the autopilot is steering your boat Southwest, and you now wish to change direction to Southeast (see [Figure 2](#)).

To initiate the turn in **AUTO** mode, you would simply turn the knob on the Control Head to set the desired Heading (as shown on the Control Head's display screen) to 135° ... Southeast.

After that, the autopilot behaves much the same as when maintaining a Heading – but with an initially large “Heading error” (90° to Starboard, in this example) that must be dealt with:

- When the SPU moves the Rudder to Port, it will probably be by quite a bit, maybe even all the way to the stops – but not immediately so the boat doesn't turn too rapidly.
- Eventually, the actual Heading will match the desired Heading ... and the boat will then be going Southeast.
- The SPU will keep steering the boat on the new 135° Heading, and maintaining that Heading until another Heading is selected.

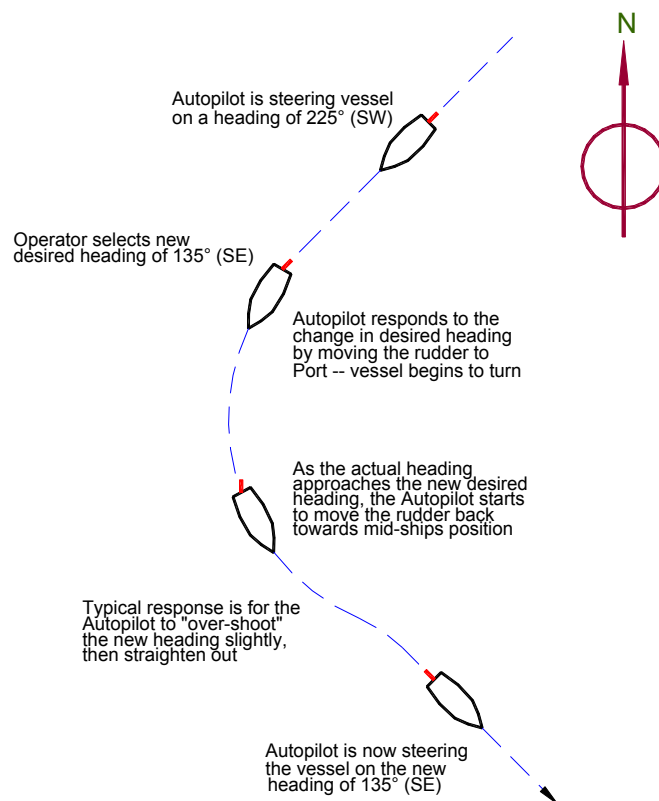

Figure 2 – Heading Change in AUTO Mode

Wind and Current Effects

If your vessel encounters a crosswind, and/or a tidal current at any given angle to the desired Heading, it will be pushed away, in the direction of the wind or current. At this point, the autopilot will constantly be making Heading corrections with the rudder, as it tries to maintain your desired Heading.

If that condition persists, the SPU will gradually begin to alter the rudder a few degrees to Port or Starboard of the centred position, to counter the effect of the wind and/or current. This feature, known as *Automatic Rudder Trim*, will keep your boat pointed in the right direction, despite the wind or current.

However, one side-effect of Auto-Trim is that your boat may not follow the Track you want; it will maintain your desired Heading, but the Track may “slip” sideways in the direction of the crosswind and/or current. This potential problem can be solved by using another mode that ComNav Autopilots provide, which is the NAV mode.

Following a Track: NAV Mode

So far, we have seen how an autopilot operates in AUTO mode, whereas a new desired Heading must be selected on the Control Head each time you wish to change direction. This is useful for short trips or when you know the direct course to your destination.

But for longer trips, which often involve a number of “legs” at different headings, it would be useful to be able to have your autopilot steer your boat along all the legs, in sequence.

ComNav autopilots allow you to do just that, with NAV mode.

The autopilot must be connected to an external source of navigation information (commands and data), such as a chart plotter, or a Navigation program running on a PC. A source of position data is also required, it may be built into the external Navigation System, or it may be another device or system, like a GPS receiver (such as a ComNav GPS Compass), a LORAN C receiver, etc. (all such external devices are in general referred to in this manual using the generic term *Navigation System*).

ComNav Autopilots implement the industry-standard NMEA 0183 protocol for reception and transmission of navigation information. Almost all modern Navigation System equipment complies with NMEA 0183, so interfacing with a ComNav autopilot is relatively simple.

A long voyage will consist of a series of waypoints, which are specific locations on the Earth's surface, as defined by their Latitude and Longitude. These waypoints define the route you want the boat to travel on, from your starting position to your destination. You enter them into the external Navigation System when creating the route.

The system determines the current location of the boat (from the position data source), and then calculates the course that must be steered in order to reach the next waypoint.

When the Autopilot is switched into NAV mode, it begins to look for some specific navigation information from the Navigation System: the course to steer to the next waypoint, and the Cross-Track Error (which is the distance from the boat to the desired Track, from the last waypoint to the next one). Using these two pieces of information, the autopilot steers the boat on the shortest possible Track to the next waypoint.

Cross and/or currents are compensated for automatically each time the Navigation System updates the Cross-Track Error. This is why **NAV** mode is the answer to the “track slip” problem that can occur in **AUTO** mode, when a cross/current exists.

When a waypoint is reached, the Navigation System sends the SPU the next set of navigation information – for the next waypoint – and the SPU then turns the boat to head to that next waypoint.

Following a Track: AUTO/ALC Mode

Some ComNav autopilots (including the P4), provide another way to keep your boat on a specific *Track*: Automatic Leeway Correction.

This feature can be turned on in **AUTO** mode. **ALC** is similar to **NAV** mode, in that it uses NMEA0183 or NMEA2000 Latitude and Longitude data to sense if the boat is following the desired Track.

Unlike **NAV** mode, however, a ComNav autopilot with the **ALC** feature only needs Latitude and Longitude data in **AUTO/ALC** mode. It does not need Cross-Track Error data from the external Navigation System, nor to have any waypoints set in the system. The **ALC** feature calculates the Cross-Track Error on its own, using the desired Heading active at the point in time when **AUTO/ALC** mode is first engaged.

Power Steer: “Drive by Wire”

Most ComNav autopilots have a **POWER STEER** mode, which provides a way for the user to control the rudder directly. In effect, the autopilot acts as a sort of “electronic steering wheel”, allowing the operator to steer the boat manually, in a similar way as when using a standard manual steering wheel or tiller – but instead steering the boat with the autopilot’s Control Head, or any remote controls it is equipped with.

Steering, when using the autopilot in this mode, is done with two buttons and/or a knob on the Control Head. Button 1 and/or a clockwise turn of the knob, will move the rudder to Starboard, causing the boat to turn that way; the other button, and/or a counter-clockwise turn of the knob, will move the rudder to Port so that the boat turns that way.

Using the buttons/knob, the rudder can be placed in any desired position where it will remain. This feature is useful when docking or manoeuvring, because the person steering the boat can take their hands off the controls between rudder movements.

Additional Technical Information

Mathematically, the autopilot’s steering algorithms are based on a control method known as a “PID Loop” ... an acronym for a “Proportional, Integral, Derivative” error-correction technique.

The amount of rudder movement to correct for any Heading error (or to make a turn), is continuously re-computed, in a processing loop, as a value that is:

- Proportional to the error (or how much more of the turn is still to be done).
- An Integral of the error/turn ... how big for how long.
- A Derivative of the error/turn ... how fast it is changing.

Many references can be found on PID Loops, on the internet and elsewhere, if you want to know more. ComNav also occasionally holds training seminars – check with your dealer for more information.

System Overview

System Overview

This chapter provides a brief description of the major elements of the P4 Advanced Autopilot System, its functions, and their relationships to each other.

Figure 3 shows a block diagram of a typical example of the P4 electronics only system, showing the interconnections between the elements of the system. Steering Drive systems such as DC reversing pump, DC/AC solenoids hydro-electro actuators for the rest of the steering system:

- The Main Control Head
- The Signal Processor Unit (SPU)
- A Compass or other Heading Sensor
- The Rudder Feedback Unit

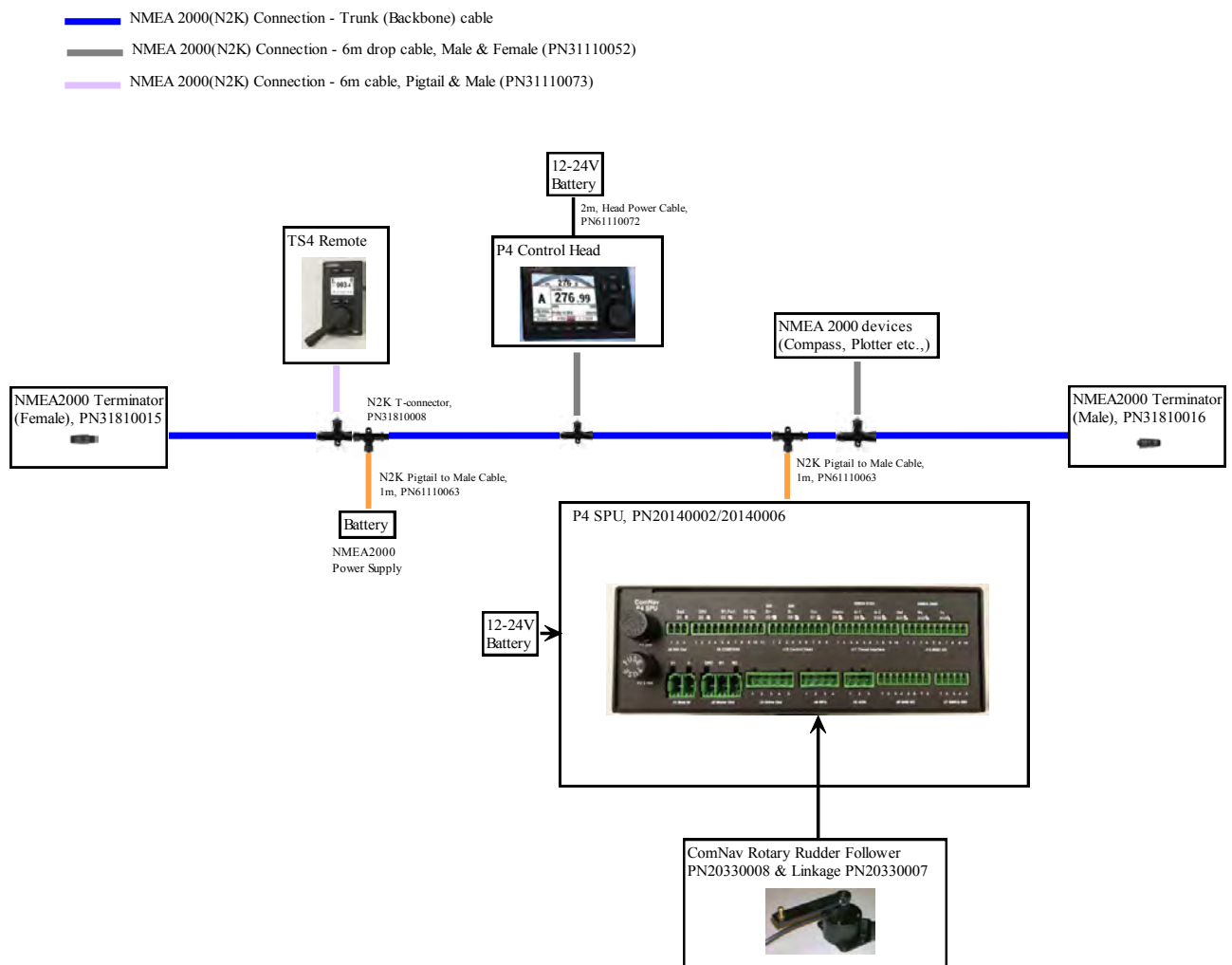

Figure 3 – P4 System Block Diagram

Control Head

PN 20140001 (P4 Second Station Kit, Colour Head)

PN 30140001 (P4 Colour Head only)

The P4 Control Head (**Figure 4**) connects to a Signal Processor Unit (SPU) via NMEA 2000 NETWORK/CAN-bus through 6m NMEA 2000 standard light cables included with the units.

Note if you are not connecting the autopilot to an existing working NMEA 2000 network, you should make sure the CAN-bus is terminated at the two ends of its back bone. A working NMEA 2000 will have terminators installed properly.

P4 Control Head incorporates a state-of-the-art, high visibility/high resolution VGA colour LCD display.



Figure 4 - Control Head

The Control Head, when shipped as part of a complete P4 system, is a “core” module, with accessories for flush mounting option: Bracket(trunnion) mount kit PN 30140003 for Deck or Bulkhead mount is optional kit available. All required hardware is included., except for fasteners (mounting hardware) needed to fasten the bracket to a mounting surface.

Signal Processor Unit

PN 20140002

The Signal Processor Unit (SPU) accepts a number of inputs from the other components of the autopilot system, and then processes them as necessary to control the movement of the vessel's rudder to maintain a given heading. As well as steering the vessel, the sophisticated software within the SPU continually checks all aspects of the autopilot's performance, and will advise the user via the Control Head if any problems are encountered.

The most essential data for the SPU is the heading information and the rudder feedback signal.

The SPU can accept heading information from an NMEA 2000 device; it can also accept heading information from an analog compass port, or one of its 2 NMEA 0183 ports.

The SPU requires the rudder feedback signal sent to its analog port at J4.

There are other wiring ports that are provided for the backward compatibility to ComNav older autopilots. See appendices under Legacy products for more details.

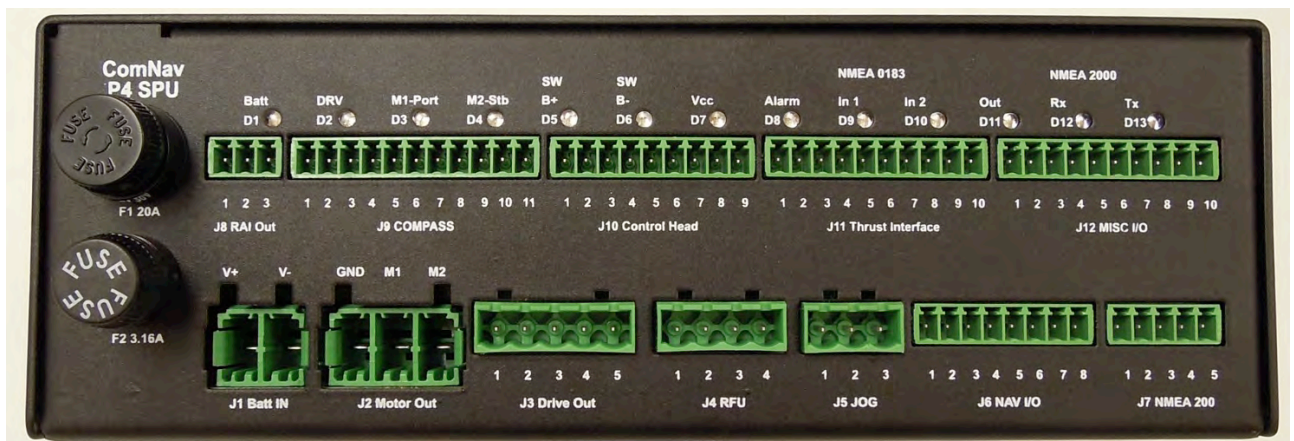

Figure 5 – The P4 Signal Processor Unit (SPU) connection panel

Compasses

The Compass is a critical component in the proper operation of the P4 Autopilot System. The autopilot system's ability to steer the vessel to a given Heading desired by the Operator can only be as accurate as the Compass.

Note: It is always a wise and safe choice to have at least two compasses, and/or other Heading sensing devices, on board.

G1 and G2 GNSS Compasses

PN 11220008 (G1) – NMEA2000 model

PN 11220006 G2 NMEA 2000 model

The ComNav GPS Compasses are state-of-the-art devices which can provide accurate 2D Heading and Position data to autopilots, sonar, chart-plotters, AIS transponders and other NMEA2000 devices.



Figure 6 – GNSS G2 GPS Compass

The GNSS NMEA2000 compass is connected to the NMEA2000 network via a 6m NMEA2000 cable.

Rudder Followers

Standard Rotary Rudder Follower and Rudder Linkage

PN 20330008 and 20330007

The ComNav P4 is normally supplied with a ComNav Medium Duty Rotary Rudder Follower.

The Rudder Follower is used to transmit the position of the vessel's rudder to the SPU. It should be connected to the part of the steering system that the autopilot controls. Normally, it would be the vessel's rudder. However, if the vessel has two-stage steering, where the autopilot drives a control or servo ram, the Rudder Follower should be mounted to the servo ram rather than the rudder.



Figure 7 – Rotary Rudder Follower

Mounting

Install the Rudder Post Arm on the rudder post using a stainless-steel band clamp (not supplied). Bolt the ball joint to the hole in the Rudder Post Arm corresponding to the diameter of the Rudder Post in inches, making sure the ball is facing upwards.

Mount the Rudder Follower so that the Rudder Follower Arm is the same height as the Rudder Post Arm. The Rudder Follower is centered when the arm is directly above the cable gland (see [Figure 8](#)).

The distance between the centerline of the Rudder Post and the Rudder Follower must not exceed 24 inches. Make sure that the ball joints on the Rudder Arm and Rudder Follower arm are facing upwards as shown.

Snap the rod assembly onto the ball joints. Be sure to close the release clamps on each socket, and then adjust the length of the rod to get the correct geometry with the rudder dead-ahead.

If the locking screw in the Rudder Follower arm has been loosened, or the arm removed from the Rudder Follower, re-attach the arm and check the potentiometer center position.

When the rudder is dead-ahead, the electrical resistance between the wires of the black and green wire pair, and the wires of the white and green wire pair, should be equal (approx. 600 ohms each).

Be careful to check the installation for any mechanical obstructions or binding of the linkage, and correct it now, before it becomes a problem.

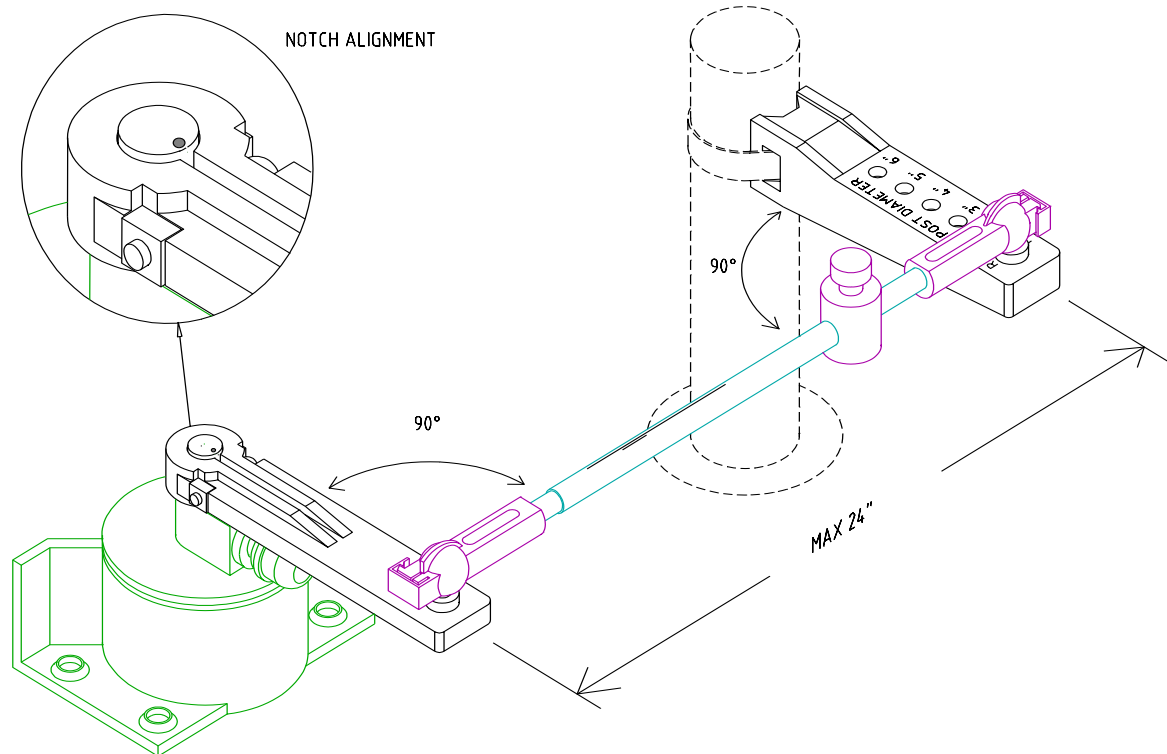

Figure 8 – Rudder Follower Linkage Geometry

Electrical Connections

The Rudder Follower is normally supplied with approximately 15.5 metres (50') of cable. Run the cable from the Rudder Follower towards the SPU, ensuring that a hose, grommet or conduit protects it wherever it passes through bulkheads, holds, or any other area where it could be damaged.

If the length of cable supplied is too short to reach all the way to the SPU, obtain a terminal strip and sufficient additional cable from your ComNav Dealer. Mount the terminal strip in a convenient and dry location where it will not be subjected to moisture of any kind.

Heavy Duty Rotary Rudder Follower

PN 20330012

A Heavy-Duty Rotary Rudder Follower is available for special applications. Check with your ComNav Dealer to determine whether this product is suitable for your application. Separate installation instructions are provided with this Rudder Follower.

See the page 43 Figure 14 for further details on connecting the cable to the SPU.

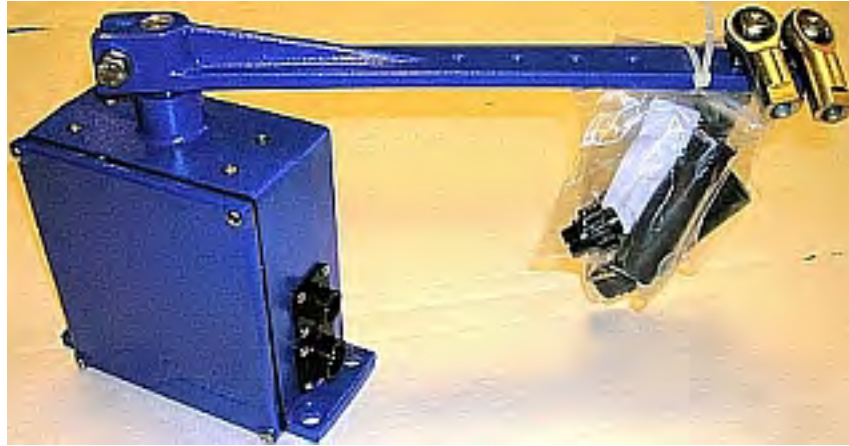

Figure 9 – Heavy Duty Rotary Rudder Follower

Other Equipment

Besides the optional equipment described above, there is a wide choice of other equipment available for use with the P4 Advanced Autopilot system see Appendices for Legacy product compatibility or contact your ComNav Dealer for information and details.

Installation

Installation

This chapter describes all the steps you must follow to physically install a P4 Autopilot System into your vessel. Each of the standard components of the system are described, both physical mounting and electrical wiring, and then some final checks are provided. Commonly-used accessories are also described. Many components come with their own specific instructions, which also require close attention.

Basic Requirements

Please refer to the Warranty Information section of this manual before proceeding with installation.

Hazard warning!

Caution! *Extreme caution is necessary whenever using tools powered by alternating current (AC), and/or from main AC supply circuits, regardless of whether the supply circuits are indoor, outdoor, ground-fault protected, marine or industrially rated. Water, especially sea water, is an excellent conductor of electricity, and can complete a path to ground through a person's body, causing injury or death, if a tool or component malfunctions or short-circuits.*

Battery powered tools are STRONGLY recommended!

If 120v AC tools are to be used, they must be plugged into a circuit that is adequately protected against ground faults and safety hazards, in accordance with local electrical codes.

THE AUTOPILOT IS INTENDED FOR SINGLE AUTOPILOT INSTALLATION ON THE NMEA2000 BUS NETWORK. FOR REDUNDANT OR MULTIPLE SPU AND RFU DATA SOURCE, INCLUDE OTHER INDUSTRY STANDARD AUTOPILOT MODULES CONNECTED TO THE NMEA2000 BUS NETWORK, CONTACT COMNAV FACTORY OR COMNAV AUTHORIZED DEALER FOR SPECIFIC APPLICATION SOFTWARE UPGRADE TO THE SYSTEM.

Steering System

To obtain the best performance from your autopilot system, your boat's steering system must be in good working order. The hydraulic system should be bled, and should operate with minimal play.

When installing a Reversing Motor Pump, a Constant Running Pump, or an Engine Driven Pump, it is **recommended** that you install shutoff valves on all hydraulic lines between the pump and the steering system.

Power Supply

For reliable operation of your Autopilot, your boat's power supply system must have a DC (direct current) power supply, with an adequate breaker and/or fuse, at a nominal voltage of either 12 or 24 volts. If the circuits are fused, a power switch should also be installed. Ensure that adequate wire sizes are used to handle the expected maximum currents.

Special Tools

A slot screwdriver with a tip size of ~2.5 mm (0.1") is required, for tightening the small screws of the wire clamps in the plugs which mate with the SPU's pin-receptacle connectors.

Fasteners

In general, fasteners are not supplied with the system – since different surfaces need various types of fasteners. However, no matter which types are best suited to your vessel, ComNav strongly recommends that you use stainless steel and/or non-corroding hardware to secure all equipment in the system.

Signal Processor Unit**Mounting SPU**

The SPU should be mounted in a clean and dry area, away from heat, moisture, and liquids of any kind. The SPU should be centrally located, and mounted far enough away from your vessel's compasses so as to minimize any possible electrical interference; a good rule-of-thumb is at least 1 metre (about 3'), but see the Appendices page 150 Table 14.

Compass Safe Distances section for specific values, if you do not have that much space. The SPU can be mounted vertically on a bulkhead or horizontally on a deck or shelf.

- If mounted vertically, it should be positioned so that all wires and cables will exit from the bottom of the SPU (after running sideways, left and/or right as appropriate, from the SPU connectors under the SPU's wiring cover) and secured to avoid accidental disconnection from the receptacle using tie wraps or other appropriate securing hardware.
- If mounted horizontally, all wires and cables should have a drip-loop formed in them.

Each SPU is shipped from the factory with a package of four (4) mounting feet and separate instruction sheet that includes dimensions for drilling holes to fasten the feet to the vessel.

Wire Gauge, SPU

Due to the relatively high current requirements of an autopilot compared to many other types of electronic equipment, Using the correct size of wire to connect the various components is very important. Undersized wiring will result in power losses which can affect overall efficiency and performance. Refer to the table below. If in doubt, contact your ComNav Dealer for help.

Once the SPU is securely mounted, you can begin wiring the various components of the system, one at a time.

Function / Use	Type / Gauge
SPU Power Supply	2 X 12 AWG
Steering Drive: 12/24 VDC Solenoid Valve	3 X 18 AWG
Steering Drive: Reversing Motor	2 X 14 AWG <i>(refer to the instructions supplied with the Drive Motor)</i>
Rudder Follower	3 X 18 AWG Shielded cable
GPS, Chart-plotter, Navigation Computer	2 X 24 AWG Shielded cable
Rudder Angle Indicator	2 X 24 AWG

Table 1 – Minimum Recommended Wire Gauges

Connectors & Wiring Label, SPU

Each connector is a pin receptacle, with the pins sized according to how much current will be carried (bigger pins for higher current). Each pin has a signal name, rather than a number, to make it easier to match wires with pins (see connector label, below).

Each pin receptacle mates with a matching plug, which in turn has screw-clamp terminals, into which the wires from the external equipment and devices (battery, drive system, compasses, etc.) are inserted. The plugs allow quick installation and removal of system wiring, yet are fully secure, once the various cables are secured using strain-relieve hardware.

The SPU is shipped with all the plugs required, pre-installed on the matching receptacles with exception of Auxiliary plug that comes with CT7 equipment.

Note that the plug screws must be turned counter-clockwise several turns (using a small slotted screwdriver), to open up the plug's wire clamp, before a wire is inserted into that clamp; the screw must then be turned clockwise until the wire is tightly held in the clamp.

All connectors and pins are labelled, as shown in **Figure 10**.

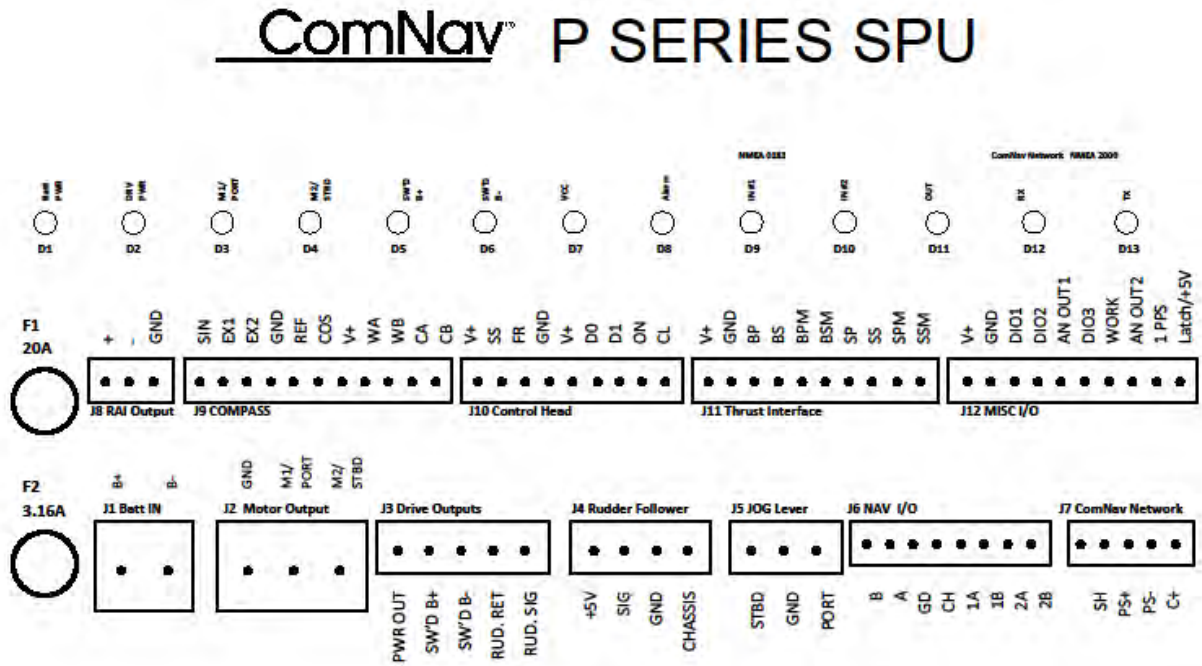

Figures 10a - SPU Plug Wiring Details

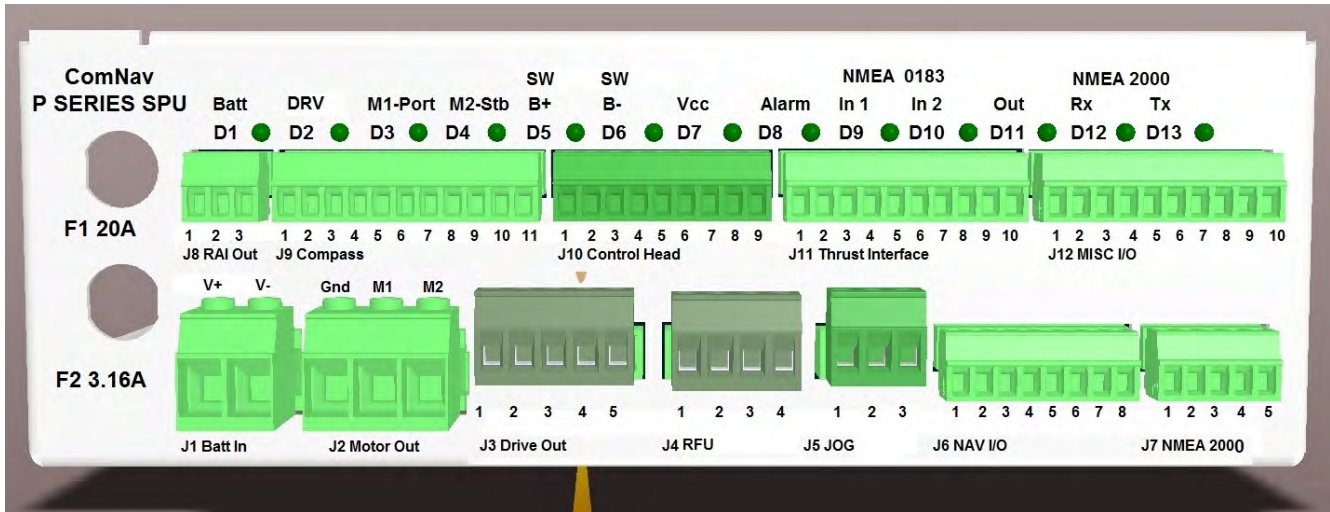

Figure 10b – SPU Connector Details

Wiring the SPU

Power Supply (J1, Batt IN)

The P4 SPU operates on any voltage from 10VDC to 30VDC. This allows operation with vessel battery systems of nominal voltages from 12 to 24 VDC.

Caution! Do not power up the SPU until you have completed the installation, and performed the steps outlined in “Post-Installation Checks.”

Generally, wiring for the positive leg of a DC system will be red or white, while wiring for the negative leg (usually referred to as Ground) will be black.

Power to supply the autopilot should be taken directly from a breaker or distribution panel. The autopilot should be wired into its own individual breaker or fuse. Using appropriately sized wire or cable (see [3.22 Wire Gauge Requirements](#)), wire the battery connections to the connector plug and receptacle labelled **J1 - BATTERY INPUT OF THE SPU**.

Caution! The P4 SPU & the P4 Head are NOT reverse-polarity protected. If you wire the wrong voltage polarity at J1, you will damage the SPU and Control Head! This will void the warranty.

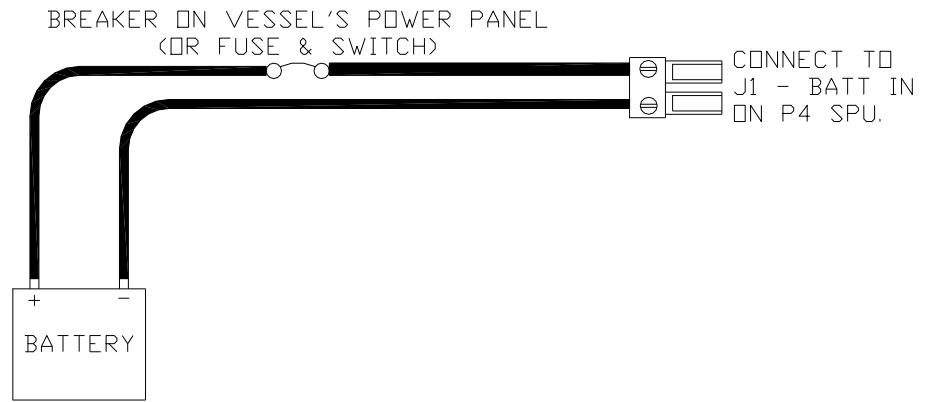

Figure 11 – Typical Battery Connection to SPU

Power Supply Extension

If the SPU is mounted a long distance from the ship's breaker panel, it is recommended that heavy gauge wire be routed between the breaker panel and a terminal block mounted in close proximity to the SPU. #12 AWG wire can then be used between the terminal block and the SPU. This minimizes any voltage drop between the breaker panel and the SPU.

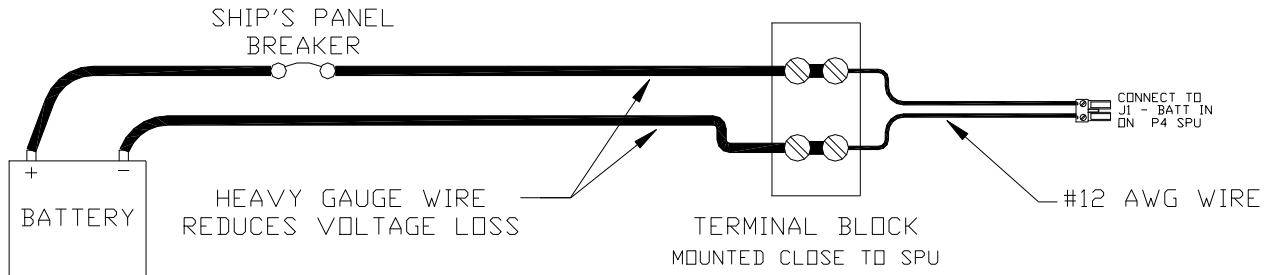

Figure 12 – Reducing Supply Voltage Losses

Input & Output Connections

All NMEA 2000 Network connections from the P4 Control Head, P4 SPU, P4 Remote & NMEA 2000 devices are done through a standard Female or Male end NMEA 2000 drop Cable to the NMEA 2000 network.

Network (J7, NMEA2000)

ComNav Network is an NMEA 2000 port. A 1m Pigtail (flying end) and Male End Cable is provided to connect the SPU to NMEA 2000 network through J7.



Figure 13 - Wiring Connections for P4 SPU to N2000 Network

Rotary Rudder Follower (J4, RFU)

The Rudder Follower is connected to the four-position receptacle on the SPU labelled **J4 – RUDDER FOLLOWER**. Wire the Rudder Follower to the plug-in connector as per the following diagram in **Figure 14**.

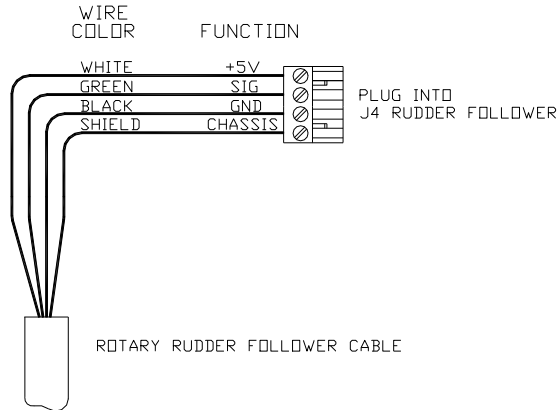
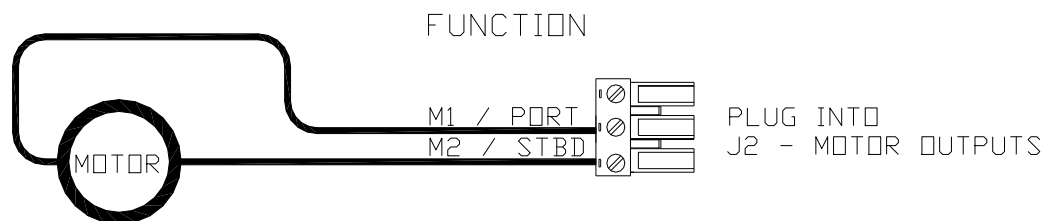

Figure 14 – Wiring Connections for Rudder Followers

Drive Outputs

The P4 SPU is capable of directly driving a variety of steering systems. Optional Drive Boxes are available for those systems not directly by the P4. Contact your ComNav Dealer for more information.

Reversing DC Motor Hydraulic Systems (J2, Motor Out)



Observe Minimum Recommended Wire Gauges. Consult Instructions Supplied With Drive Motor.

Figure 15 – Wiring Connections for Reversing DC Motors

Linear Actuators or Mechanical Rotary Drives (J2, Motor Out & J3, Drive Out)

Some Linear Actuators incorporate a bypass valve. To operate properly, the bypass valve should be activated by the **SW'D B+** output on the SPU. Similarly, most mechanical drives incorporate a solenoid-activated clutch. The clutch solenoid should also be activated by the **SW'D B+** output. Refer to the following diagram in [Figure 16](#):

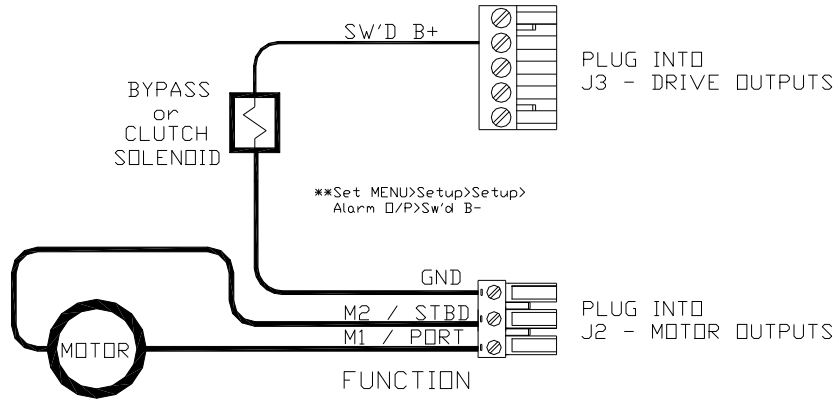

Figure 16 – Wiring Connections for Linear Actuators or Mechanical Rotary Drives

Shunt-Field Reversing Motors (J2, Motor Out & J3, Drive Out)

For shunt-field reversing motors, connect the shunt field coil positive terminal to the **SW'D B+** output, and the coil negative terminal to **SW'D GND** as per the diagram in [Figure 17](#):

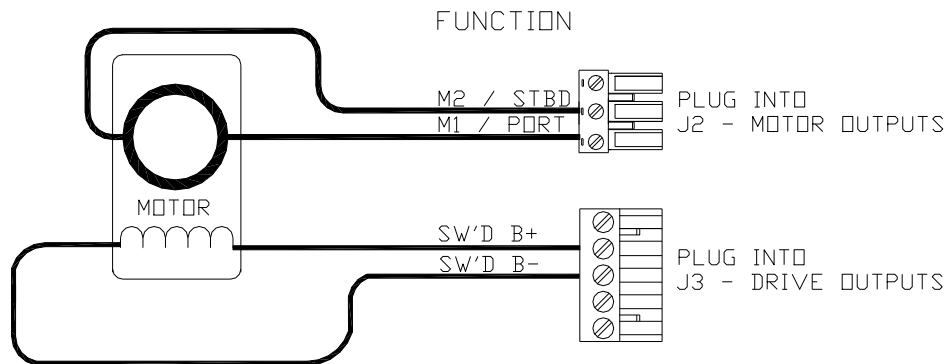

Figure 17 – Wiring Connections for Shunt Field Reversing Motors

Standard Four-Way Solenoid-Activated Hydraulic Valves (J2, Motor Out & J3, Drive Out)

Connection to 12 VDC or 24 VDC solenoids should be made as per the diagram in **Figure 18**.

In this configuration, the autopilot supplies the positive voltage (**SW'D B+**) whenever the autopilot is in **POWER STEER, AUTO, or NAV** modes. **SW'D B+** is turned off in **STANDBY** mode, thus providing an extra measure of safety.

WARNING: Do Not wire an external JOG Lever directly to M1 M2, otherwise you may damage the drive output circuits in the SPU and void the warranty on your P4 system, and/or the warranty of other equipment.

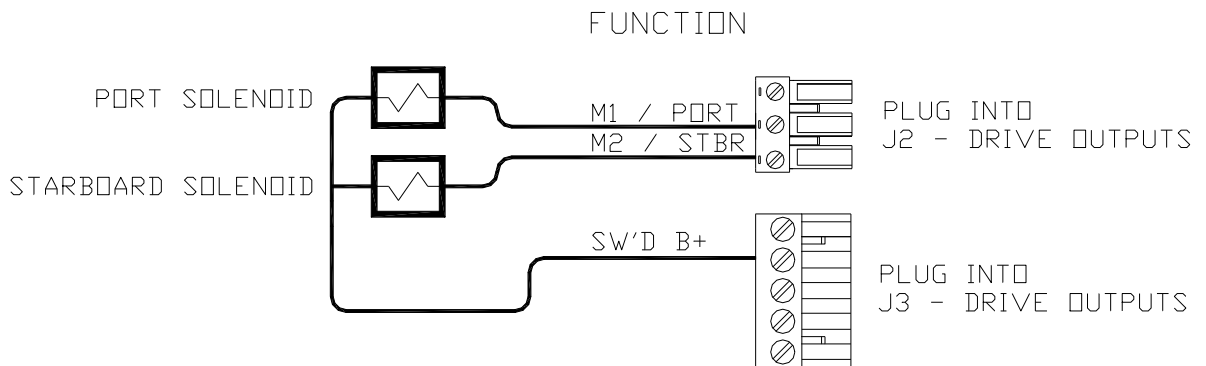

Figure 18 – Wiring Connections for Standard Four-Way Solenoid Valves

NOTE: The diagram in Figure 18 above assumes that an engine driven pump is used for the hydraulic system. In the case of an electrically powered constant running pump, use the following connection, shown in Figure 19:

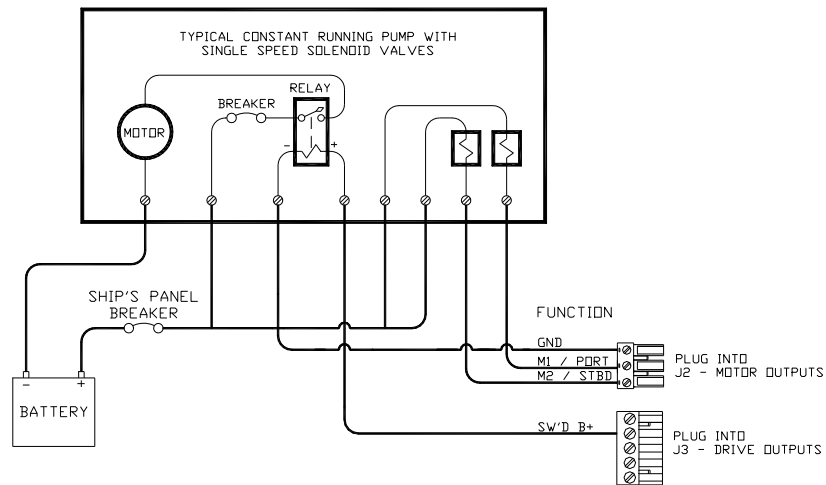

Figure 19 – Wiring Connections for a Constant Running Electric Pump

Alternating Current (AC) Solenoids (J2, Motor Out & J4, RFU)

ComNav’s CT4 Drive Box (PN 20350003) should be used to interface between the P4 SPU and AC solenoid systems. Connect the CT4 to the SPU as per the instructions shipped with the CT4, and the diagram in **Figure 20**:

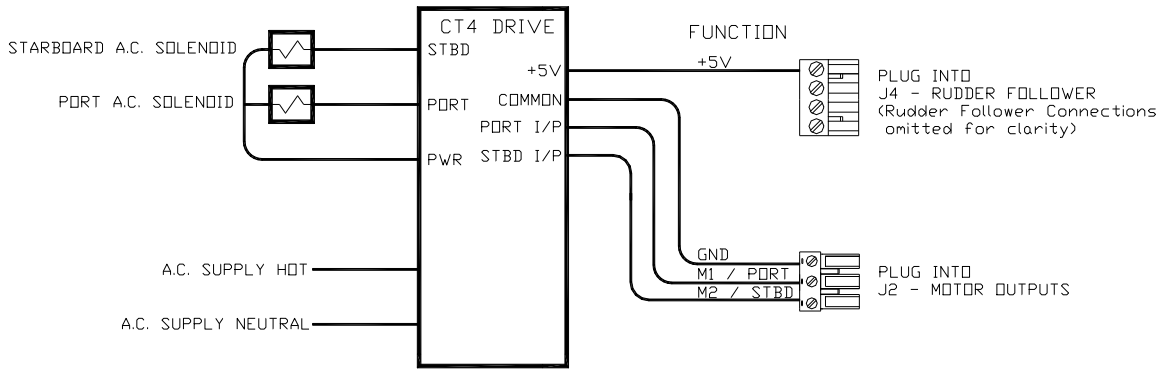

Figure 20 – Wiring Connections for AC solenoids

External Alarm Output (J2, Motor Out & J3, Drive Out)

The Switched B+ or B- may also be used for alarm output if you are not using it for drive purpose.

One of two outputs can be used for the external alarm. Typically, you would choose to connect the external alarm between Battery Positive (**PWR OUT**) and the Switched B- (**SW'D B-**) outputs on **J2**. See the diagrams in **Figure 21** and **Figure 22** for information on how to select these options.

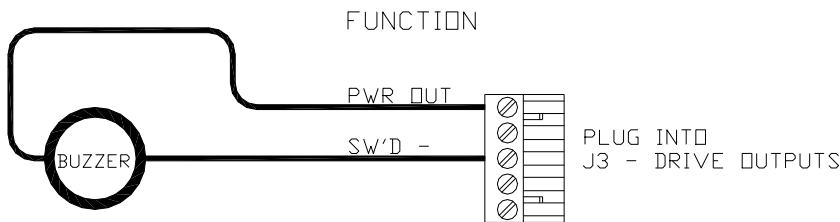

Figure 21 – External Alarm, using SW'D B- Output

Alternatively, you may choose to use the **SW'D B+** and **GND** outputs as shown here:

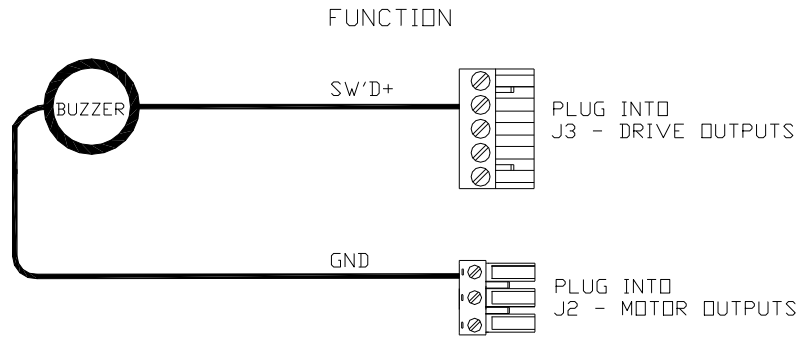

Figure 22 – External Alarm, using SW'D B+ Output

Note: when using the External Alarm configuration shown in **Figures 21 & 22**, there is a small current which will be flowing constantly between the pins, even when the alarm is off. This will not be a problem with many types of alarms; however, with certain types of sensitive Piezo-electric audible alarms, the leak current can cause a constant low-level tone from the Piezo device.

An Application Note is available which describes this potential problem in detail, with suggested remedies. The Note also lists a number of Piezo alarms which are known to work well with P4 systems.

Please ask your ComNav Dealer (or go to ComNav's web site) for Application Note 2007-01.

Power Failures (J1, J2 & J3)

Some installations require separate monitoring for power failures. This can be accomplished with the circuit in **Figure 23**, which utilizes two relays. The coil voltage of the relays should match the supply voltage for the autopilot. The power for the Alarm Supply, which must be a separate, dedicated supply from the autopilot supply, should match the voltage of the alarm.

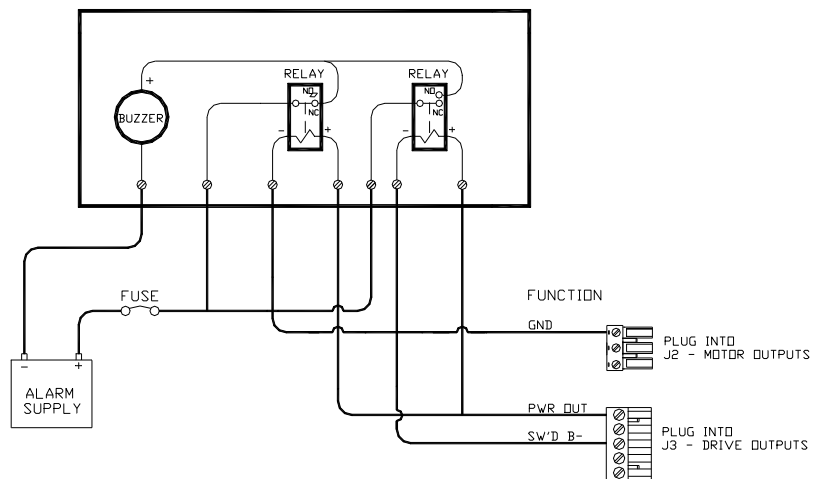

Figure 23 – External Alarm, SW'D B- Output – with Power Fail Option

The alternative circuit, using Switched B+ (**SW'D B+**) as the alarm output:

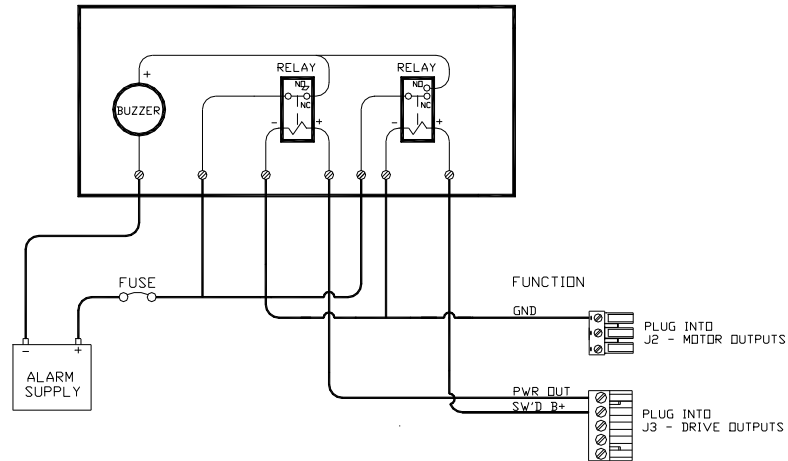

Figure 24 – External Alarm, SW'D B+ Output – with Power Fail Option

Speed Mode and Timing Outputs (J12, MISC I/O)

The P4 SPU outputs two status signals on the **J12 – MISCELLANEOUS** connector. The receptacle is supplied with a 10-pin mating plug.

In addition, a 1 pulse per second (PPS) timing signal is output on **J12**. It is about 5% accurate, and is meant for general-purpose use. For example, some brands of Radar and other navigation equipment require a “1 PPS” timing signal for proper operation.

These two status signals indicate:

- If the system is operating with the Hi or Lo speed steering parameters in effect, in **AUTO** or **NAV** modes
- If the system is operating in **WORK** mode

The status signals are meant to be used to allow indication of those conditions on an external alarm or indicator. While both conditions are indicated on the Control Head’s LCD display, but it is also sometimes useful to have them alert with an external alarm or lamp at locations other than where the Control Head is located.

These two outputs can also be used to control automatic deployment (and retrieval) of external “stabilizer” equipment, to enhance the vessel’s steering and stability when it is moving at a slow speed, or when **WORK** mode is in effect. In both these situations, the boat is moving slowly, and so there is not as much steerageway (i.e., less water flowing over the rudder, so it does not generate as much sideways force).

All three outputs are logic-level, open-drain outputs direct from the SPU's microcontroller, and must be used only within the following voltage/current limits:

- Each output requires its own external pull-up resistor, which **must** be wired **only** to the SPU's logic power supply (5 VDC, created by a linear regulator on the SPU, and available at the V+ pin of **J12**), and to the external alarm, lamp and/or control circuit. The resistor value plus the impedance of the load must total **no less than 3K3 Ohms** (to limit the current into the pin in the "0 V" state to **less than 1.6 mA**).
- If needed, the SPU's ground reference for these signals is on the GND pin of **J6**.

Signal	J12 Pin	When at 0 V	When Open-circuit
WORK MODE	WORK	Normal mode	WORK mode engaged
SPEED MODE	HI SPD	Lo Speed	Hi Speed
1PPS	1PPS	(1 pulse per second, ~50% duty cycle)	

Table 2 – Speed Mode and Timing Outputs

All outputs are ESD-protected – but you still must use them with care:

- Do not use more than about 0.5 m of cable to connect them to the external alarm/indicator or stabilizer-control circuit.
- If you must connect to something farther away than that, use a suitable buffer or isolator circuit – a transistor, a relay or (preferred) an opto-isolator block. With a relay, be sure to wire a fly back-suppressor diode across the coil.
- If shielded wire is used, connect the shield only at the SPU – to the GND pin of **J6**.

Note: *unused pins on J12 are reserved for possible future use.*

Other Connections

Thruster Assist steering option

Thruster Interface

The **J11 – THRUSTER I' FACE** connector is used with the CT7 Thruster Interface in SPU PN 201400002 or as analog thruster assistance SPU-T PN20140006. For using with CT7, the receptacle is not supplied with a mating plug, since the required plug is supplied with the CT7. Refer to CT7 Manual for details. Figure 25 shows the analog thruster assistance outputs in SPU-Tster Interface. The receptacle is not supplied with a mating plug, since the required plug is supplied with the CT7.

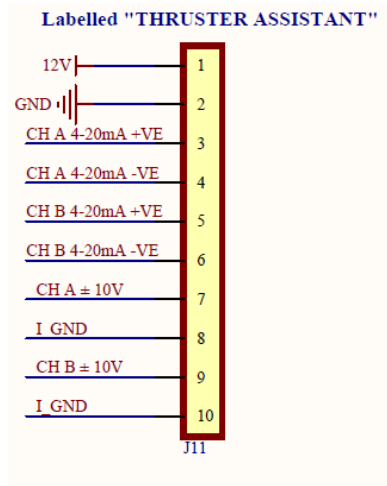

Figure 25 - Thruster Signals for SPU-T

Auxiliary Controllers-CR203/TS203, JOG Levers and Rudder Angle Indicators

Electrical wiring instructions for all these is a combination of the information in the individual equipment's manual, and specific information for the P4 which is given in the following sections of this chapter.

Final Steps and Post-Installation Checks for SPU installation

Before using the SPU for the first time, please verify that the entire system and all its components are safely and securely mounted, and will not shake loose from the vibrations that can be expected in a marine vessel.

Electrical Checks for SPU

Only after all these checks have been completed should you connect the power plug into the J1 BATTERY INPUT receptacle on the SPU.

1. Check the power supply wiring (from the battery/breaker).
2. Verify that the polarity and voltage are correct (use an accurate voltmeter for this).
3. Check for correct wire size, tightness of all connections, fusing, and proper operation of the battery power breaker or switch.
4. Check the connections from the Rudder Follower Unit to the SPU.
5. Check that when the rudder is manually moved from full Starboard to full Port (and vice-versa), that the RFU moves completely freely, and is not being restricted in any way.
6. Check the connections to the drive equipment from the SPU.
7. Check that all cables are neatly routed and secured.
8. Ensure that extraneous materials (bits of insulation, wire pieces or strands, etc.) have been removed.
9. If you have a magnetic sensor or a fluxgate compass, check the connections on J9
10. If you have a NMEA 0183 compass (such as SSRC), check it is connected to NAV1 or NAV2 port
11. If you have an old ComNav CR203 or TS203, check it is connected to J10.

Caution! During the first few weeks of operation, repeat the checks above at least once.

Control Head

Mounting Control Head

The P4 Control Head is typically mounted in the vessel's wheelhouse. It can also be mounted in more exposed locations, such as on a flying bridge, since it is fully splash-proof (however be advised that the P4 Control Head is not submersible).

When ordered as part of a P-Series System, each Control Head is supplied with a flush mounting kit, including a bracket for flush mounting. The flush-mount is meant to be used when the Control Head is installed inside the boat. If using the optional Deck Mount or commonly known "Trunnion Mount" bracket kit; the unit is generally mounted on the console or in an overhead bulkhead location.

Complete instructions, including drilling and cutting templates for each type of mounting, are included with each kit.

Figure below shows the back of the Control Head for installation

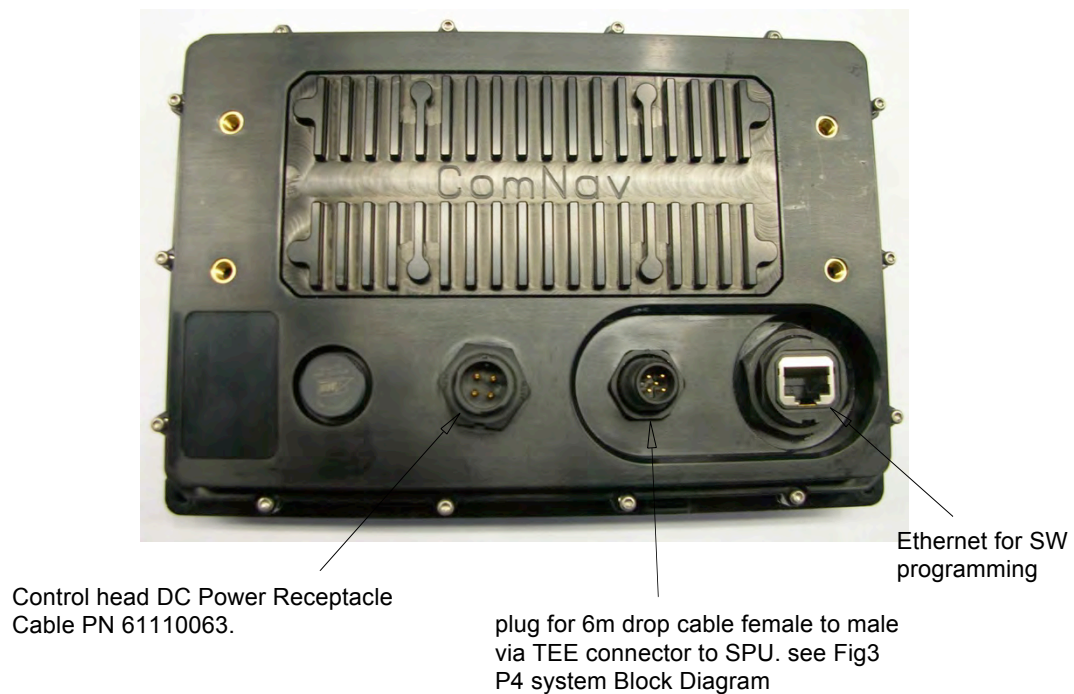

Figure 26 - P4 Control Head - Rear View

Wiring the Control Head

The P4 Control Head operates in the same voltage range as the P4 SPU. See 3.2.2 Wire Gauge Requirements (see Table 1) for details.

Caution! The P4 Head are NOT reverse-polarity protected. If you wire the wrong voltage polarity at J1, you will damage the SPU and Control Head! This will void the warranty.

Power to supply the P4 Control Head should be taken directly from a breaker or distribution panel. The autopilot should be wired into its own individual breaker or fuse. See figure 27 below.

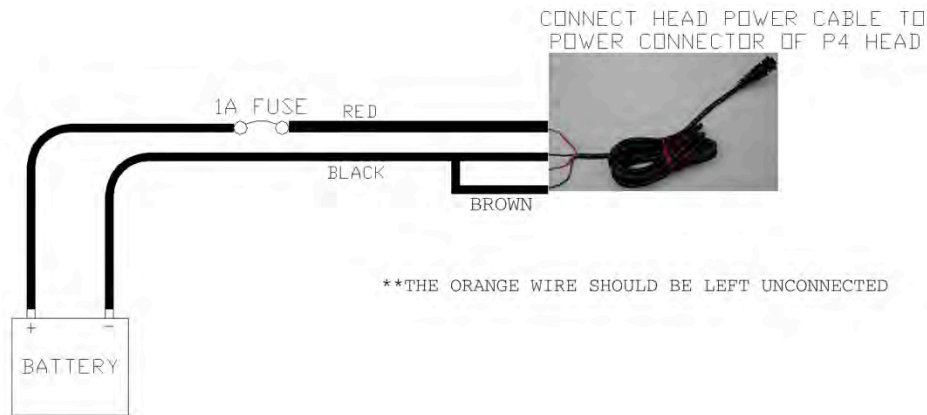

Figure.27 – Battery Connection to Master P4 Head

The power cable of the P4 control head is also used for configure the Master station in the P4 autopilot system.

All control heads and remote controllers communicate to the SPU through the NMEA 2000 bus. When a station turns on, it starts from the “repeater” status, meaning it monitors all data from the SPU but cannot operate the SPU. The user has to switch the Head to the “command” status before it can be used to control the SPU.

A **Master** station is the one that will automatically place itself to the “command” status after the device is turned on. To wire a P4 Head to a Master station, connect the brown conductor of the P4 head power cable to the negative battery terminal. If you have more than one P4 Heads, only one of them should be wired as a Master station.

NMEA 2000 network connection

Connect a standard NMEA 2000 drop cable between the network and the P4 Control Head NMEA 2000 port.

Ethernet

The Ethernet port is used for the purpose of software upgrade. Refer to P4 software upgrade brief for details.

Other equipment

ComNav NF4 and TS4 Remote Controllers are NMEA 2000 devices. Installation for these devices should follow the guidance from NMEA 2000 standard.

At default, P4 autopilot uses a heading device and navigation device from the NMEA 2000 network. Refer to the manual of these devices for installation details.

Final System Installation Verification

Before you power up the P4 autopilot for the first time, verify your installation is complete.

1. All power supply ports have been properly wired
 - a. SPU power port at J1
 - b. P4 Control Head at the 4-pin power connector
 - c. The NMEA 2000 network has proper power supply
2. The SPU installation is complete and the final check in section xxx has done
3. One Control Head is wired as the **Master** station
4. A Heading sensor exists in the NMEA 2000 network, or a compass has been wired to the SPU
5. To use the NAV mode, a plotter or other navigation device must be connected in the network; or a navigation device is connected to NMEA 0183 on SPU
6. The NMEA 2000 network or the CAN bus is properly terminated at the both ends of the back bone

Getting Started

This chapter describes all the basic concepts you need to be familiar with when using your P4 Advanced Autopilot System, and the steps needed to prepare it for use.

Autopilot Operations

After it is installed, almost all of your interaction with your autopilot system will be done by means of the Control Head. These include:

- selecting an operating mode
- setting up the parameters you wish to use in each mode
- monitoring your vessel's Heading
- setting a desired Heading to be followed
- making Special Turns
- monitoring the various system status items

System On/Off

The P4 SPU, once wired to a battery, will always be in power on status. It can only be powered down by removing the power supply (turning off the circuit breaker or safety switch if installed (recommended when fused)).

This is also true for P4 control Head and P4 series of remote controllers. The STANDBY/ON/OFF button on the P4 Control Head is used to turn the system to a sleep mode where the display is turned off and minimum current is consumed.



Table 3 - Turning off P4 system

To turn off the P4 (at any time), press and hold the STANDBY/ON/OFF button. The autopilot will switch first to **STANDBY** mode, if it was not already in that particular mode.

At that point, if you keep pressing the button, the autopilot will start a 3-second power-down sequence. Once the countdown has expired, the display will go blank. All outputs from SPU will stop. Other P4 stations and remote controllers in the network that are linked to the same SPU will also blank out. The whole system is in Sleep mode.

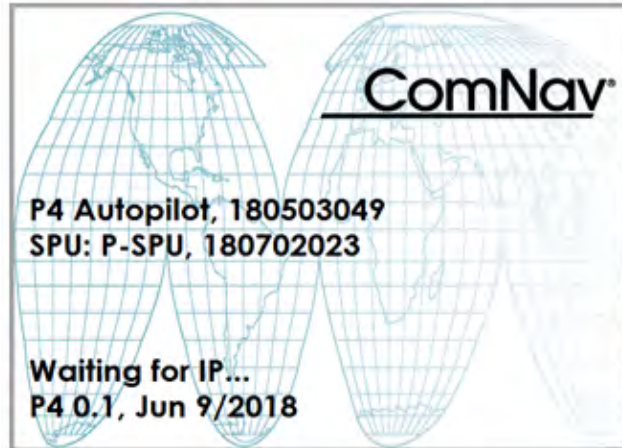

Figure 28 – Introductory display

If you release the STANDBY/ON/OFF button before the 3-second countdown has completed, the autopilot will abort the countdown, and remain in **STANDBY** mode.

Turning on P4 system from Sleep mode

Press and hold the STANDBY/ON/OFF button on a P4 will wake up the P4 system. All installed controllers for the same SPU restart as if they are powered on.

Using the Control Head – LCD Screen and Buttons



Figure 29 – Using the Control Head

The elements of the Control Head (with reference to the identifiers above) are:

LCD Screen. As long as the P4 system is powered on, the LCD screen normally displays the compass heading, rudder angle, and mode of operation; it can also be displaying desired heading, system status, other information, and various menus. The overall set of items being displayed changes in response to the various command buttons listed below (the screen shown above is the initial screen, which appears for a few seconds after Power On).

BUTTON DESCRIPTIONS

ALL MODE BUTTONS: STBY, WORK, NAV, AUTO & P-STR

To change from one mode to another, a short press of almost one second is required to prevent accidental mode changes. Double pressing a given mode button accesses a shortcut menu pertinent to that mode, double press to exit menu. Double press timing, *think; one, two*.

- 1) **ROTARY KNOB- ALARM:** Press Knob to silence an alarm. Knob press is an operative ENTER.
When in MENUS, rotate to move between selections, press knob to gain submenus, press to select an item for change. Rotate to change values or choices, press to go back to item list, choice will be saved. Double press button to exit menus.
When in AUTO mode, each click, left or right=1 degree of course change, left or right. A quick spin of the knob, left or right=10 degrees of course change left or right respectively. Pins are additive. 3 spins =30 degrees of course change.
- 2) **STANDBY/ON/OFF** button. To Turn On, Press until the screen lights up. Short Press STBY to enter Standby from a steering mode. **S** appears on screen. Press and hold for OFF, screen will prompt with count-down to OFF. Double press for shortcut to USER CONFIGURATION in main SETUP menu.
- 3) **BRIGHTNESS** button. Long press toggles from Day to Night palette. Short press brings up brightness level scale on screen. Repeated short presses adjust brightness level in a loop.
- 4) **WORK** button. Special mode to adapt rudder offset angle and movement when engaged in slow speed work situations. Work is accessed when the pilot is in AUTO or NAV only, See WORK mode section for more details. Double press to access or cancel shortcut to WORK menu in main SETUP menu.
- 5) **NAV** button. Turns the Autopilot over to properly configured NMEA steering instructions from the ship's navigation system to an active waypoint, go to mark or route. **N** will appear on screen. When in NAV, press again to toggle between 2 NAV screens. Double press to access or cancel shortcut to NAV menu in main SETUP menu.
- 6) **AUTO** button. Pressing AUTO command the autopilot to assume the compass heading being read at the moment as the commanded course to steer. **A** will appear on screen. Change course with KNOB. Double press to access or cancel AUTO menu from main SETUP menu.
- 7) **COMMAND (CMD)** button. Press to take command from any other station. **R** will appear on the screen if another station is in command. Double press gains access to complete menu trees for: SYSTEMMENU, NETWORK CONFIG., SETUP &FACTORY. SETUP is comprised of all shortcut menus gained by double pressing the individual mode buttons. Double press to go back or exit.

- 8) **PORT ARROW** button. Pressing and maintaining this button while in POWER STEER mode moves the rudder to port for as long as the button is held. The Rudder will remain at this position until brought back by opposite Arrow button. Pressing and maintaining this button while in AUTO, NAV or WORK modes allows you to avoid obstacles in the vessel's path, by turning to port. Releasing the button automatically recovers your original Heading or Track.
- 9) **TURN** button. Short press TURN button to select one of the 5 pre-programmed turns, MOB, CIRCLE, U-TURN, FISH -ZAG or PRE-TACK. 1st up is selected in the User Config menu (double press the Standby button). Repeated presses on the TURN button will step through the other choices or selection items. The selected turn is shown on the display. To initiate the selected turn, press the ARROW key corresponding to the desired turn direction. See the Error! Reference source not found. section for more details on setting the default turn from the Special Turns available.
- 10) **STARBOARD ARROW** button. Pressing and holding this button while in POWER STEER mode moves the rudder to starboard for as long as the button is held. Pressing and maintaining this button while in AUTO, NAV or WORK mode allows you to avoid obstacles in the vessel's path, by turning to starboard. Releasing the button automatically recovers your original Heading, Track or Angle.

Using the operating mode menus is fully described in the related sections, later in this manual.

System Setup

A minimum P4 Autopilot system requires these components: An P4 SPU, a P4 controller (Head), and two main-inputs: A Heading Source plus a Rudder Follower Unit or Interface.

By default, the SPU looks for heading data from the NMEA 2000 network. The Heading may come from other connection ports on the SPU. Refer to other equipment in Appendix for how to use a ComNav Magnetic Compass, a Fluxgate compass, Rate Compass or other NMEA 0183 compliant compasses.

When you have wired and verified your installation as described, the first time the system is powered on, the P4 SPU and P4 Head will link themselves up automatically. You should be able to see on P4 Head the system enters Standby mode.

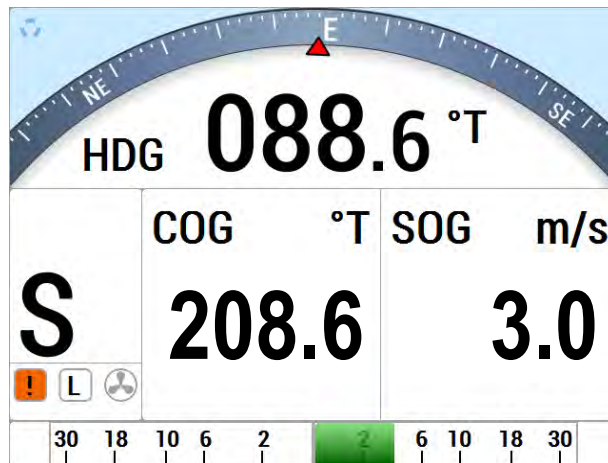

Figure 31 - Autopilot in Standby Mode

First time power on

The first time you power on your system, P4 SPU will also search for suitable data sources it needs in various operations from the NMEA 2000 network. The following table shows what data are used for SPU

Data Source	Required in Operation modes	Where to select/change a source
Heading	All modes	Network Config
Rudder	P. Steer, AUTO, NAV	Fixed from RFU port
Navigation	NAV	
Position	AUTO ALC mode	
Control unit	All modes	Network config=>Linked SPU

Figure 32 - Data sources used by P4 Autopilot

If you have more than one NMEA 2000 device that can provide the same type of data the SPU looks for, the SPU will pick up the device it first receives the required PGN. Once SPU has found and saved a device, it will use the same device in the next power cycle. You can only change this source through the Network Configuration menu (refer to Network Config Menu for more details), or through a network reset to allow the SPU to pick a new one.

To simplify the initial match up, it is recommended after you wire the system, you only power on one device for each data type. This way, the SPU will connect the same one.

If you want to use a non-NMEA 2000 data source, for example a fluxgate compass for heading, you can change the input port for a particular source. Refer to Table 2 - SPU Available Input Ports

Dockside Setup

Before the P4 Autopilot can steer your vessel, at the minimum, you need to go through the Drive Setup to fit the SPU drive circuit with your steering system. This is done through the Dockside Setup

Entering Dockside Setup

When your P4 system is in Standby mode, press and hold the Power button until the system is in Sleep mode.

Release the button and wait for 3 seconds. Press the Power button to turn on the autopilot again. During initialization, when you see “Press < + > to Enter Dockside”, press the 2 arrow buttons simultaneously until you see the message “Enter Dockside Setup ...”.

Note you can only enter Dockside Setup when the SPU is in Sleep mode before you press the Power button on the P4 Controller. Therefore a sure way to get into Dockside Setup is always starting from turning off the system.

The following section describes each item in the Dockside Setup menu and how to use the menu to setup the devices directly connected to your SPU.

Note: in the follow descriptions,

Move to means turning the knob to move the highlight line up/down

Select means pressing the Enter button when an item is highlighted

SPU Reset

A full reset of all the P4 SPU's operating parameters will be initiated when the ENTER button is pressed and held until the word “Reset” changes to upper case “RESET.” This change indicates that a full reset has been completed.

Resetting means that any configurations you have set (including Compass and Drive Setup), as well as all parameter adjustments you have made, will be lost. You should use the full-reset option only on the advice of an authorized ComNav service representative.

Caution! A “full reset” means that ALL of the parameters in the spu will revert back to the default settings installed at the factory. All custom information or parameters set through sea trials will be lost.

Vessel Type

Set the vessel type to match (as closely as possible), the kind of craft that the autopilot is being installed on. The system then automatically selects a specific set of equations and constants – for use in the P4’s steering algorithms – which have been found to work reasonably well with typical craft of the chosen type. Also selected are the initial values of the Steering Parameters used in those equations (see the **Sea Trials** and **Auto Menu** sections for more details).

NOTE: during Sea Trials, and later in normal operation, you can adjust any or all of the Steering Parameters’ values, to better suit your own vessel, and/or the current sea conditions.

Setting	Vessel Type	Comments
Stern	Stern Drive	Choose this for planning-hull boats with outboards or stern-drive legs.
Displ	Full Displacement	Choose this setting for full displacement boats that do not plane or rise out of the water at cruising speed.
Semi	Semi-Displacement	Choose this if your boat rises partially out of the water at cruising speed.
Large	Large, with a slow Helm response	Vessels in this category are typically over 125’ LOA and/or 100 GRT (e.g., freighters, tankers, dredgers, car/truck/passenger ferries, fishing vessels, processors, etc.).

Table 4 – Vessel types

Compass Setup

Pressing the **ENTER** button when this line is highlighted starts the configuration menu for various compasses the autopilot can work with.

You should make sure that you have connected your compass to the correct port. Wiring diagrams are provided in the System Overview for Compasses. You should also refer to your compass manual for special requirements and Appendix section of this manual. See the **Compass Setup – Dockside** procedure for full details.

Drive Setup

Pressing the **ENTER** button when this line is highlighted starts a script in which the autopilot automatically determines the orientation of the Rudder Follower Unit, measuring the physical limits of the rudder's range of motion, figures out what kind of steering system (i.e. reversing motor, solenoid, etc.) is installed, and then tests all of these to make sure everything is operating properly. See the **Drive Setup** section for more information.

Exit

Press the **ENTER** button to exit the Dockside Setup menu and restart the autopilot in STANDBY mode. Alternatively, you can press and hold the red STANDBY button to shut off the autopilot.

Alarm O/P (Alarm Output Port)

This parameter controls the function of the External Alarm Output. See the **Watch Alarm** and **External Alarm** sections in the **Advanced Operations** chapter for full details.

Thrust Type

P4 SPU supports 4 options for the thruster used in used for the thruster assist function in the AUTO mode.

To use On/Off or Proportional thruster with a CT7 box, select On/Off or Prop.

If you are Sleipner thrusters installed on your boat, and you have a Sleipner S-gateway in the network, you can select S-link. P4 SPU will use your Sleipner thrusters as an assistant on slow speed.

If your Sleipner thrusters are controlled by PGN 65280, the instances P4 SPU supports is Bow (Port) Thruster and Stern (Port) Thruster. Refer to your Sleipner thruster manual for details.

If your P4 SPU is SPU-T model, the SPU has 2 channels of built-in +/-10V and 2 channels of 4-20mA thruster outputs. Select SPU-T as your thruster type.

Thrust Min

Thrust Max

These 2 settings limit the percentage of thruster used in the thruster assist function. If you have set a thruster type in Thruster Type other than None or On/Off, you can adjust how much thruster you want to apply. Your thruster manual should have explanations on what values to select.

Dockside Setup

The following section describes how to set-up any or all of the devices (such as Magnetic/Fluxgate compass, Solenoid, Rotary Feedback, and/or NMEA0183 devices) wired directly into the P4 autopilot system.

- First, input your vessel type into the autopilot, and then specify the characteristics of the Rudder Drive mechanism on the craft.
- Next, input what type of Compass(es) it will be using, and have the system verify that it can use those compass(es).
- Next compensate and calibrate all of your compasses.
- Next, do the initial settings of the various operating parameters (Rudder Gain, etc.) at high and low speed.
- Finally, test how well the autopilot performs in various sea conditions, re-adjusting parameters as needed.

NOTE: The configuration will be transparent to the N2K network.

Selecting Vessel Type

1. Power the system up, in the Dockside Setup menu
2. Select the Vessel Type menu line shown in [Figure 33](#), and set the type of your boat (see [Table 4 - Vessel Type](#)).

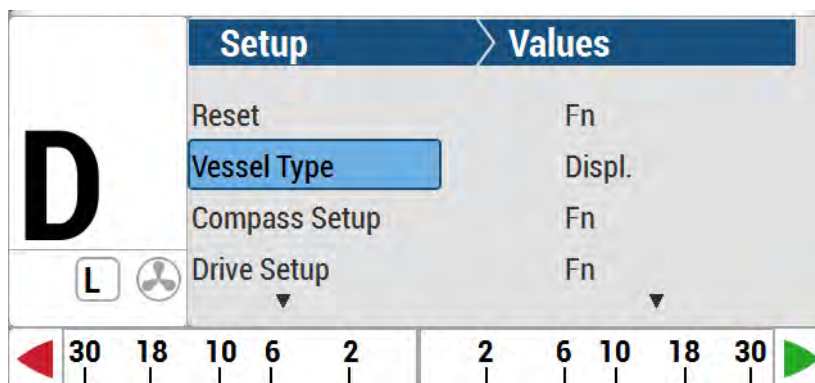

Figure 33 – Set Vessel type

NOTE: At this step in the setup process, all of the various Vessel Types (Displacement, Stern, Semi, etc.) can be selected, for P4 autopilot.

Drive Setup

The procedure for setting up the autopilot to work properly with your boat's steering system varies, depending on whether or not you have fitted a Rudder Follower Unit.

For a P4 system which has an RFU fitted, the Rudder's characteristics are automatically measured by the autopilot, during **Drive Setup P4**.

However, in both cases, the purpose of the procedure is to find out:

- The type of drive system (solenoid(s) or a reversing motor) the boat has.
- The orientation of the RFU (if one is fitted).
- The direction the rudder moves in relation to the voltage polarity of the drive outputs from the SPU.
- The Hard-Over to Hard-Over time of the rudder
- The physical limits of the rudder's travel.

To begin the Drive Setup procedure, scroll through the Dockside Setup menu to "Drive Setup", then press the **ENTER** button. This will start the setup's automated script.

You will see a series of screens, prompting you for various actions or information. For example: move the rudder all the way to Port, or center it, or enter the maximum deflection of the rudder, etc. (This could be an actual rudder, an I/O leg, an outboard motor, etc. – all are referred to here as "rudders").

Some points to keep in mind while doing this procedure are:

- Use the boat's manual steering system (wheel, tiller, etc.) to move the rudder, when prompted.
- When moving the rudder to the maximum Port or Starboard position, be sure to move it all the way to the physical stops.

NOTE: in normal operation, the autopilot always stops the rudder a few degrees away from the position of the physical stops, to avoid unnecessary, repeated impact against them.

The speed at which you move the rudder manually is not critical, nor does it matter if you move the rudder back and forth a bit when it reaches the requested position.

Do not be concerned if the Rudder Angle Indicator shown on the screen initially goes in the wrong direction. The autopilot will correct any inconsistencies during the procedure.

If for some reason, the autopilot was not able to detect the type of drive, you will see a "Drive Detection Failed" screen. If this happens, go back to the Dockside Setup screen, re-check all the drive wiring, and then re-start the Drive Setup procedure (The word "Drive", as used on the menus, sometimes refers to the hydraulic and/or electrical system that the boat uses to control the steering mechanism (rudder, etc.), and other times to the mechanism itself).

If you continue to have problems, contact your ComNav Dealer for assistance.

Drive Setup Continued

After detecting the drive type, a P4 with an RFU gives you the option to bleed your hydraulic steering system. If you wish to do this, please refer to the hydraulic system's manual. When all bleeding is done, press the **ENTER** button on the Control Head.

If you do not have a hydraulic system, just press the **ENTER** button on the Control Head.

When the P4 with an RFU is testing the drive system's performance, it will run the rudder from hard-over port to hard-over starboard a number of times. It will also make a series of short movements of the rudder – quick starts and stops – in order to determine a base reference for how the steering system responds to the typical small movements the autopilot uses during normal operation.

After the autopilot has determined the time span for a Hard Over to Hard Over movement of the rudder, there are several possible results:

- If the HO-HO time is fast, the autopilot will have difficulty steering the vessel properly and you need to revisit the hydraulic setup.
- If the HO-HO time is too slow (more than ~22 seconds), you will see a message on the screen.

In either case, you will need to make some changes to the drive system, to slow it down or speed it up, as determined by your specific application.

On most boats, it is probably not necessary to slow down the rudder, unless the HO-HO time is less than ~8 seconds. However, every vessel is different, and so the choice is left up to you.

Adjust your Hydraulic pump for either more or less flow depending on the HO-HO time change needed.

. When Drive Setup is all done, record the settings and choices you made, in **Settings - Compass Setup – Dockside**

Compass Set-up

Highlight Compass Setup shown in [Figure 34](#) and press **ENTER**. The list of all four supported compass heading sources will be displayed (see [Table 5](#)).

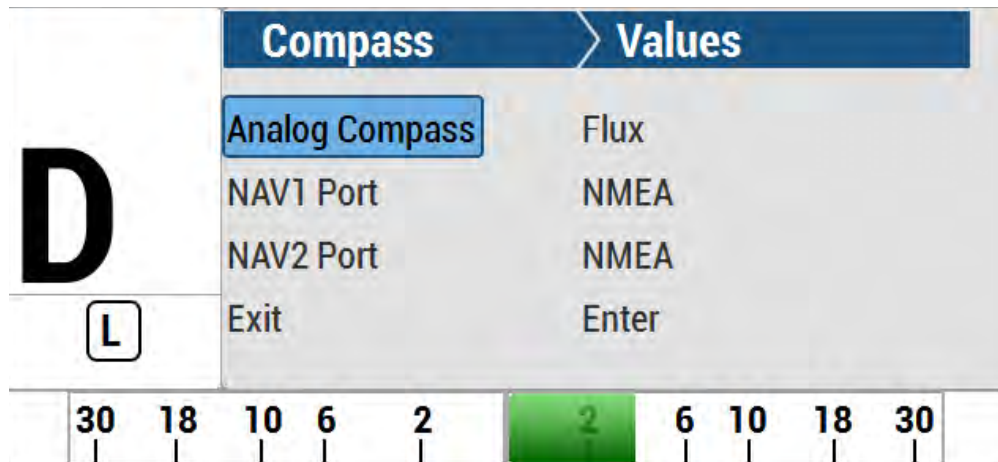

Figure 34 – Set Compass Type in Compass Configuration menu

Analog Compass

If you have an analog compass connected to J9, you can configure it from this compass menu.

First select the type of your analog compass – fluxgate or magnetic.

When you have selected your compass type, the autopilot will test the signals from the port, and you will be prompted if the test has passed or not.

If you have a fluxgate compass, the autopilot will promote you whether you want to calibrate it. Do not calibrate it if you are tied to the dock. You should calibrate your compass while you do sea trials.

*NOTE: during these steps, the autopilot may display an INVALID HEADING alarm message. These alarms can be ignored, by hitting the **ENTER** button.*

Once a compass is “found” during this procedure, the alarms should clear.

NAV1 and NAV2 Ports

You can use any heading devices that outputs NMEA 0183 HDG, HDT, or HDM sentence(s). Some of these devices have a special calibration procedure. Often no user interaction is needed for the calibration. For this type of compasses, there is no configuration required. Refer to your compass manual for details.

P4 supports the calibration of ComNav SSRC rate compass. If you want to manually calibrate your ComNav SSRC rate compass, you can

- a. Connect the gyro compass to NAV1 port
- b. Change the selection for NAV1 from NMEA to SSRC.

Note: you should do compass calibration at the start of the sea trials. For ComNav Fluxgate compass follow Dockside Menu instruction for compass Calibration process. For Rate Compass (SSRC), follow Rate compass manual instructions enclosed with the unit. For ComNav fluxgate compass(analog) follow procedure laid in Dockside setup process.

Sea Trials

Sea Trials allow you to test out the basic functions of your P4 autopilot while underway, and to fine-tune the steering parameters for the best performance. The goal is to achieve accurate course-keeping, and smooth, rapid changes of heading, without excessive movements of the boat's rudder.

NOTE: before you begin Sea Trials, it's a good idea to review how you steer your vessel manually, and how that compares to how the P4 performs when steering the boat under autopilot conditions. Please re-read the chapter on "How Autopilots Work."

During Sea Trials, you will test the default Steering Parameters of the P4 on your specific vessel, and make adjustments if necessary. When the Steering Parameters are properly adjusted and fine-tuned for your boat, the autopilot will do the same as you would manually; which is to allow the boat to adapt to the body of water, yet still maintain as straight a track as possible in the current conditions, on the desired heading or course.

NOTE: To accurately and successfully complete Sea Trials, you must be familiar with the operation of the autopilot in AUTO mode and with the specifics of the Auto menu.

Sea Trial Procedure

The initial Sea Trials should be done in relatively calm conditions.

Adjust Rudder Gain and Counter Rudder for Hi Speed

1. Bring the boat up to a speed where the boat's rudder (or steerable-thrust system, such as an outboard or I/O leg), provides sufficient steerageway that it has accurate, firm control of the boat's direction of travel. Typically, this will be less than your normal "cruising speed," perhaps by quite a margin. For many boats, this will be around 7 Knots.
2. Bring up the Auto menu, highlight "Parameter Set" and select "Hi".
3. If ALC is set to "On", highlight it and set it to "Off".

4. Start with “Rudder Gain” and “Counter Rudder” set to the factory defaults (for Hi): 5 and 3.
5. Highlight “Seastate” and set it to 1.
6. Highlight “Turn Rate.” Select a setting that is approximately $\frac{3}{4}$ of your boat’s comfortable turning rate at a normal cruising speed (to find your “Comfortable turning rate,” simply time a complete 360° circle while the vessel is performing a safe yet tight turn, at the normal cruising speed. A “Comfortable turning rate” is 360° divided by the number of seconds it took to complete the circle).
7. Exit the Auto menu.
8. Switch to AUTO mode (before switching into POWER STEER, AUTO or NAV modes, the rudder must be at the dead-ahead position). The autopilot will then automatically take your current heading and use that as the Course to Steer.
9. Run for about 5 minutes. If the boat “esses” back and forth more than about 3 degrees, bring up the Auto menu and reduce the Rudder Gain setting by 1 step, then test again.

Make a medium Heading change, say 15°– 20°, with the COURSE CHANGE knob.

Observe how the boat responds, as it turns and settles into the new heading:

- If the boat stops turning before the new heading is reached and then approaches it slowly, either increase the Rudder Gain by 1, or decrease the Counter Rudder by 1.
- If the boat overshoots the new heading, and then makes several turns back and forth across the new heading before settling down (known as “essing” or “overshooting”), either decrease Rudder Gain, or increase Counter Rudder by 1.
- If the boat approaches the new heading, shies away, then approaches and shies away again, decrease Counter Rudder by 1.

Continue making those medium heading changes, adjusting Rudder Gain and Counter Rudder as needed, until the boat settles smoothly onto the new heading without excessive overshoot.

You can leave the higher speed tests for later, if it is not safe to run at that speed where you are doing your Sea Trials.

Adjust Turn Rate for Hi Speed

1. Adjust the Turn Rate setting to the full comfortable rate (per the previous step 6).
2. In AUTO mode, make a few course changes of 20° or more, to ensure that the rate of turn is indeed comfortable at normal cruising speed; if it is not, reduce the Turn Rate setting until it is.

Adjust Seastate for Hi Speed

1. To set Seastate, switch to AUTO mode, and then watch the Port and Starboard rudder movement arrows at the ends of the screen's RAI bar. In normal conditions, there should be rudder movement about 15% to 20% of the time.
2. If the autopilot is over-active, increase the Seastate until the arrows blink less often. If the autopilot is under-active, decrease the Seastate.

Adjust Rudder Gain, Counter Rudder, Turn Rate and Seastate for Lo Speed

1. Adjust boat speed to what will be your lowest normal "low speed" – that is, the lowest speed at which you will ever choose to use the autopilot (for most vessels, a good speed to do the "low speed" adjustments is at or below the maximum speed in a Speed Control Zone or "no wash" area – usually 5 Knots).
2. Bring up the Auto menu, highlight "Parameter Set" and select "Lo".
3. Repeat the steps in the Hi speed Rudder Gain and Counter Rudder adjustment process discussed previously (the starting value to use for Lo speed Rudder Gain is the factory-default of 8).
4. Adjust the Lo speed Turn Rate setting to suit your preference. Make a few Course changes of 40° or more to ensure that the rate of turn is comfortable.
5. Adjust the Lo speed Seastate setting to suit your preference.

Adjust Speed Trip Point

1. Bring up the Auto menu, and set the Trip Point speed to something mid-way between the speeds used for setting the Hi and Lo speed parameters in the steps discussed previously. This should be a speed you will never travel at for any length of time – for example, in a planning-hull boat, it would be a speed just a little bit less than where the hull starts to get up on the step.
2. Bring up the Auto menu, highlight "Parameter Set" and select "Auto".
3. In AUTO mode, change the boat speed back and forth between the Lo and Hi speeds you will normally use. The vessel should continue to maintain a straight Track along the heading you are on, and you should see that the display's Parameter Set indicator changes back and forth between "L Auto" and "H Auto" as you change speeds.

Adjusting for Rougher Sea Conditions

The primary desire of any autopilot user is that the system steers the boat safely and accurately, across all sea conditions.

Adjusting the steering parameters in calm conditions – as you did during the initial part of the Sea Trials, above – gives a base reference for all other conditions. After doing those adjustments, you can then venture into rougher sea conditions.

Take all the time necessary to ensure that you are getting the best performance from your autopilot!

Some suggestions and points to keep in mind:

- Typically, you will find that you will only need to make small changes to the “calm condition” steering parameters already set, to handle a wide variety of sea conditions.
- Observe the wake of the boat while maintaining a straight Course in AUTO mode. This is one of the best indications of how well the autopilot is steering.
- The vessel should come on to each new Course Heading smoothly. Any undershoot or overshoot can usually be observed in the wake. Adjustments to Rudder Gain and Counter Rudder, as in the tests mentioned previously, are how you achieve “smooth.”
- Generally speaking, the Rudder Gain and Counter Rudder settings for Hi speed will be less than those for Lo speed.
- As the seas get rougher, you will probably need to increase the Rudder Gain 1 or 2 steps.
- In very rough conditions, you may want to reduce the Counter Rudder setting, as well as increasing the Rudder Gain.
- In quartering seas, you may wish to increase Rudder Gain and the Seastate settings. This will allow the boat to yaw a bit more as it comes off of the waves, but typically the boat will come back onto course with minimal rudder movement.
- In the tests above, you will have determined the Turn Rate value which corresponds to the full “comfortable turn rate” of your boat.
- You do not need to leave the Turn Rate always set to that value, however. You can, and should, change the Turn Rate as required, to have safe, comfortable turning rates for the current sea conditions. You may also want to lower the Turn Rate for other reasons.

Once the autopilot system is steering satisfactorily, make a note of all your steering parameter settings, and manually record them in the Settings chapter, at the back of this manual.

Basic Operations

Main Menu

P4 System allows user to adjust the screen to suit backlight, time, language and many other useful parameters. See below in Figure 35 for a full list of menu items.

System Layout

Each menu item can be adjusted allowing comfortable screen displays and data readings.

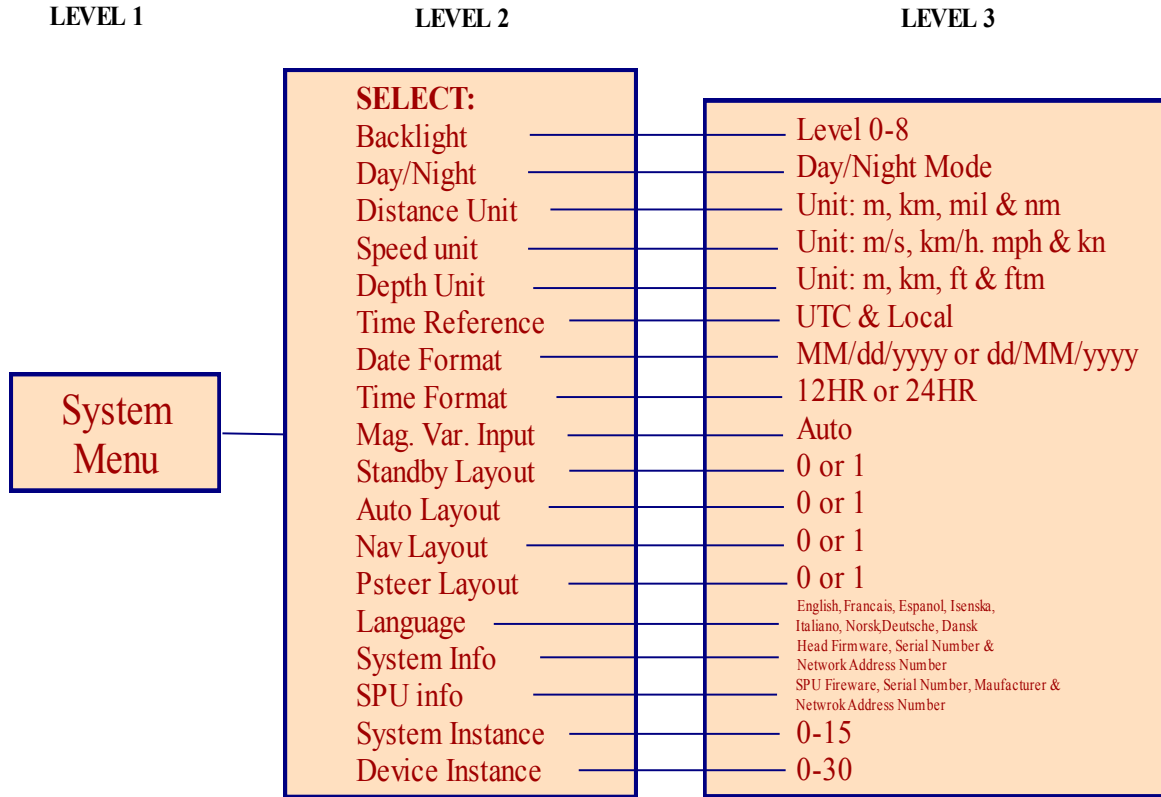

Figure 35 - System Menu Tree

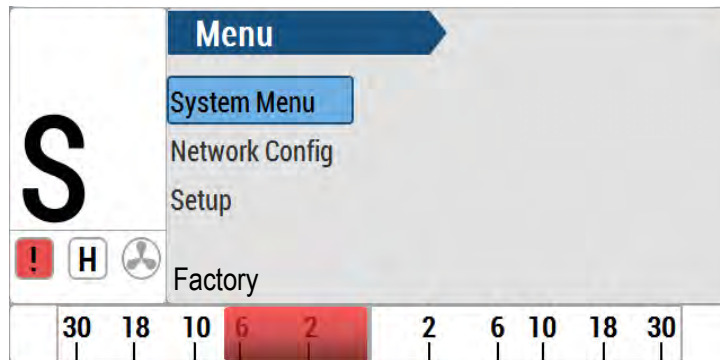

Figure 36 - System Menu Screenshot

The System menu has all of the adjustable parameters that are involved with the P4 Head Display. To access the System menu, double-press the CMD button for the MAIN Menu, and then press the TURN KNOB button to select.

Backlight

There are two modes, DAY & NIGHT that allow you to select for the most convenient and interference free viewing of the display.

Day

The backlight level is adjustable between 5% to 100%

Night

The backlight level is adjustable between 2% to 20%

Day / Night

Selects either the Day-time screen or the Night-time screen

Distance Unit

There are four Distance Unit choices: m (Meter), Km (Kilometer), mil (Miles), nm (Nautical Miles).

Speed Unit

There are four Speed Unit choices: m/s (meter/second), Km/s (Kilometer/second), mph (mile/second), Kn (Knots)

Depth Unit

There are four Depth Unit choices: m (Meter), Km (Kilometer), ft (Feet), ftm (Fathom)

Time Reference

To be defined.

Date Format

To be defined.

Time Format

UTC (Universal Time) and Local (Local Time).

Mag Var. Input

To be defined.

Standby Layout

There are 2 choices (0 or 1).

Auto Layout

There are 2 choices (0 or 1).

Nav Layout

There are 2 choices (0 or 1).

P. Steer Layout

There are 2 choices (0 or 1).

Language

There are five languages supported, English, Spanish, Italian, French, Norwegian, Danish, German, Icelandic.

System Info

This provides the following information for the P4 Head on a N2K network:

- Network addr. (Network address eg.21)
- Manufacturer (404 for ComNav devices)
- Model ID (ComNav Product Model: P4 Autopilot)
- S/W (Software Revision e.g. P4 Head 2.01)

SPU Info

This provides the following information for the P4 SPU on a N2K network:

- Network addr. (Network address eg.34)
- Manufacturer (404 for ComNav devices)
- Model ID (ComNav Product Model: P4 Autopilot)
- S/W (Software Revision e.g. P4 SPU D5.01)

Network Config menu

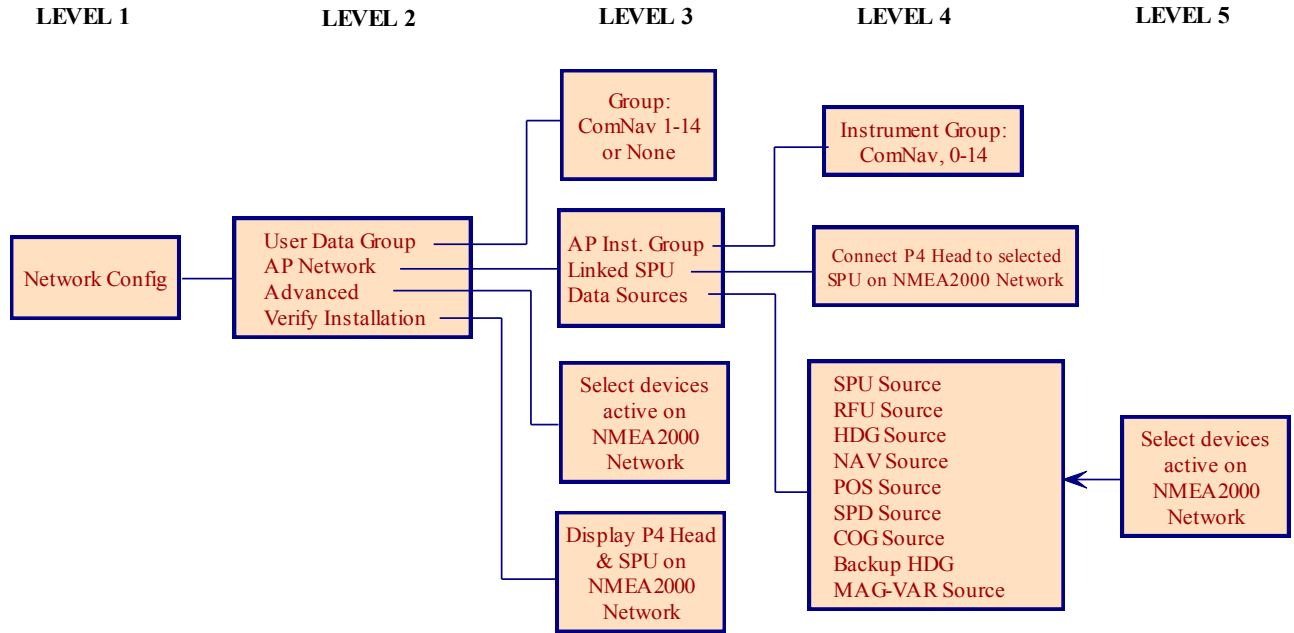

Figure 37 - Network configure Menu

The Network Config menu allow users to configure the preferred Compass Source, Navigation Source, multiple P4 SPU’s and multiple P4 Heads’ that are involved with a P4 Autopilot connecting to a NMEA 2000 Network. To access the Network Config menu, double-press the CMD button to bring up the MAIN Menu and then press TURN KNOB to select.

User Data Group

- Allows the user to change the group data field for their device.
- P4 devices with the same group data field will sync to each other. For example, if you set one P4 device with a group data field from 1 to Night mode, other P4s on the network with the same value for their group data will also change to Night mode.

AP Network

Linking all P4 devices to a NMEA 2000 network, there are three sub-menus:

Advanced (Advanced AP Inst Group)

Allows the user to configure specific devices on the network.

For most devices the only options will be “Set PGN Update Rates” and “Device Info”

- The first option will retrieve a list of PGNs’ emitted by that device and allow a user to request changes to the rate of emittance of a given PGN through a menu.
- The second option will display some basic information on the device, such as the Model ID, Serial, and Software Version

For some proprietary ComNav devices, the options “Compass Constants”, “Cal. Compass”, “Compass Settings”, “Compass Attitude Biases”, and “0183 Port Configuration” will also appear. These allow for advanced configuration of those devices.

Verify Installation

- This menu item will let you check all controllers and remotes that are current linked to the same SPU as this head.

AP Network sub-menu

AP Inst Group

There are four Distance Units: m (Meter), Km (Kilometer/second), mil (mile/second), nm (nautical mile/second)

Linked SPU

Allows users to select one SPU from multiple SPUs on the NMEA 2000 network. Please note that the screen will show all the devices on the NMEA 2000 Network, you must then select the device with “ComNav SPU.” Selecting a device which is not SPU, will show an error message.

Data Sources

Allows users to choose Heading and Navigation Data Source that are on the NMEA 2000 Network for use in AUTO and NAV mode. There are nine choices of modifiable Data Sources:

1. SPU (Signal Processor Source) Source
2. RFU (Rudder Follower Source) Source
3. HDG (Heading) Source
 - ComNav GNSS GPS Compass is under this category.
 - ComNav SSRC Compass is also under this category.
4. NAV (Navigation) Source
5. POS (Position) Source
 - ComNav GNSS GPS Compass is under this category.

6. COG (Course Over Ground) Source
 - ComNav GNSS GPS Compass is under this category.
7. SPD (Course Over Water) Source
8. Backup HDG (Heading) – Use for alarm only, not for a backup in case of lost heading.
9. Mag-Var Source

NOTE: By default, the P4 Autopilot will select all of the above Data Sources automatically available on the NMEA 2000 network. If there is more than one same Data Source (PGN) on the network, the P4 Autopilot will pick the first that is available. If there is none available, the P4 Autopilot will do nothing. It is up to the user to confirm they are using the correct data for navigations.

Setup Menu

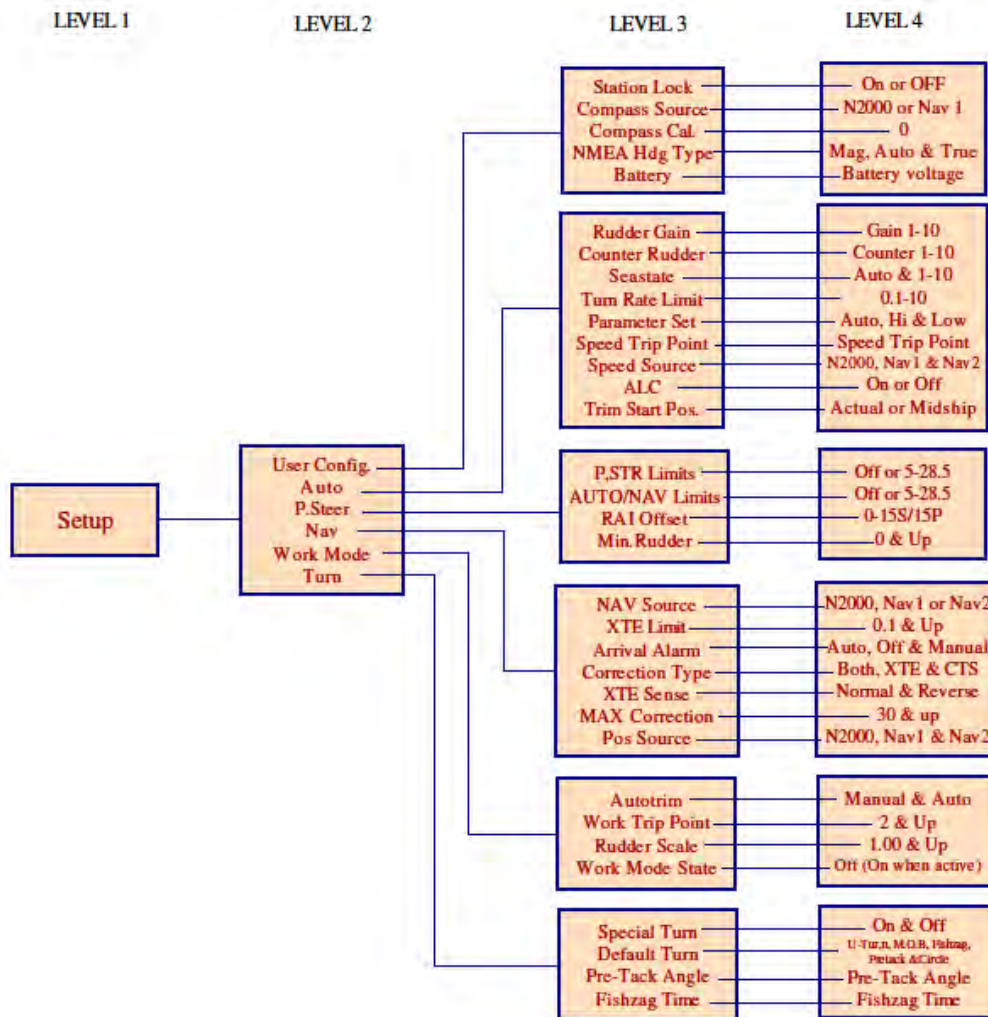
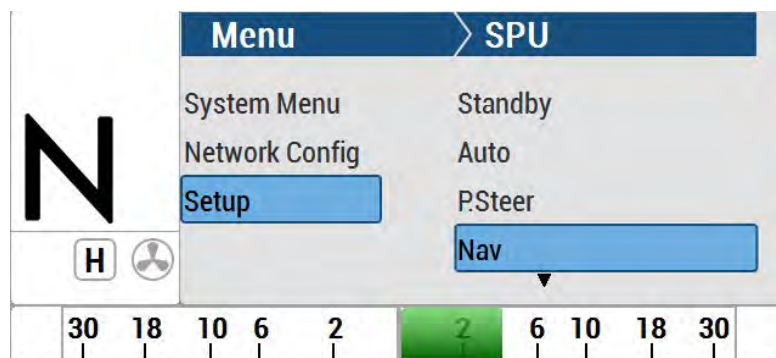

Figure 38 - Dockside Menu Enter from System Menu

Set up the adjustable parameters for use in “**STANDBY (User Config.), Power Steer (P. Steer), AUTO, NAV, Work mode & Turn**” modes which are stored in the P4 SPU. Please see the parameter descriptions under “Basic & Advanced Operation” for proper adjustments.



Setup procedures

For typical ComNav P4 NMEA 2000 system - P4 Head and SPU with NMEA 2000 Compass and Rotary Feedback, do the following:

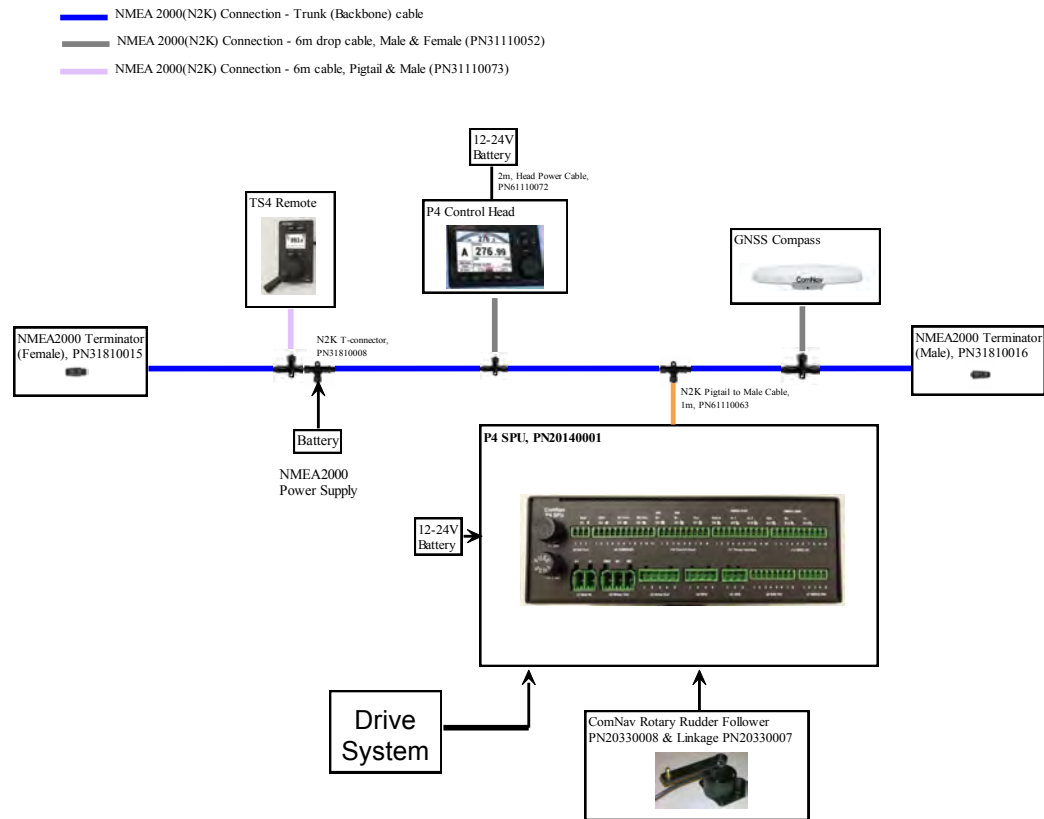
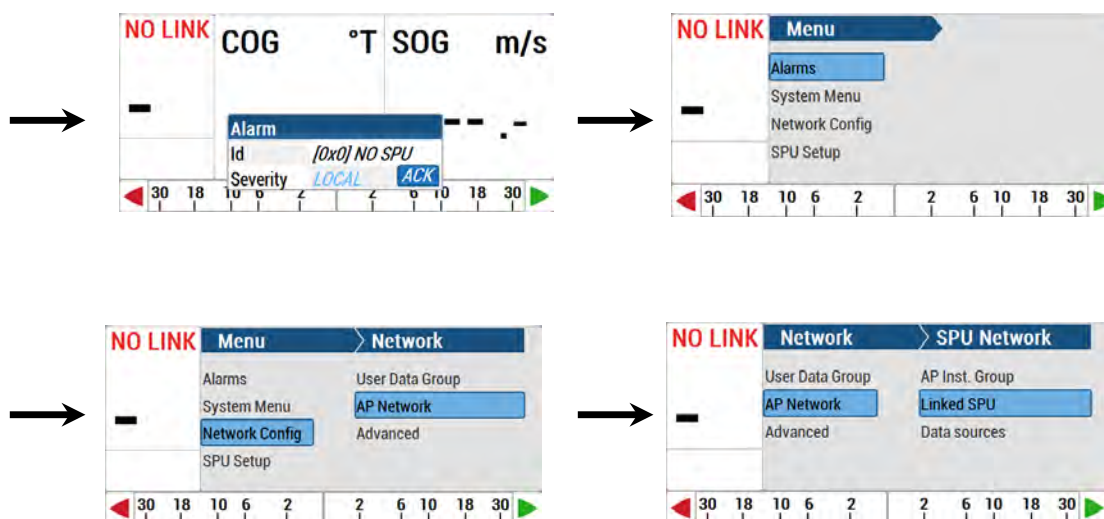

Figure 39 - P4 Setup System

The ComNav P4 system is designed with safety messages for all situations requiring alerts, and users must acknowledge the alarm messages if and when they occur.

When the unit is first connected to the NMEA 2000 network, there will be two possible screens with alert messages. One is “No Link” to SPU. The other is “Faulty Head.”

For “No Link” to SPU:



Repair and Reset:

1. Make sure the NMEA 2000 wires are connected to the SPU properly.
2. Press the Enter button to acknowledge alarm
3. Press and hold the CMD button to take control
4. Double Press the CMD button to “Main Menu”
5. Select Network Config
6. Select AP Network
7. Press Enter (TURN KNOB) button to acknowledge the Warning Message - press ENTER to dismiss”
8. Select Linked SPU
9. Select the SPU serial number
10. Press Enter to select the SPU. Now the Control Head and the SPU are connected together and the Remote is in control.
11. Press the CMD button to go back to the previous screen.
12. Press and hold the CMD to take control of the Head.
13. Press the CMD button a few times to get back to “STANDBY” screen, “S” on the left lower corner as below.

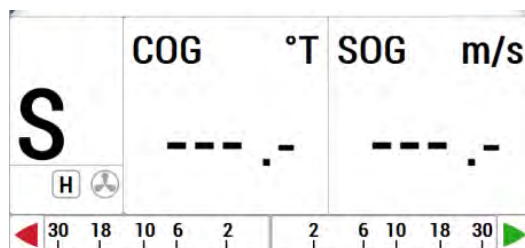

For “Faulty Head”

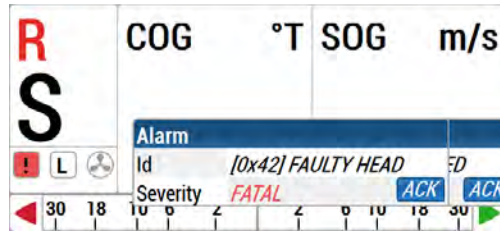

The “NO COMMAND HEAD” alert identifies a connection failure to the SPU upon initial start-up. The “Compass error” alert occurs when the SPU can’t identify the Compass source. To correct either of these alerts, do the following:

1. Press “Enter” (brought up by clicking/single press the TURN knob) to acknowledge the alarm message.
2. Press and hold the “CMD” button to take control. The “NO COMMAND HEAD” and “Compass Error” messages will disappear.

NMEA 2000 Compass to system

As explained in First time power up in 4.1.4 System Setup, the autopilot will automatically link to a compass in the network. If for any reason the system does not link to a NMEA 2000 compass device, you can manually select the NMEA 2000 compass device using the Main MENU, see below for guidance.

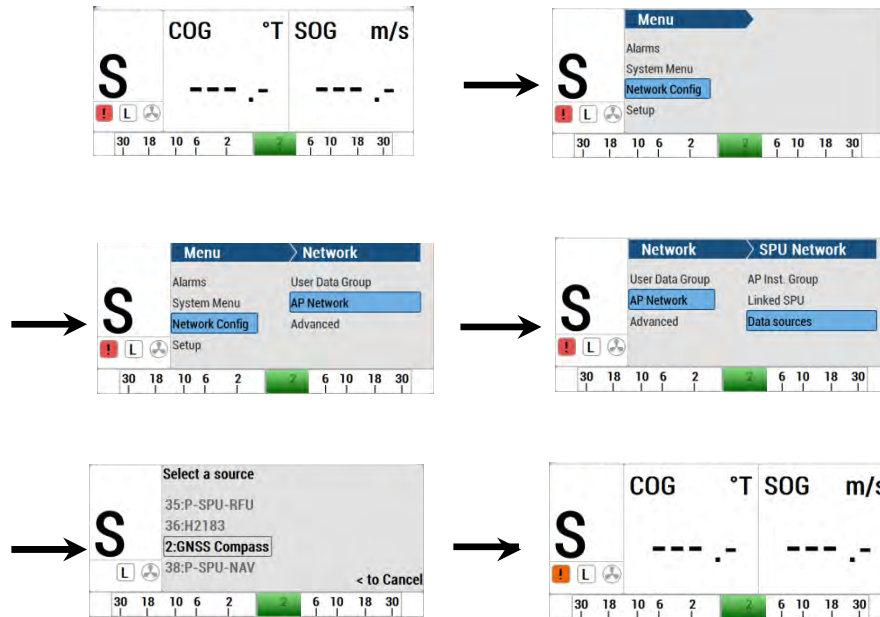

To configure NMEA 2000 Compass as HDG (Heading Source) and/or POS (Position Source)

1. Press Enter to acknowledge the alarm
2. Press the CMD button to take control
3. Double Press the CMD button to bring up the menu.
4. Select Network Config
5. Select AP Network
6. Press the ENTER button to acknowledge Warning Message>Select Data Source
7. Select HDG (Heading) Source, select POS (position) Source
8. Select the GNSS serial number
9. Press ENTER to select the compass.
10. Press the Menu button to go to previous screen
11. Press the CMD button to take control of the Head
12. From the STANDBY mode screen, the compass reading should show “**HDG** XXX.X°T” where XXX.X is the True Heading from N2K network

Rotary Feedback

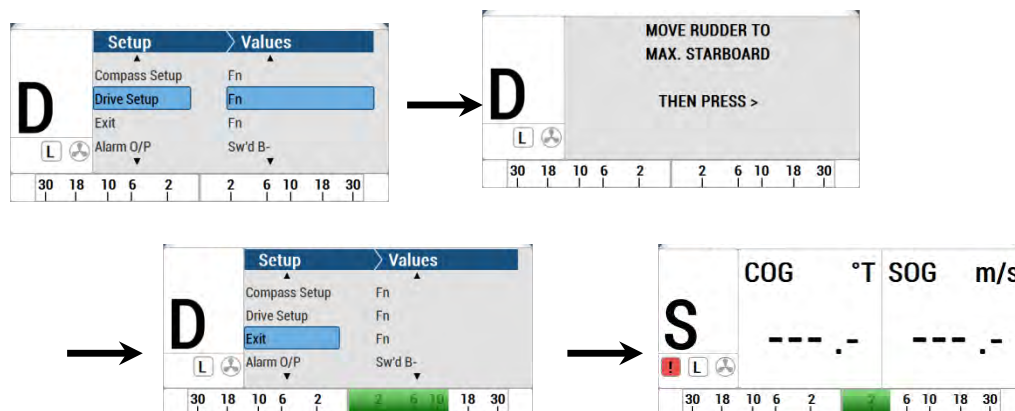

To configure Rotary Follower unit to system

1. Enter SPU DOCKSIDE Menu: power-down & up the system, press LEFT & RIGHT ARROW KEYS <> at the same time when the instruction is on the screen.
2. Note that the “D”(Dockside Setup Menu) on the left side of the screen
3. Select Drive Setup
4. Follow instructions to move rudder to finish setup.
5. After Dockside, the screen returns to “Drive Setup”
6. Select “Exit” on the Dockside Setup Menu, DO NOT use the MENU button to go to the previous screen.
7. On the left side of the screen should be “S” in STANDBY mode
8. To verify, press P.STR button to activate the rudder, and the rudder indicator on the screen should show accordingly

Standby Menu

The Standby menu consists of a number of items that have a general bearing on how the autopilot operates. To access the Standby menu, double-press the red STANDBY/ON/OFF button. * To get the full menu, it must be Standby mode.

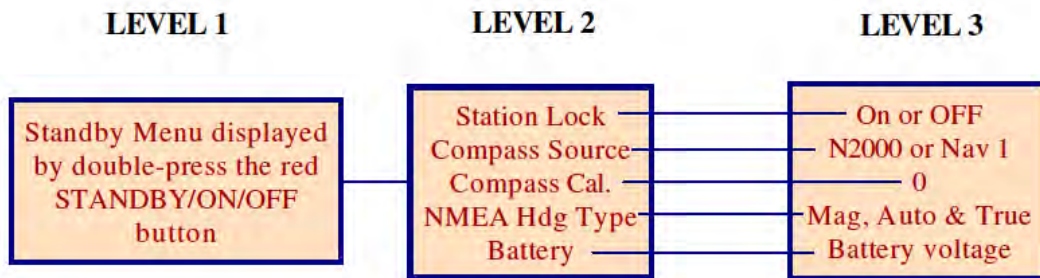

Figure 40 – Standby Menu

User Config		Values
Station Lock		Off
Compass Source		Analog
Compass Cal		0
NMEA Hdg Type		Mag
Battery		13.5

30	18	10	6	2	2	6	10	18	30
----	----	----	---	---	---	---	----	----	----

Station Lock

The P4 system can have many Control Stations limited only by the NMEA 2000 network.

One of these Control Stations is always the main control, and the others are simply repeater stations. You can take command with any of the repeater stations by simultaneously pressing the PORT and STARBOARD ARROW buttons on the repeater.

However, to prevent an unauthorized person from doing this, the main Control Head can lock out all of the others. Station Lock must be changed to Unlock before the repeater stations can take command. For more detail, refer to **Station Lock/Unlock section of this manual**.

Compass Source

There are a number of separate inputs for the many different types of compasses that may be used with the P4 (N2000, Analog, Nav1 and Nav2) system. You may choose to have more than one type connected at any given time. This menu item allows you to switch from one to another whenever the operator chooses.

The selected input can be the same one used for the Navigation data source and/or the Speed source.

The next table summarizes all available input ports in P4 SPU.

Source	Available port options	Menu to change the port	Accessed through when P4 is in command
Compass Source	NMEA 2000, Analog compass port (fluxgate and magnetic), NAV1, NAV2	SPU User menu	Double click STBD button
Speed	Nmea 2000, NAV1, NAV2	SPU AUTO menu	Double click AUTO button
Navigation	Nmea 2000, NAV1, NAV2	SPU NAV menu	Double click NAV button
Position			

Table 2 - SPU Available Input Ports

Compass Cal - Compass Calibration

This feature allows you to synchronize the compass on the autopilot with an external source. Simply turn the COURSE CHANGE knob until the Compass Cal value reads the same as your reference source.

*NOTE: For safety reasons, Compass Cal may not be adjusted in **AUTO** or **NAV** modes, so it does not appear if the Standby menu is entered in one of those modes.*

NMEA Hdg Type

If you use NMEA2000, NAV1 or NAV2 for your heading source, you have the option to select True or Magnetic as your heading reference. This is useful if your NMEA 0183 device output both HDT and HDM, and you want to use the magnetic heading. If you select Auto, the autopilot will select the heading reference based on its internal priority order described below.

For NAV1 or NAV2, heading may come from HDG, HDT, or HDM in high to low priority order.

For NMEA 2000 PGN 127250, the True or Magnetic reference type is used.

Battery This is a read-only display that cannot be changed. The number shown is the battery voltage as measured at the Signal Processor Unit.

Power Steer Mode

To enter POWER STEER mode, press and hold the **P.STR** button for approximately half a second, until the large “P” mode indicator appears in the upper left corner of the display (see [Figure 41](#)).

In this mode, the display shows the actual compass heading and the rudder angle. The PORT and STARBOARD ARROW buttons are used to control the rudder. Press one or the other to move the rudder in that direction. The rudder will keep moving for as long as the button is pressed until it gets to the physical rudder limits.

You can limit the maximum amount of rudder travel in POWER STEER mode by turning on the Power Steer limits. Turning on these limits, and adjusting them to suit, is done in the Power Steer menu. The COURSE CHANGE knob can also be used to move the rudder in POWER STEER mode. Each “click” of the knob will move the rudder a finite yet equal amount.

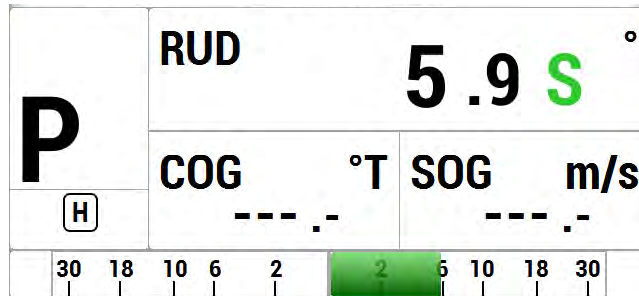

Figure 41 – Typical Power Steer Mode Screen

Power Steer Menu

The Power Steer menu contains the mechanical steering parameters (which are common to all modes). To access the Power Steer menu, double-press the **P.STR** button.

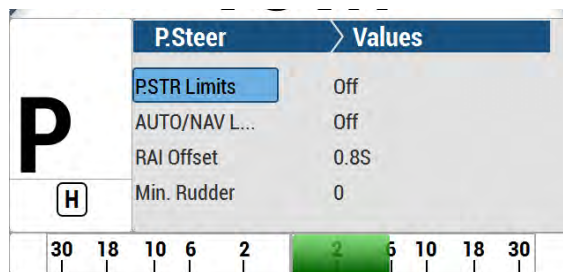
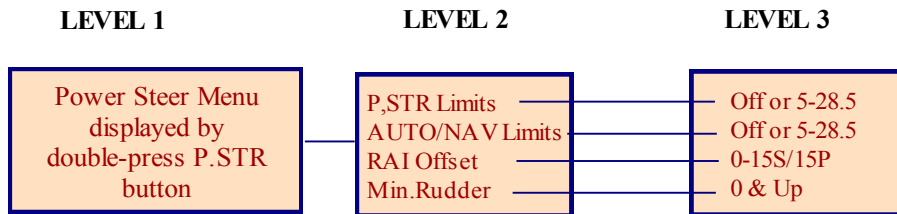

Figure 42 – Power Steer Menu

Stdbby/P. Str Limits - Power Steer Rudder Limits

When you initially set up the P4 system, you will move the rudder from hard over port to hard over starboard so that the autopilot can measure these positions. These mechanical hard over positions are known as the “physical limits”, beyond which the rudder simply cannot be turned. However, you can artificially limit the rudder travel through the autopilot software.

To do so, set the Power Steer Limits to the number of degrees port and starboard that you would like to limit the rudder movement to. These rudder limits will be in effect whenever the autopilot is in POWER STEER mode, and during all Dodge and Jog Lever turns. The minimum setting is 5°; the maximum is the same as the physical limits measured in Dockside Setup. Setting the limits to “Off” means that the full range – up to the physical limits – will be allowed. The range beyond the selected limits will be shown on the bottom bar of the Rudder Angle Indicator display during normal operation.

NOTE: SPU firmware versions before 3.05 allowed the rudder to be moved in Standby mode with a Jog Lever. However, this feature was disabled in that version and onwards, for safety reasons. The parameter name in the menu was not changed, however.

Auto/Nav Limits

The Auto/Nav Limits are essentially the same as the Power Steer Limits detailed above, but they are in effect only when the autopilot is in **AUTO** or **NAV** modes.

RAI Offset

The Rudder Angle Indicator (RAI) display at the bottom of the autopilot display may require a slight offset adjustment in order to read zero degrees when the vessel is moving in a straight line. This is a fairly common scenario and may be due to vessel loading or design, rudder design or function, or the installation of the Rudder Feedback Unit. For example, if the vessel is traveling in a straight line, but the RAI reads 2° to starboard, adjust the RAI Offset to port so that the RAI display reads zero.

Auto Mode

In AUTO mode, the autopilot will steer the vessel on your desired Heading. To enter AUTO mode, press and hold the AUTO button for about 1 second, until the large letter 'A' appears in the upper left portion of the display (see [Figure 43](#)).

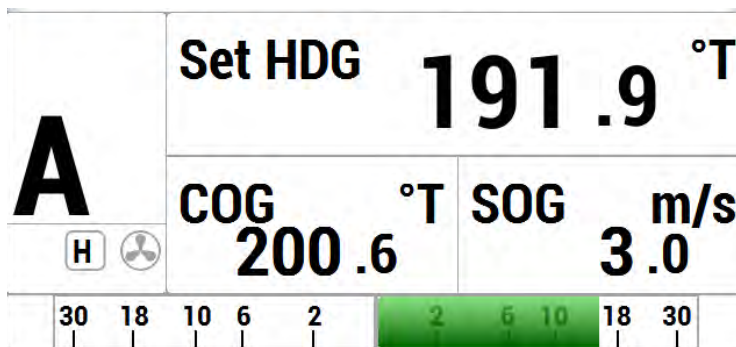

Figure 43 – Typical AUTO Mode Screen

The vessel's current actual heading is shown in large letters in the middle of the LCD screen, with the source and type. Your Desired Heading – also known as the “Commanded Heading” – is shown in smaller digits at the top-centre of the screen.

When you first enter AUTO mode, the autopilot will use the heading that the boat was on at the moment the mode was entered as the initial Commanded Heading. To change the Commanded Heading, use the COURSE CHANGE knob:

- A clockwise turn will result in an increase of the Heading.
- A counter-clockwise turn will decrease the Heading.
- One 'click' will change the Heading by 1 degree.
- A quick spin of the knob changes the Heading by 10 degrees.

The autopilot will then bring the boat around to the new Commanded Heading at no more than the rate of turn specified for Turn Rate in the Auto menu. The actual Heading shown in the display will gradually change to match the Commanded Heading.

Pick up the current heading as the course to steer

When you make a course change, sometimes you may want to stop the turn before the heading reaches the set heading. Press AUTO button again when you already in AUTO mode will set the course to the heading at the moment of button press.

Notes on AUTO Mode If you need to, you can quickly “dodge” around obstacles, and automatically return to your original Commanded Heading when the boat is clear of the obstacle, without having to turn the COURSE CHANGE knob. See the **Dodge and Jog Steering Turns** section for more information.

You can limit the maximum amount of rudder travel in AUTO mode by turning on the Auto/Nav rudder limits. Turning them on, and adjusting them to suit, is done in the **Power Steer** menu.

The autopilot has an automatic Off-Course Alarm that will be activated should the boat fall off the Commanded Heading by more than 20°. There is a 30 second delay on this alarm.

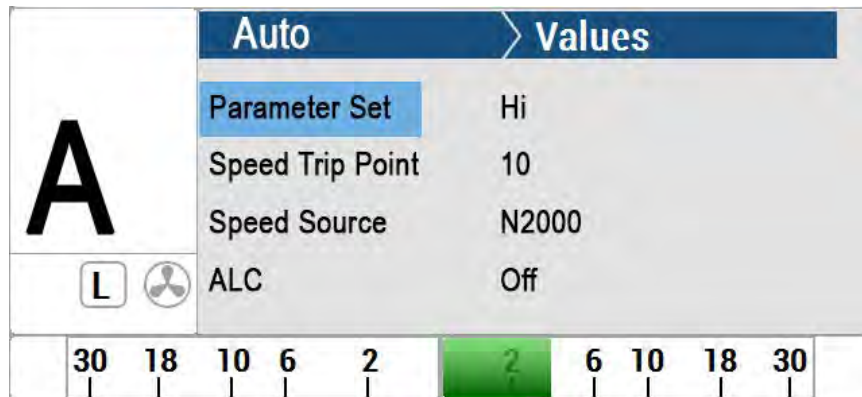
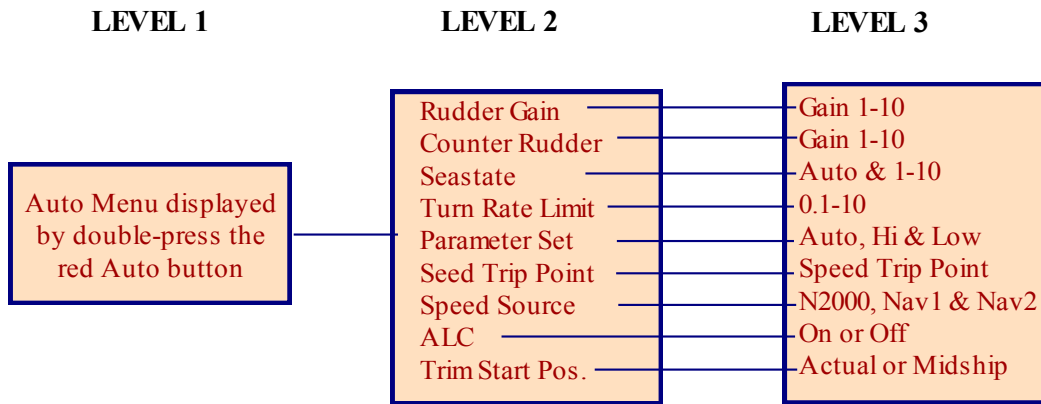

Figure 44 - Typical Auto Menu Screen

Hi & Lo Speed Rudder Gain

Counter Rudder is a measure of how much rudder is applied for a given rate of change in course error. If the course error is increasing, the counter rudder adds to the rudder correction, and if the course error is decreasing, the counter rudder subtracts from the rudder correction applied.

Like Rudder Gain, there are two numbers shown; one for LO speed, and one for HI speed. The parameter values do not have any units. The following diagram provides a general guide to setting Counter Rudder:

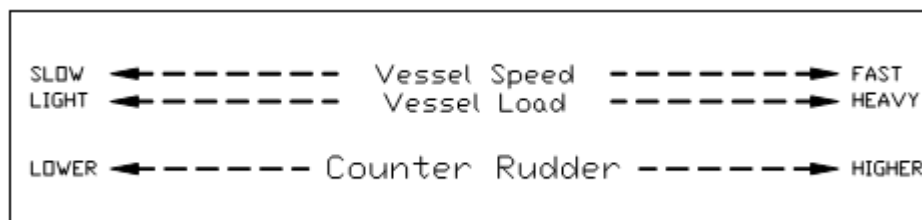

Figure 45 – Guidelines for setting Counter Rudder

Seastate

The Seastate control tells the autopilot how much deviation from the set course allow before taking corrective action. This deviation is also called “Yaw.”

Seastate should be set according to sea conditions. As conditions worsen, the Seastate setting can be increased. This can result in slightly decreased steering performance, but will improve and reduce the amount of rudder movement and strain on the steering system.

This parameter’s units are in total degrees on either side of the set course, so a value of 1 will allow the vessel to change up to 0.5° of heading on either side of the set course before bringing it back on course. The maximum value is 10°.

There is also an Automatic Seastate Control feature that will monitor and adjust the Seastate setting for you. To activate this, highlight “Seastate” in the menu and turn the COURSE CHANGE knob counter-clockwise until the value reads “A.”

There are two Seastate settings; one is for low speed operations (LO) and one is for high speed operations (HI).

Turn Rate

Varying the Turn Rate parameter controls the maximum rate at which the vessel may make a course change (in AUTO or NAV modes), return to its original heading after a dodge manoeuvre, or execute a Special Turn. Factors such as speed, load, hull characteristics and weather conditions may limit the maximum achievable turn rate.

This parameter’s units are in degrees per second. Up to 1.5 °/sec, the value increments by 0.1° per click of the COURSE CHANGE knob; between 2.0 °/sec to the maximum of 20.0 °/sec, it changes by 1° per click.

There are two Turn Rate settings; one is for low speed operations (LO) and one is for high speed operations (HI).

Parameter Set

The P4 gives you the ability to store two sets of steering parameters, labelled “Hi” (high) and “Lo” (low). This allows for best performance under varying vessel speeds and/or loading conditions.

The autopilot can be set manually to use either the Lo or the Hi settings. There is also a selection for “Auto”. If Auto is chosen, the autopilot will automatically switch from Hi to Lo, or vice-versa, depending on the vessel’s speed. For Auto to work, the autopilot must be connected to an NMEA 0183 Navigation System that outputs speed information. The Speed Trip Point discussed later, governs the point at which the switch is made.

When the P4 is in AUTO or NAV mode, it always indicates which steering parameter set is in effect. This is shown just to the left of the Rudder Angle Indicator, and consists of a small box shape with either H for Hi or L for Lo in it. If the parameter is set to Auto, then the word “AUTO” also appears in the box (**Figure 46**).

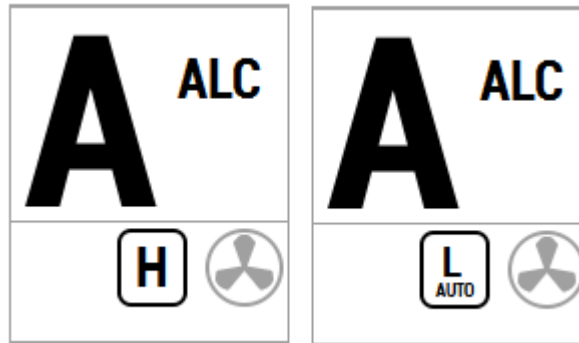

Figure 46 – HI and LO Speed Icons (Left of Rudder Angle Indicator)

Speed Trip Pt – Speed Trip Point

The Speed Trip Point governs the point at which the autopilot automatically transitions from the Lo steering parameters to Hi. For an automatic transition to take place, the Parameter Set must be set to “Auto.”

Speed Source

The P4 can obtain information about the vessel’s speed from a variety of sources that provide NMEA 0183 data outputs, at either the NAV1 or NAV2 inputs on connector **J9**. This menu item is used to select which of the two inputs the autopilot will use.

The selected input can be the same one used for the Compass source, and/or the Navigation data source.

ALC - Automatic Leeway Correction

The P4’s Automatic Leeway Correction (ALC) feature is turned on or off with this parameter. It is active only in AUTO mode. See the **Following a Track** section for more information.

Thruster Assist or Thruster Gain

If the Thrust Type in the Dockside menu is not “None”, these two functions will be available in the menu.

Thruster Assist sets the maximum speed at which the Thruster Assistance feature will be active. This parameter can be varied in 0.5 knot steps up to 7.0 knots, or can be set to Off. When Thruster Assist is set to some value other than Off, the autopilot will use the thruster(s) selected to assist the vessel in maintaining a course, or turning onto a new course.

Note: this feature requires a speed sensor in the system. When Thruster Assist is set Off, the autopilot will not activate thruster assistance feature. Thruster Gain is used to adjust how aggressive you want the thrusters to be when using automatic Thruster Assistance feature. If On/Off thrusters are used, the Gain setting primarily affects how long the thruster is activated. If other thrusters are used, the Gain setting primarily affects the minimum voltage or current of the thruster outputs.

NAV Mode

In NAV mode, the P4 Advanced Autopilot system can use steering information from an external NMEA 0183 Navigation System, to steer to a destination, or along a route of waypoints leading to a final destination.

In NAV mode, the P4 uses its own compass (or the Navigation System) as its primary source of heading for course keeping, while the steering data received from the Navigation System is used to calculate the commanded heading to the destination or next waypoint.

To activate NAV mode:

- Turn on your Navigation System and activate a waypoint.
- Press the NAV button on the Control Head until the letter “N” appears in the upper left portion of the display, indicating NAV mode has been initiated (**Figure 47**).
- The Waypoint ID, Range, Bearing, and cross-track error (XTE), as provided by the Navigation System will be shown on the Control Head display.

NOTE: some Navigation Systems do not provide all of this information. In such cases, the display will show dashes (- - -) or “NONE” in place of any missing data.

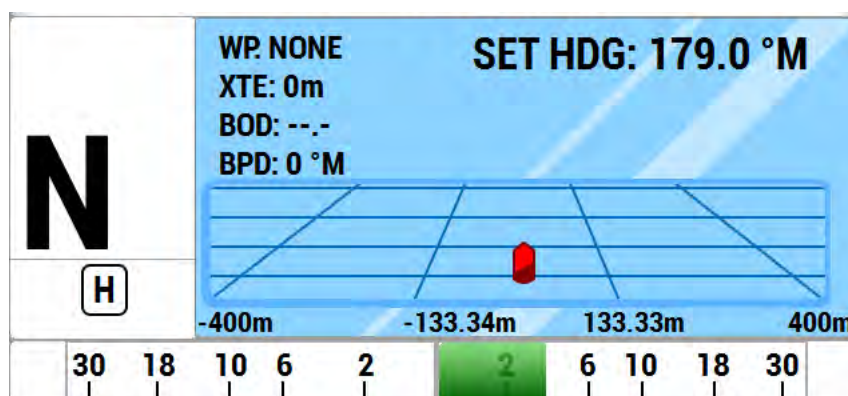
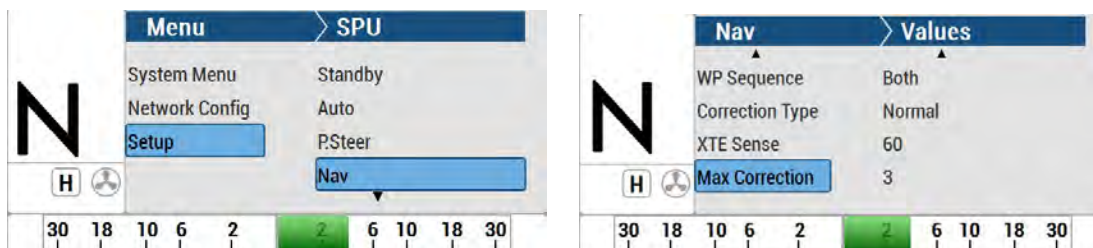

Figure 47 – Typical NAV Mode Screen (Normal Display)

In NAV mode, you can quickly “dodge” around obstacles, and automatically return to your original Track. See the **5.6 Dodge** and **Jog Lever Turns** sections for more information.

You can limit the maximum amount of rudder travel in NAV mode by turning on the Auto/Nav rudder limits. Turning them on, and adjusting them to suit, is done in the Power Steer menu.

The P4 has an automatic Off-Course Alarm that will be activated should the vessel fall off the commanded course in NAV mode, by more than 20°. There is a 32 second delay on this alarm.



Nav Menu

The Nav menu contains a number of parameters used when operating the autopilot in NAV mode. To access the Nav menu, double-press the NAV button.

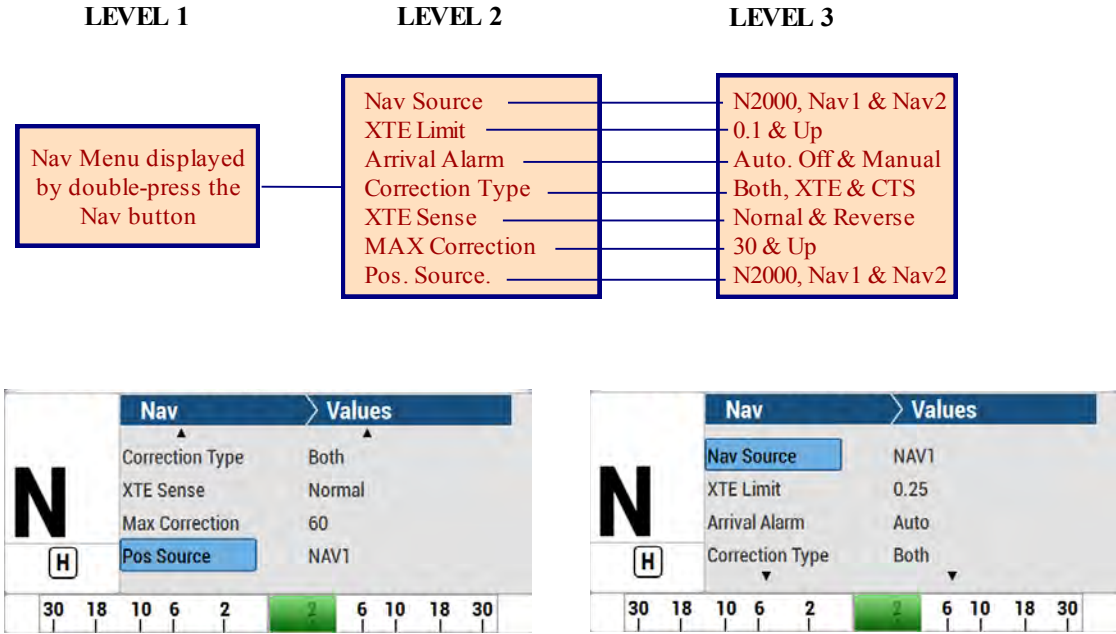

Figure 48 – Nav Menu

Nav Source

Set the Nav Source to the SPU's input connection (NAV1 or NAV2) that the external Navigation System is connected to. The autopilot will then look at that input when in NAV mode to obtain the bearing and course-to-steer information.

The selected input can be the same one used for the Compass source, and/or the Speed source.

XTE Limit - Cross-Track Error Limit

The autopilot will raise an alarm while in NAV mode if the vessel's cross-track error exceeds the limit set here.

WayPt. Arrival - Waypoint Arrival

When the vessel arrives at a waypoint or the end of a route, a special "arrival" message is sent to the autopilot from the Navigation System. This menu item tells the P4 how you want to deal with the arrival message.

Manual (manual sequencing):

- Displays "Waypoint Arrival" on the Control Head screen, accompanied by an audible alarm. The autopilot will maintain its present course and NOT automatically turn the vessel to the next waypoint in a route until the alarm has been acknowledged by pressing the **ENTER** button.

Auto (automatic sequencing):

- Displays “Waypoint Arrival” on the Control Head screen, accompanied by an audible alarm. However, the autopilot will automatically turn the vessel to the next waypoint in a route even if the alarm is not acknowledged by pressing the **ENTER** button.

Silent (silent sequencing):

- Automatically turns the vessel to the next waypoint in a route.

Caution! *No waypoint arrival alarm will be displayed. Choose this option if your Navigation System has its own waypoint arrival alarm that cannot be turned off, and you do not wish to acknowledge the same alarm on multiple devices.*

Correction

If the vessel is not directly on track when in NAV mode, there are three ways it can arrive at the waypoint:

Setting	Description	Comments
CTS	Course-To-Steer	The autopilot picks out the Course-To-Steer information from the Navigation System. This results in a straight-line course to the destination waypoint. Cross-track error, while displayed, is not used by the autopilot.
XTE	Cross-Track Error	The autopilot steers from its current heading so as to minimize Cross-Track Error. No Course-To-Steer information from the Navigation System is used.
Both	Course-To-Steer plus Cross-Track Error	The autopilot steers a modified course taken from the Navigation System's Course-To-Steer. The amount of modification is proportional to the amount of Cross-Track Error. This method is generally best for normal usage.

Table 5 – NAV Mode Correction

XTE Sense - Cross-Track Error Sense

Cross track error (XTE) contains two pieces of information. First, it contains the *amount* of the error. Secondly, it gives information about the ‘sense’ of the error (i.e. whether the vessel is to the left or the right of the line between the beginning and ending waypoints).

The NMEA (National Marine Electronics Association) has specified how a cross track error should be identified; a left indicator (L) in the data sentence means the vessel should steer to the left and a right indicator (R) means the vessel should steer to the right.

However, some manufacturers of GPS, chart-plotters, and other navigation devices and systems have used the left indicator to mean that the vessel is to the left of the line, so the vessel should steer to the right, and the right indicator to mean that the vessel is to the right of the line, so the vessel should steer to the left,

Because of this confusion, the P4's handling of XTE can be switched from "Norm" (normal) to "Rev" (reverse). In "Norm", the autopilot will respond normally to the sense of the cross-track error. In "Rev", the autopilot will respond in the opposite way in response to the same information.

Max Correction

When activating pre-stored routes with a large amount of initial cross track error, the autopilot will steer the boat at almost 90° to the track, in order to get back on track as fast as possible. In certain circumstances, this can appear as though the vessel is moving away from the desired waypoint. Setting Max Correction to something less than 90° can minimize this phenomenon, yet will get you back on track less quickly.

Commanded Heading Displayed

The commanded heading shown on the display in NAV mode may not be the same as the bearing given by the Navigation System. This is because there are three different methods that the P4 can use to process and react to the navigation data from the Navigation System. You select which method you want the P4 to use by specifying "XTE", "CTS", or "Both" for the "Correction" parameter in the Nav menu.

Correction set to CTS – Steering a Direct Bearing

In this method, Cross-Track Error is not factored into the calculation that the P4 uses to determine the heading to steer. The autopilot therefore steers directly to the destination waypoint, as depicted in [Figure 49](#):

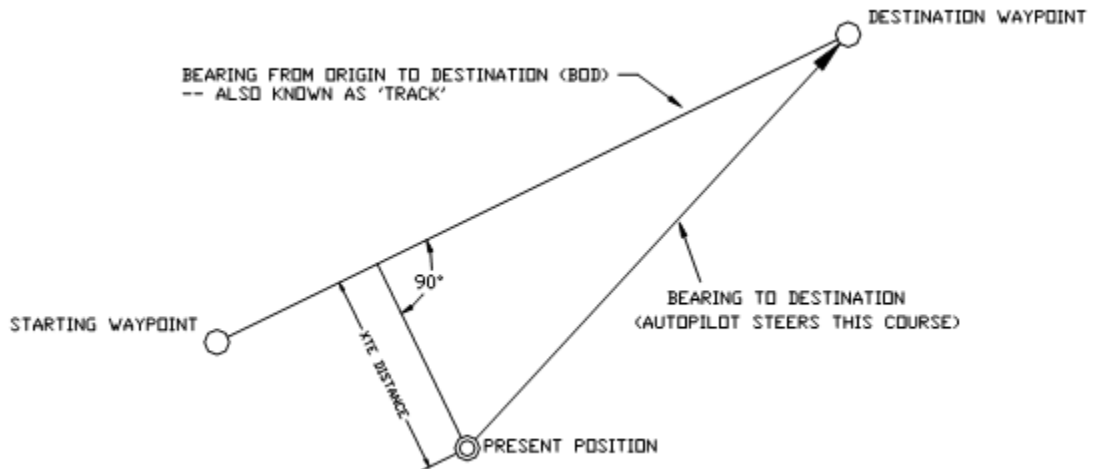

Figure 49 – Steering with Correction set to CTS

Test this out to be familiar with it, by performing the following steps:

- 1) Change "Correction" in the Nav menu to "CTS"
- 2) Make sure the Navigation System is turned on and that a waypoint is programmed in.
- 3) Switch the autopilot to **STANDBY** mode and manually steer the vessel away from the waypoint track by a few hundred meters or more.
- 4) Place the P4 into **NAV** mode by pressing and holding the NAV button until the unit beeps and the letter "N" appears in the upper left portion of the display.
- 5) Observe the commanded heading on the P4 display. It should match the bearing reported by the Navigation System.

Caution! *Be sure to maintain a sharp lookout to ensure that there are no obstacles between the vessel and the destination when steering directly to a waypoint.*

Correction set to XTE – Cross-Track Error Steering

Cross-track error is the perpendicular distance from the track to the vessel's position.

When using Cross-Track Error Steering, the autopilot initially steers on its present heading, and monitors the Cross-Track Error reported by the Navigation System. The autopilot changes the heading so as to minimize the cross-track error.

If the initial cross-track error is large, the autopilot will steer a course almost perpendicular to the original track, so as to get back on the track as quickly as possible.

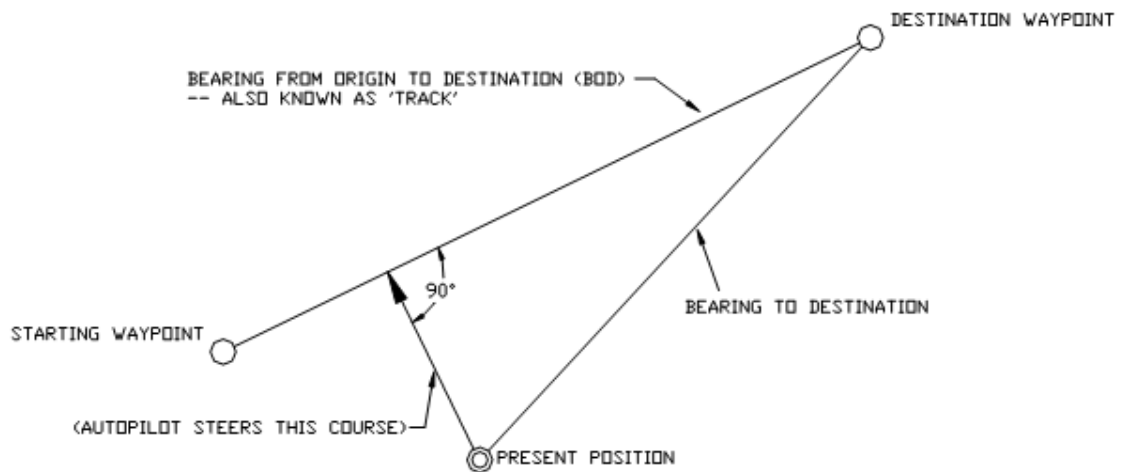

Figure 50 – Steering with Correction set to XTE

Test this out so as to be familiar with it by performing the following steps:

- 1) Change “Correction” in the Nav menu to “XTE”
- 2) Make sure the Navigation System is turned on and that a waypoint is programmed in.
- 3) Switch the autopilot to **STANDBY** mode and manually steer the vessel onto the track.
- 4) Place the P4 into NAV mode by pressing and holding the NAV button until the unit beeps and the letter “N” appears in the upper left portion of the display.
- 5) Observe the vessel's heading and the cross-track error. The autopilot should be steering so as to minimize cross-track error.

The course steered when Correction is set to “XTE” may not be the most efficient in terms of overall distance traveled.

NOTE: If the vessel seems to be continually falling off course away from the track, change the “XTE Sense” (cross-track error sense) in the Nav menu from “Norm” (normal) to “Rev” (reverse) and observe any performance differences.

If there is a large cross-track error, the autopilot may overshoot the intended track. This is a function of turn rate, vessel speed, and position updates received from the Navigation System. For best performance, it is always best to minimize any cross-track error before putting the autopilot into NAV mode.

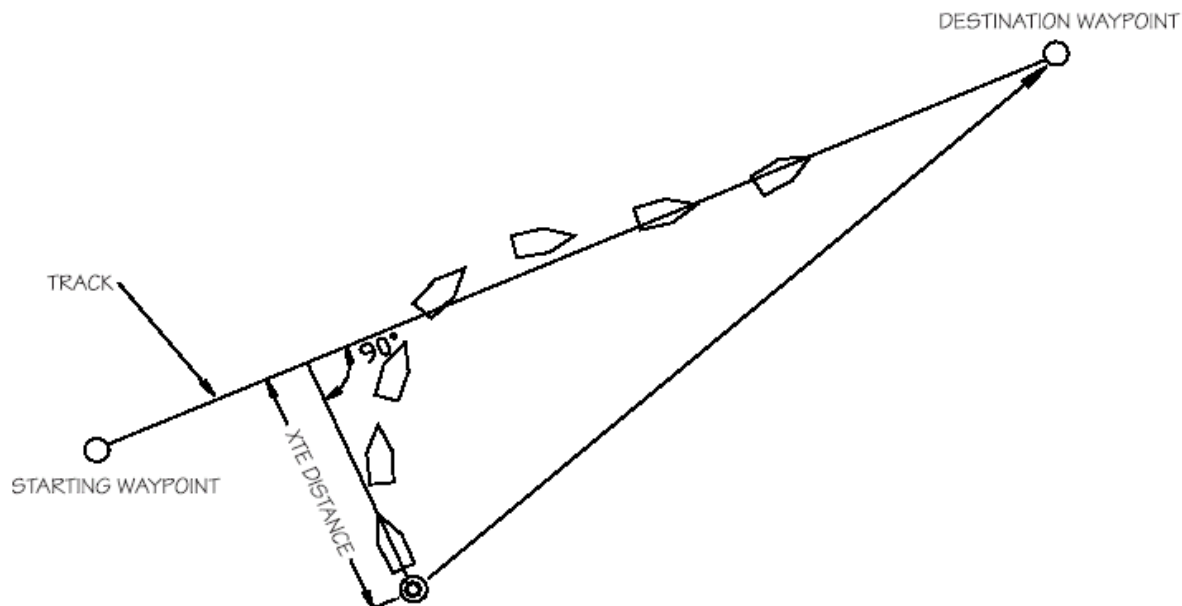

Figure 51 – Response of Vessel to a Large Cross-Track Error

The total number of degrees that the autopilot will correct the heading received from the Navigation System as it tries to bring the vessel back on track is limited to the value set for “XTE Limit” in the Nav menu.

Caution! *Be sure to maintain a sharp lookout to ensure that there are no obstacles between the vessel and the original track.*

Correction set to Both – Steering To/Along a Track

In this method shown in [Figure 52](#), the P4 will bring the vessel onto the track as smoothly and efficiently as possible. It does this by combining aspects of steering, using cross-track error, bearing from original to destination, and bearing directly to the waypoint.

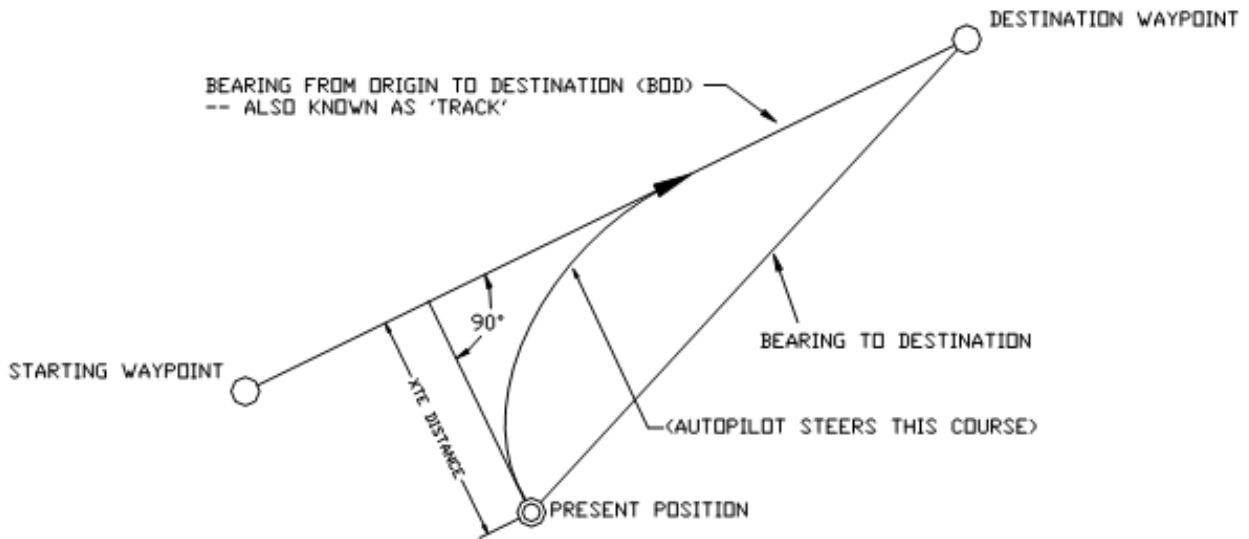

Figure 52 – Steering with Correction set to Both

When steering along a track, the P4 tries to minimize cross-track error by steering to a heading that lies between the perpendicular to the track and the destination waypoint. The farther you are off track, the closer to the perpendicular the heading will be. As you come closer to the track, the heading of the vessel will change closer to the heading of the track. When you are on-track, the vessel's heading and the track heading will be identical.

The total number of degrees that the autopilot will correct the heading received from the Navigation System as it tries to bring the vessel back on track is limited to the value set for "Max Correction" in the Nav menu.

You can test out how well the P4 steers along a track by following these steps:

- 1) Make sure the Navigation System is turned on and that a waypoint is programmed in. Usually this means selecting a waypoint from a list and pressing the "GOTO" button.
- 2) Steer the boat close to the waypoint track.
- 3) Put the P4 in NAV mode by pressing and holding the NAV button until the unit beeps, and the letter "N" appears in the upper left portion of the display.
- 4) Observe the vessel's response for several minutes (if the vessel seems to be continually falling off course away from the track, change "XTE Sense" (cross-track error sense) in the Nav menu from "NORM" (normal) to "REV" (reverse) and observe any performance differences).
- 5) Verify correct operation by steering back to the original track and then putting the autopilot into NAV mode again.
- 6) Observe the vessel's response as before. If the vessel is wandering back and forth but there are no alarms on the autopilot or Navigation System, the most common cause is poor signal quality in the sensor or antenna wiring of the Navigation System.

This may be due to:

- Improper grounding
- Electrical noise generated in the vessel (alternators, power packs, etc.)
- Poor antenna location

Refer to the Navigation System's manual for signal quality measurements, and ideas on making improvements.

Alternate Navigation Display

An alternative display is available for NAV mode. To access this display, enter NAV mode by pressing the NAV button until the letter “N” appears in the upper left portion of the display. Release the button, and then press the NAV button again. The display will change to a “highway” representation as shown below:

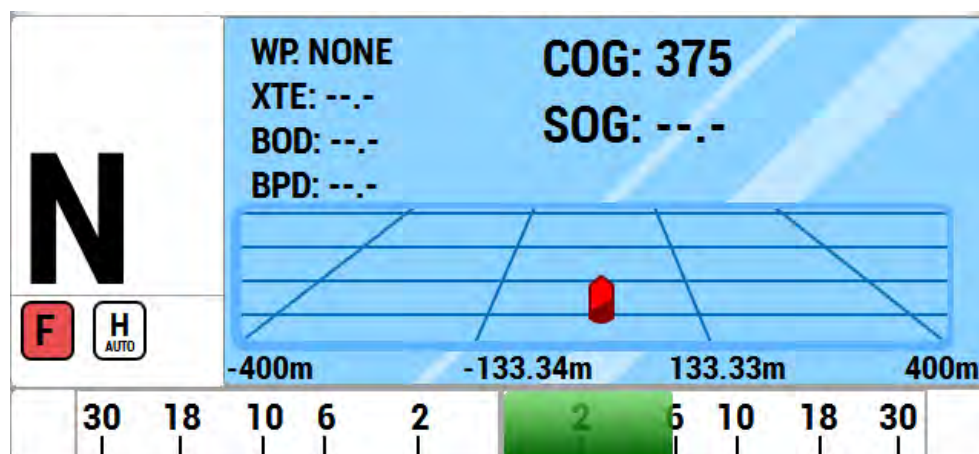

Figure 53 – Typical NAV Mode Screen (Alternate Display)

To change back to the normal display, press the NAV button again.

In the alternate NAV display, cross-track error is shown graphically by the boat icon being located to the left or right of the centerline. The position is proportional to the amount of cross-track error. Note the small numbers in the lower corners of the highway display. These indicate the scale of the display. There are four scales that can be shown on the highway display: 0.2, 0.5, 1.5, and 3.0 nautical miles. The scale changes automatically to give the best resolution.

Dodge

When in AUTO, NAV, WORK or modes, you can use the PORT and/or STARBOARD ARROW buttons to avoid (“dodge around”) an obstacle in the water.

Pressing and maintaining either the PORT ARROW button or STARBOARD ARROW button will cause the P4 to turn the vessel in that direction.

As long as one of the buttons is pressed, the rudder will keep moving in the corresponding direction.

- If one or both of the Power Steer Rudder Limits and/or the Auto/NAV Limits are set, then the autopilot will stop moving the rudder when it gets to the lesser of the limits.
- If neither of the Rudder Limits are set, then the autopilot will stop moving the rudder when it gets within a few degrees of the physical limits of rudder travel.

Once the button is released, the Autopilot will turn the vessel back to the commanded course (i.e., Heading, Track, or Angle, depending on which operating mode is in effect).

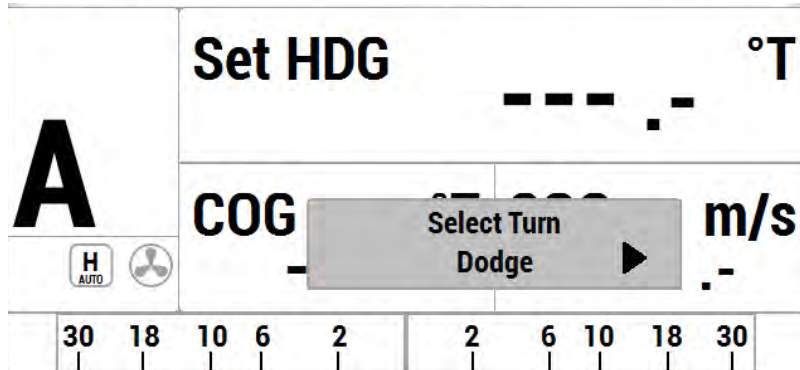

Figure 54 – A Dodge in Progress (in AUTO Mode)

Caution! During a Dodge turn (for example, while one of the ARROW buttons is maintained), the Autopilot will not limit the rate of turn of the vessel. Once an ARROW button is released, the autopilot will begin to turn the vessel back to the Commanded Course, but this time the turn will occur at no greater than the maximum turn rate that is set in the Steering Parameters.

NOTE: If you dodge the vessel in AUTO or WORK modes, when you release the PORT or STARBOARD ARROW button, the vessel will return to the same Heading, but not the same Track. The new Track will be offset from the original Track by the distance traveled during the Dodge manoeuvre. This is illustrated in Figure 55.

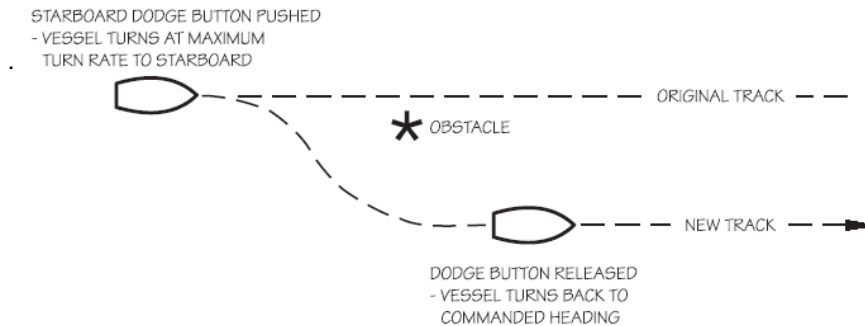

Figure 55 – Vessel Track During a Dodge Manoeuvre in AUTO Mode

By contrast, when you execute a Dodge in NAV mode, the autopilot will return the vessel to the original Track, once you release the PORT and/or STARBOARD button.

If desired, you can also bring the rudder back to centre (Dead Ahead) part-way through a Dodge. For example, you might want to center the rudder in order to maintain a temporary but specific Heading that the vessel has reached during the dodge.

- Press the other ARROW button (PORT if you are dodging to Starboard, and vice-versa), without releasing the button already being pressed.
- Maintain both the ARROW buttons simultaneously for as long as you wish to keep the rudder centred.

The course that the vessel follows while both buttons are pressed will typically be a straight Track, at approximately the Heading that was current at the time the second button was pressed.

However, this can be affected by weather and waves, by the vessel's rudder speed and steering response time, and any directional offset that the vessel exhibits when the rudder is centred.

- Releasing one button will re-start a Dodge in the other direction.
- Releasing both buttons will end the dodge completely, with the same mode-dependant behaviour with respect to "Resuming the Track" as noted previously.

Jog Lever Turns

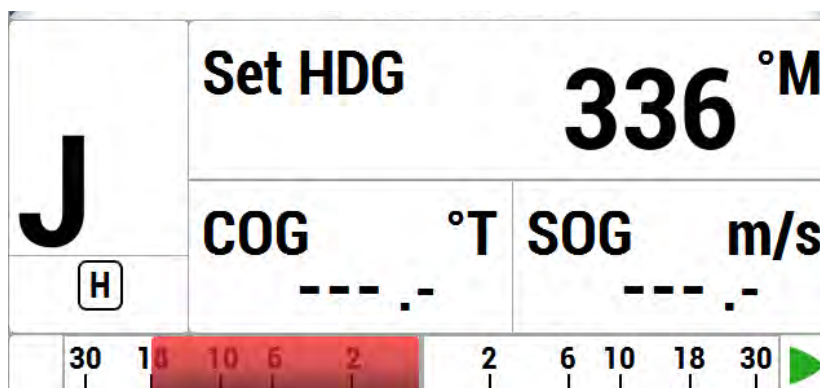

Figure 56 – Typical Jog Lever Activated Screen

If a Jog Lever is connected to SPU terminal block **J3**, you can directly change the vessel's heading with that Lever, while the P4 is in POWER STEER, AUTO, NAV, or WORK modes. This is identical to a Dodge, except that you use a Jog Lever to start and control it, and also you can do it while in POWER STEER mode.

When a Jog Lever is activated, the rudder will move immediately in the requested direction, to Port or Starboard (the autopilot system allows connecting any desired number of Jog Levers).

As long as the Jog Lever is held activated, the rudder will keep moving in the corresponding direction.

- If one or both of the Power Steer Rudder Limits and/or the Auto/NAV Limits are set, then the autopilot will stop moving the rudder when it gets to the smaller of the limits.
- If neither of the Rudder Limits are set, then the autopilot will stop moving the rudder when it gets within a few degrees of the physical limits of rudder travel.

When you release the Jog Lever, the autopilot will return the vessel to the current commanded Heading if in AUTO or WORK modes, or to the current track to the next waypoint if in NAV mode.

Whenever a Jog Lever is activated, a large “J” is displayed in the upper left corner of the Control Head’s screen (see [Figure 56](#)) – temporarily replacing the current mode’s indicator letter.

The jog Levers are ignored when the autopilot is in STANDBY mode, or in DOCKSIDE SETUP mode.

Caution! *You should always be prepared for a change in the vessel’s direction when you release the Jog Lever.*

Advanced Operations

Advanced Operations

This chapter describes the advanced modes of operation and features of a P-Series system, and shows you how to use them.

WORK Mode

WORK mode is a special mode, for use in conditions that are different than normal autopilot operation. Some prime examples are dragging, trawling, and pair trawling. It is also useful for towing or when traveling at very slow speeds. WORK mode can be activated in either AUTO or NAV mode. You can even switch from AUTO to NAV mode or vice-versa, while WORK mode is active.

Initial set up of WORK mode is easily accomplished. Only two parameters need to be adjusted: a Work Trip Point and the Rudder Scaling Factor. Some other parameters can be used to monitor and fine-tune the operation of WORK mode.

The autopilot has an automatic Off-Course Alarm that will be activated should the boat fall off the Commanded Heading by more than 20°. There is a 30 second delay on this alarm.

Automatic WORK Mode

Although WORK mode can be used manually, it works best if a valid NMEA source for the boat's speed is also interfaced to the autopilot. The speed source must also be properly configured (in the Auto menu, see page 127). With a valid NMEA speed source, WORK mode can be engaged automatically when the boat's speed falls below the Work Trip Point, and disengaged when the boat's speed increases beyond the Work Trip Point.

To use Automatic WORK mode, first go into either AUTO or NAV mode. Then press and hold the WORK button for approximately 1 second, until a confirming beep is heard. A small letter 'W' will appear beside the bigger mode-indicator letter ('A' or 'N') in the upper left portion of the LCD screen, to indicate that the WORK mode feature is enabled.

If the boat's speed is above the Work Trip Point, the 'W' will flash slowly, about once per second, indicating that WORK mode is enabled – but not yet engaged. If the 'W' appears continuously (not flashing), the boat speed is below the Work Trip Point, and WORK mode is actually engaged.

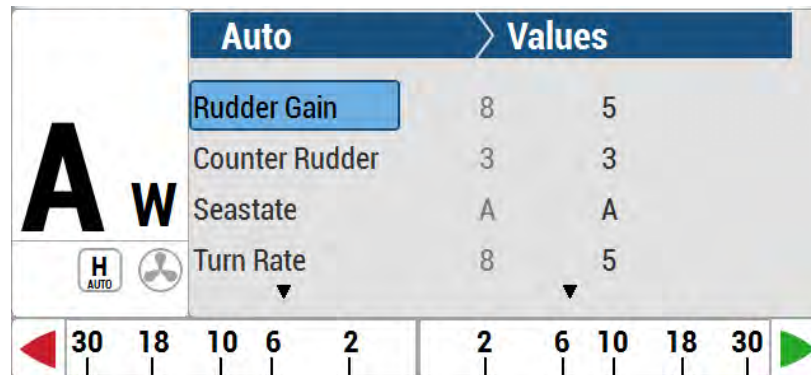

Figure 57 – Typical WORK Mode Screen (Engaged)

To disable WORK mode, press the WORK button again, for approximately 1 second, until a confirming beep is heard and the letter 'W' disappears from the display. WORK mode can also be cancelled by switching to either STANDBY or POWER STEER mode.

When WORK mode is engaged, the Rudder Scale Factor changes the amount of corrective rudder movement which the steering algorithms calculate using the Rudder Gain setting. In WORK mode, that calculated amount (i.e., proportional to the course error) will also be multiplied by the Scale Factor, resulting in larger rudder movements for a given course error. The Rudder Scale Factor is entered on the Work menu.

Other effects take place in WORK mode too.

- The corrective rudder movement calculated for Counter Rudder is reduced to the minimum possible for the vessel type (i.e., as if the Counter Rudder parameter was set to 0), which enhances the effect of the Rudder Gain and Rudder Scale Factor.
- Turn Rate is limited to 10° per second while WORK is active, for all changes of Heading controlled by the autopilot, and for Special Turns.
- Particularly useful for pair trawling, the autopilot also disables the automatic course trim unless Autotrim (in the Work menu) is specifically turned on.
- Finally, the built-in off-course alarm will be disabled the entire time WORK mode is engaged.

If the user is not satisfied with the fixed helm bias determined by the Autopilot at the onset of WORK mode, manual adjustments can be made “on-the-fly” while WORK mode is engaged. A double-press of the WORK button will bring up the regular Work menu, but with an additional line.

Rudder Bias will be the first line on the list, and will show the current helm bias. You can change this value to suit, using the COURSE CHANGE knob. This feature is useful in order to accommodate changing load or sea conditions.

As mentioned earlier, WORK mode will automatically be disengaged if the boat's speed rises above the Work Trip Point set by the user. While it is disengaged, all normal features such as automatic trim and off-course alarm will be operational.

Manual WORK Mode

Even if no NMEA source of speed data is available, WORK mode can still be used, by manually initiating it.

To do so, switch to AUTO or NAV mode, and then press the WORK button for ~1 second until the letter `A` or `N` in the upper left portion of the display stops flashing, and a small letter `W` appears beside it.

Then, double-press the WORK button to bring up the Work menu. Highlight "Work Mode State". Then use the COURSE CHANGE knob to change the selection to "**M_On**" (Manual On). WORK mode is now engaged.

***Caution!** When Manual WORK mode is engaged, large rudder movements may occur. If your boat is traveling too fast, these rudder movements may affect the stability of the boat. Do not engage Manual WORK mode without first ensuring that it is safe to do so and that the boat speed is appropriate for using WORK mode.*

To disengage WORK mode, again select "Work Mode State" in the Work menu and change it to "**A_Rdy**" (Automatic Ready).

To cancel WORK mode completely, press and hold the WORK button for 1 second, or switch to STANDBY or POWER STEER mode.

You can also manually disengage WORK mode, if it has been engaged in the automatic mode. Double-press the WORK button to bring up the Work menu. If WORK mode is engaged, the "Work Mode State" will show "**A_On**" beside it. Highlight "Work Mode State", then use the COURSE CHANGE knob to change it to "**M_Rdy**" (Manual Ready).

Work Menu

The Work menu has all of the adjustable parameters that are involved with WORK mode. To access the Work menu, double-press the WORK button.

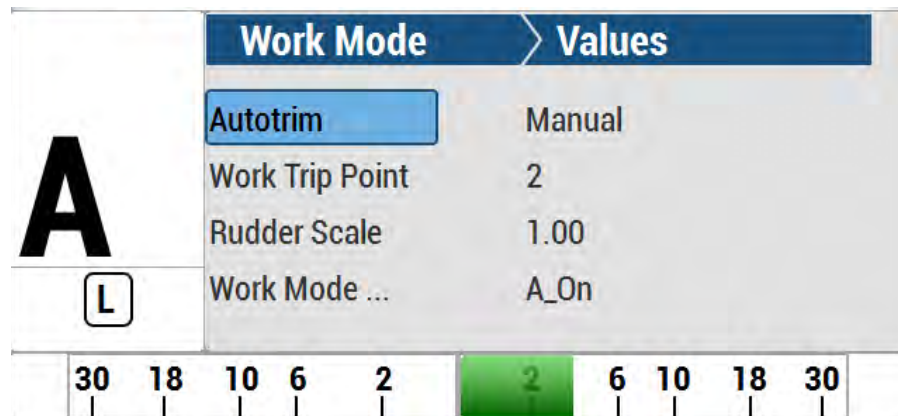
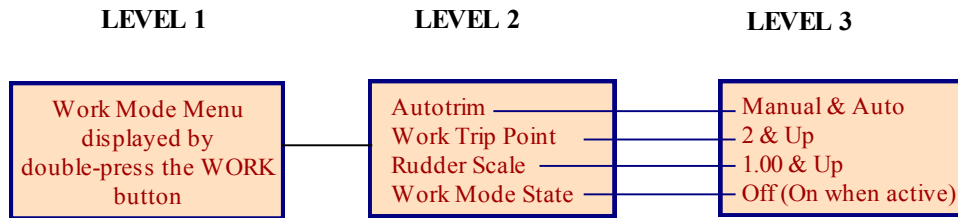

Figure 58 – WORK Mode Menu

Rudder Bias

This menu line only appears when WORK mode is active. It shows the current rudder bias, which can be adjusted if desired.

Autotrim

The autopilot's WORK mode can be configured to use manual or automatic rudder bias trim when in WORK mode (the default is to use automatic bias).

Manual rudder bias is fixed by the position of the rudder when the autopilot first enters WORK mode, but can be adjusted by the user if desired.

Automatic rudder bias is initially set to the position of the rudder when the autopilot first enters WORK mode, but is automatically adjusted on a continual basis thereafter to ensure that the vessel remains on-course.

Work Trip Pt. - Work Trip Point

This is the speed below which WORK mode can be engaged, and above which WORK mode will be disengaged automatically. The value can be 1 to 10, and these units refer to the information the Speed Source (see the **Auto** menu) is providing.

Rudder Scale - Rudder Scale Factor

When WORK mode is engaged, the “Rudder Scale Factor” will multiply the Rudder Gain setting in the Auto menu. Normally, the rudder is moved an amount proportional to the course error detected (for example, the error times the Rudder Gain, and using some constants which depend on vessel type), but in WORK mode that amount will also be multiplied by the Scale Factor. This will always result in larger rudder movements for a given course error.

Work Mode State

This parameter shows the current status of WORK mode. It is also a means to force WORK mode to be active or not. Normally, WORK mode is engaged or disengaged depending on the speed of the boat as given by a Navigation System. In cases where this information is not available, WORK mode can still be made to function by forcing it on.

The states shown are “Off”, “A_On” and “A_Rdy” (abbreviations for Automatic On and Automatic Ready, respectively), or “M_On” and “M_Rdy” (Manual On and Manual Ready).

Special Turn and Turn Menu

Pre-define Special Turns

There are a number of Special Turns pre-programmed into the P4 system. Special Turns can be executed only in AUTO and NAV modes.

To execute a Special Turn (with the autopilot in the appropriate mode):

- 1) Press the TURN button. The default special turn will be displayed, along with a query for a direction.
- 2) If a different special turn other than the default shown is desired, press the TURN button again. The next special turn in the available list will be shown. Press the TURN button again and again until the desired special turn is shown.
- 3) Press either the PORT or STARBOARD ARROW button to select the direction in which to execute the Special Turn.



Figure 59 – Typical Special Turn Query

The default Special Turn can be changed as desired by adjusting the “Default Turn” in the TURN menu.

Special Turns can be aborted by pressing the TURN button again while the Special Turn is executing, or by changing modes.

U-Turn

For a U-Turn, the autopilot calculates a reciprocal course to the vessel's heading, and then turns the vessel to that heading, in the appropriate direction, once the PORT or STARBOARD ARROW button is pressed.



Figure 60 – U-Turn Query

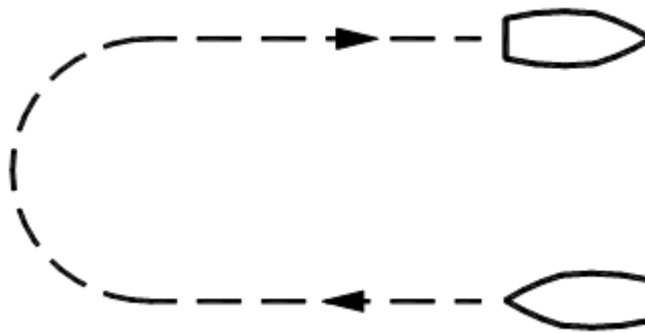

Figure 61 – U-Turn Vessel Path

Circle Turn

For a circle turn, the autopilot steers a never-ending circle in the appropriate direction once the PORT or STARBOARD ARROW button is pressed. The Turn Rate setting in the Auto menu governs the rate of turn. To stop the circle, press the TURN button again, or switch modes.



Figure 62 – Circle Turn Query

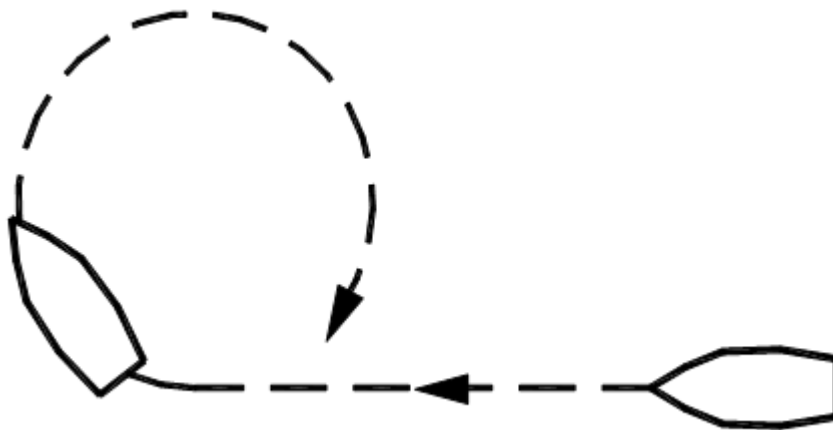

Figure 63 – Circle Turn Vessel Path

M.O.B. – Man Over-Board

The autopilot can perform a Williamson / Man Overboard turn, sometimes known as an Emergency or E-turn. This will bring the vessel onto a reciprocal heading; typically, right down the vessel's own wake. The PORT or STARBOARD ARROW buttons are used to determine the initial turning direction. For best accuracy, do not adjust the vessel speed once this turn has been initiated.



Figure 64 – Man Overboard (MOB) Turn Query

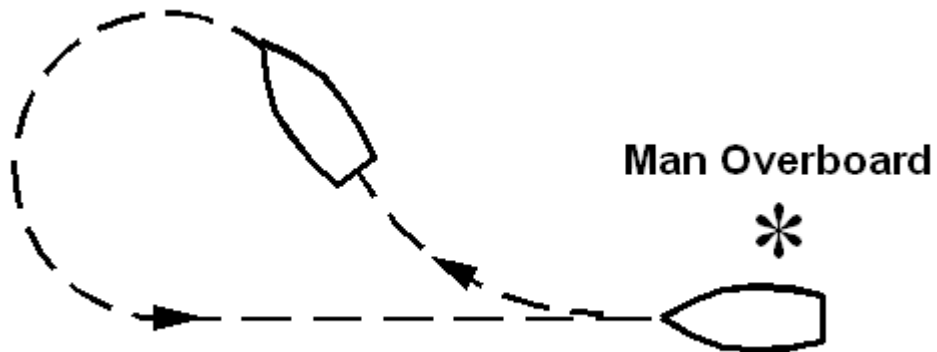

Figure 65 – Man Overboard (MOB) Turn Vessel Path

Pre-Tack Turn

For a Pre-Tack turn, the autopilot makes a course change in the degrees set by the Pretack Angle. Pre-Tack Angle is set in Turn Menu.

Fishzag

As its name implies, the Fishzag turn was developed specifically for fishing.

When this Special Turn is executed, the autopilot maintains the present course for the time interval specified by the Fishzag Timer in the Standby menu. Once the timer has expired, the autopilot will make a 60° course change in the direction specified when you pressed the PORT or STARBOARD ARROW button.

After 30 seconds, the autopilot will return to the original course, and start the timer over again. This time, when the timer goes off, the autopilot will make a 60° course change in the opposite direction. Again, after 30 seconds, the autopilot will return to the original course where the cycle repeats itself.

The Fishzag turn has the effect of dropping the fishing gear behind one side of the boat, and raising the gear slightly on the other side while the boat is turning. This has been shown to be an effective means of luring fish to strike.

To cancel the Fishzag turn, press the TURN button again, or switch modes.



Figure 66 – Fishzag Turn Query

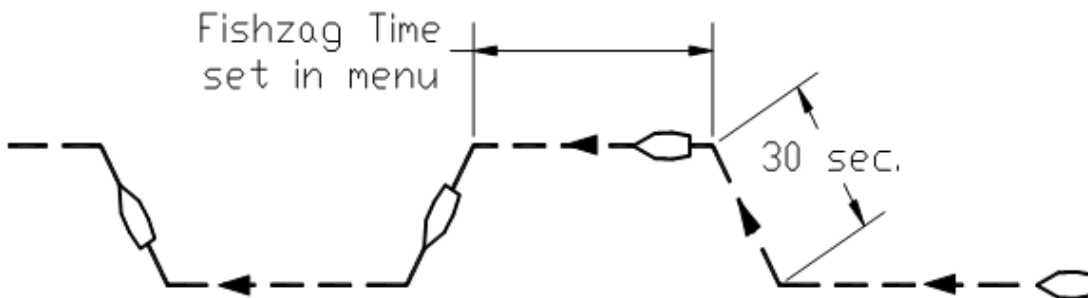
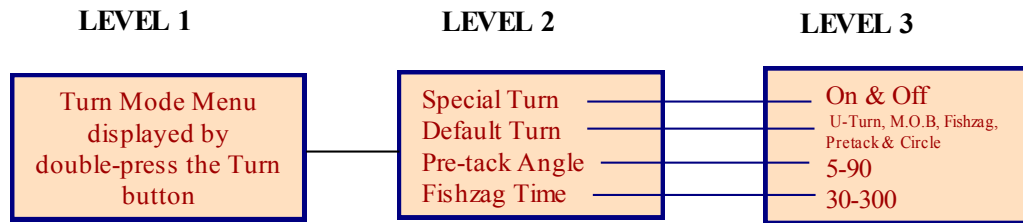

Figure 67 – Fishzag Turn

Turn Menu

The TURN menu has all of the adjustable parameters that are involved with TURN mode. To access the TURN menu, double-press the TURN button.



Turn screen:

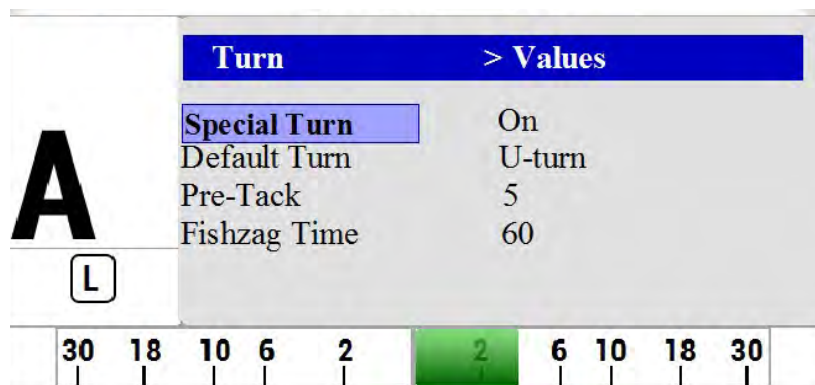

Figure 68 - Turn Menu Screen

Special Turn

Select Off to disable the TURN button. No Turn described in this menu is allowed when Special Turn is Off.

Default Turn

Select different Turn such as U-Turn, Circle-Turn, M.O.B, Pretack & Fishzag

Pre-Tack Angle

Pre-Tack Angle allows users to set the degrees of course change to make during the Pre-Tack turn. This angle can be set to 5, 10, 15, 20 or 90 degrees.

Fishzag Time

The unit for this value is in Second. Users can select from 30 to 300 seconds in the step of 30 seconds.

Station Lock/Unlock

Setting the Station Lock parameter in the Standby menu to Lock prevents any of the Repeaters from being able to take command. When station lock is set to Lock, the image of a key will be shown in the upper right corner of the display, next to the repeater R.

The key image will either be outlined or filled-in, depending on whether the station lock is for the main Control Head or an Auxiliary.

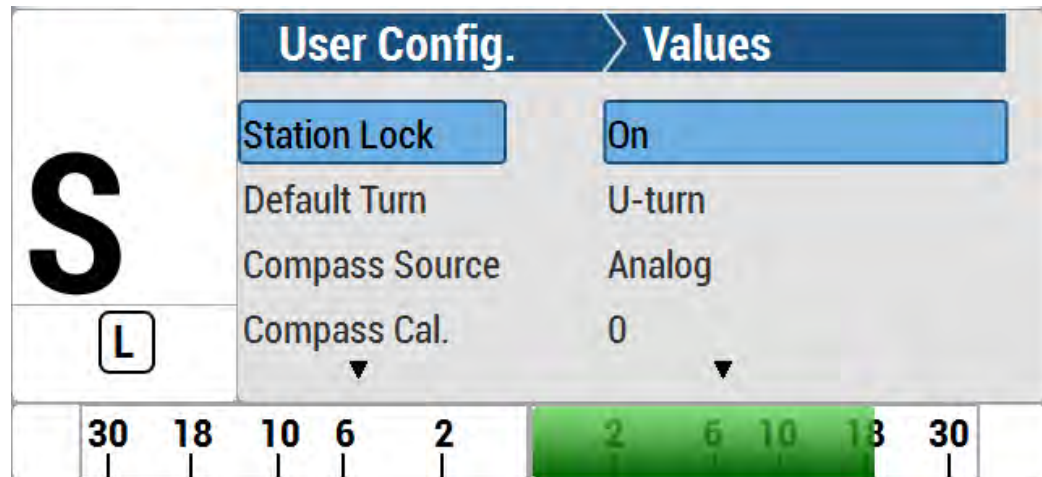

Figure 69 – Station Lock Icons on the screen

The controller In-command shows a locked locker icon. The Locker signifies that all stations, except for the Master Control Head and the controller which is currently In-command, are locked out.

Controllers that are Repeaters cannot take command.

Caution! *If your P4 system is equipped with Jog Levers, you must be aware that they can be activated any time the autopilot is turned on. They can not be turned off or locked out. It is your responsibility to see that appropriate measures are taken to ensure that they cannot be activated by accident.*

Care and Maintenance

Care and Maintenance

The P4 Advanced Autopilot System has been designed to provide many years of reliable service. The following periodic care and maintenance tips will help to ensure the longevity of your autopilot.

Cleaning and Appearance

Both the Control Head and SPU should be regularly and carefully cleaned with a damp cloth and mild soap. This is particularly important for the LCD screen overlay.

Caution! Do not use abrasive cleaners or chemicals.

The Control Head is designed to be weatherproof and splash resistant, but it should not be immersed in water for a prolonged period of time.

Environments exceeding a maximum temperature of 140° F (60° C) or below a minimum temperature of 5° F (-15° C) MUST BE AVOIDED.

Exposure to prolonged direct sunlight should be avoided in order to prevent damage to the electronics and housing, and UV-induced fading of the LCD.

Protection of Wires and Cabling

After installation, ensure that the system components are securely mounted and will not shake loose due to the vibrations that can be expected in a marine vessel.

Ensure that the cabling and wiring to all system components, ESPECIALLY REMOTE CONTROLS, are well secured with clamps or alternative fasteners.

Many potential problems can be avoided by ensuring that cabling and wiring do not cause strain on the connectors.

Periodic Checks

After the first six months of operation a thorough examination of the entire Autopilot system must be undertaken. All electrical connections, cables, clamps, mounting brackets, and mechanical connections (i.e. RUDDER FOLLOWER) must be secure. All hydraulic pumps and lines must be inspected for leakage and loose mounting.

An annual inspection should be undertaken thereafter.

Fuse Replacement

There are two fuses used on the SPU.

Replace fuses only with the same type and rating, as per the table below.

Should a fuse blow, determine the cause before replacing.

To inspect and/or replace a fuse, the clear plastic cover over the SPU's Diagnostic section must be removed. To do so, gently pry up the center portion of the plastic rivets which fasten the cover to the SPU's case; be careful not to lose any of the plastic pieces.

After the fuse(s) are replaced, the cover must be re-installed, and remain in place during normal operation.

Designator	ComNav Part Number	Generic Description <i>Manufacturer(s) and Part Number(s)</i>
F1	60810009	20A, Non-Time Delay, 125V, ¼"x 1-1/4" Bussman ABC -20
F2	60810012	<i>3.15A Medium Time Delay, 125V or better, 5 x20mm (DIN41571, IEC127, Bussman GMC 3.15A</i>

Table 7 – Fuse Replacement Guide

Appendices

Appendix 1

NON- NMEA 2000 Heading Sources

The following is how to install and connect a ComNav Magnetic/Fluxgate Compass and Rotary Feedback Follower.

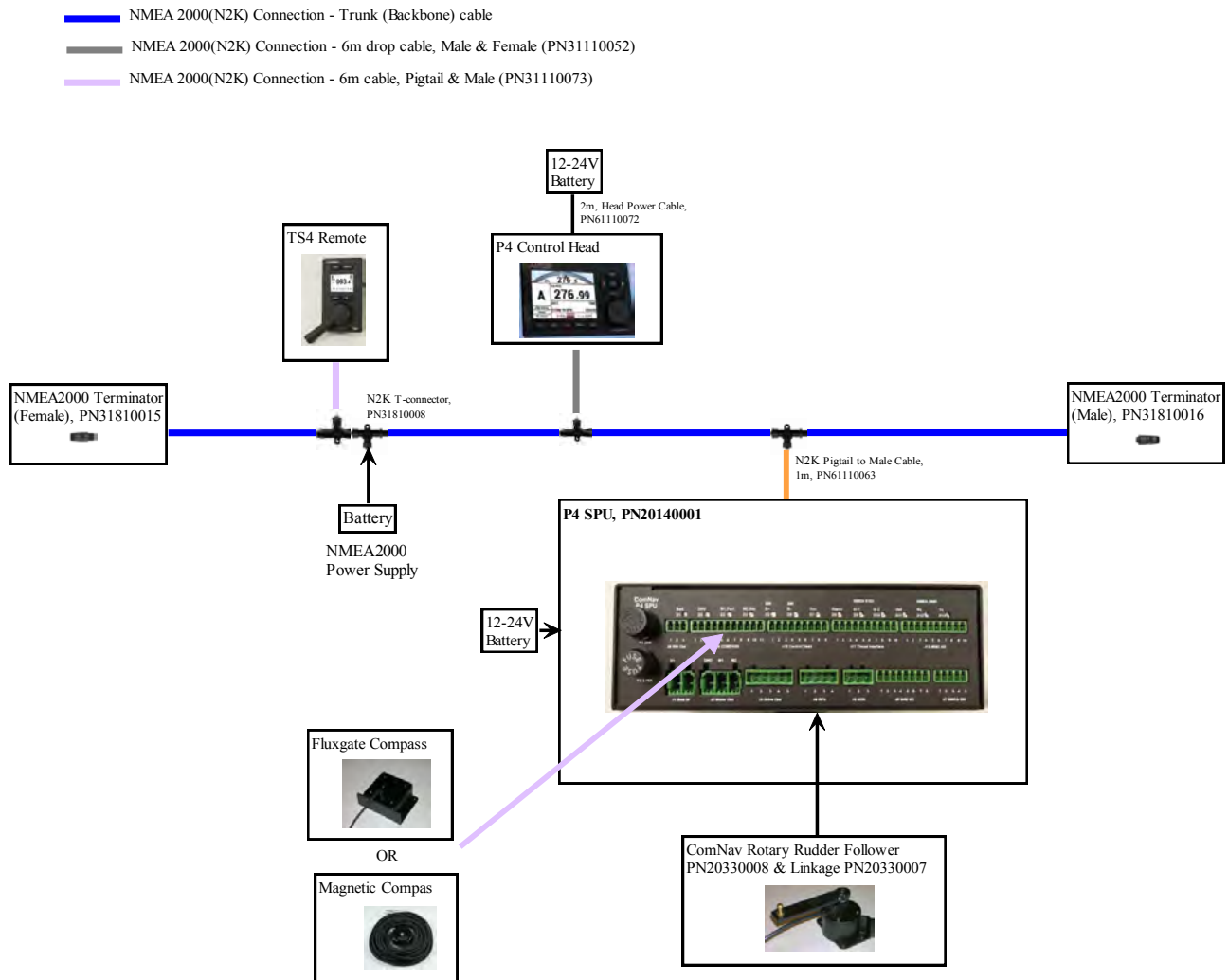

Figure 70 - NMEA 0183 / NMEA 2000 System

Appendix 2

NON-NMEA2000 ComNav Product Support

NMEA0183 Compass (GNSS G1/G2/G2B):

PN 11220001 or 11220002 (G2) – NMEA0183 model with 15 or 30 metre cable

PN 11220003 or 11220004 (G2B) – NMEA0183 model with 15 or 30 metre cable

The ComNav GPS Compasses are state-of-the-art devices which can provide accurate 2D Heading and Position data to autopilots, sonar, chart-plotters, AIS transponders.



Figure 71 – GNSS G2 GPS Compass

The P4 has the ability to accept Navigation Data and information formatted in NMEA 0183 standard (version 3.00).

Many marine electronics devices (such as digital compasses, GPS receivers, chart-plotters, and electronic charting systems, to name a few) have outputs complying with NMEA 0183.

Two such devices can be connected directly to the P4's SPU, by wiring them into the plug mated to the receptacle labelled **J6 – NAV I/O**. The signals are utilized by configuring NAV1 & NAV2 through DOCKSIDE Setup (select "NMEA" under Compass in DOCKSIDE Setup). The SPU also has an NMEA0183 output; it transmits the autopilot's real-time Heading Data and status information, for use by devices such as a radar display, a chart plotter or a navigation program on a PC.

Refer to [Appendix 1](#) for more information on the NMEA 0183 sentences accepted and sent by the system.

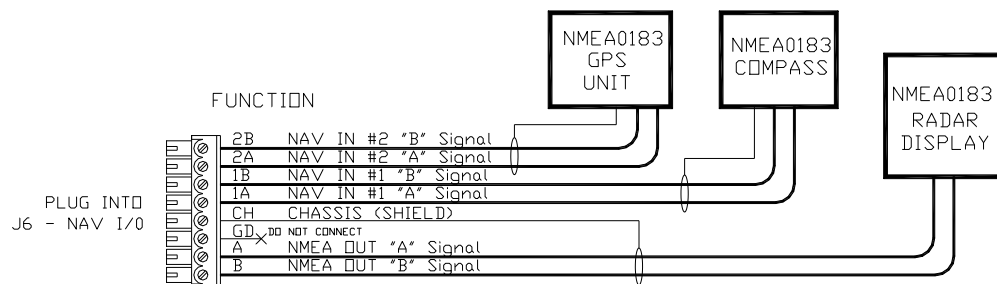

Figure 72 – Typical NMEA 0183 Connections

For standard installation, Port 1 of GNSS compass is set for GPS (SOG, COG) signals and Port 2 of GNSS compass is set to compass signals (HDT) signal.

For proper operation, the connected device(s) must fully comply with NMEA 0183 Standard (version 3.00):

- RS-422 electrical levels
- Baud rate: 4800
- Serial data format: 8 data bits, no parity, 1 stop bit
- Correct NMEA sentence structure
- Checksums are optional, but must be valid if present

It may also be possible to use RS-232 electrical levels, in some cases, such as when using a PC.

NOTE: The **NAV2** port can optionally be run at 9600 Baud. To do so, you simply need to set the other device to transmit at that rate. The SPU automatically sets the rate for this port, by looking for “valid NMEA data” at all possible Baud rates.

NMEA0183 SSRC gyrocompass:

Check the manual. The wiring diagram is to SPU J6 –NAV I/O & J12 MISC I/O as below. Setup is, in DOCKSIDE setup, select SSRC under Compass.

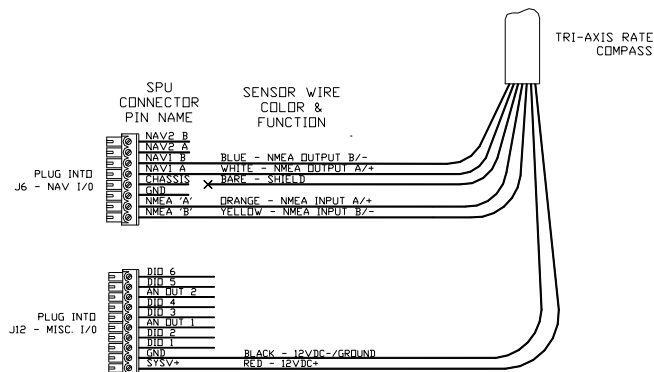

Analog Compass (Fluxgate & Magnetic Compass):

Fluxgate Compass

PN 20320008

Specifically designed for ComNav autopilots, the ComNav Fluxgate Compass directly senses the Earth’s magnetic field. The unit incorporates a heeling coil for better performance when the vessel is either rolling or heeled. The Fluxgate Compass is a sealed, waterproof unit which may be mounted on a deck, shelf, or bulkhead. This compass outputs the traditional analog Sine and Cosine compass signals. It is supplied with a 12 metre (40’ cable with flying leads to wire it into the P4’s SPU.



Figure 73 – Fluxgate Compass

Compass Wiring

All compasses, other than NMEA 0183 compasses, are connected to the SPU receptacle labelled **J9 – COMPASS** (see the **Compass** section for how to connect NMEA compasses).

If you ordered your P4 system with a ComNav Fluxgate Compass, the cable wires connect to the **J9** receptacle, as per the diagram in **Figure 74**.

If you ordered your system with the Magnetic Sensor, and mounted it on the bottom of your magnetic compass, you will also need to wire the flying-lead end of the sensor cable as per the diagram in **Figure 74**. If you mounted the sensor on top of the compass, simply exchange the blue and yellow wires.

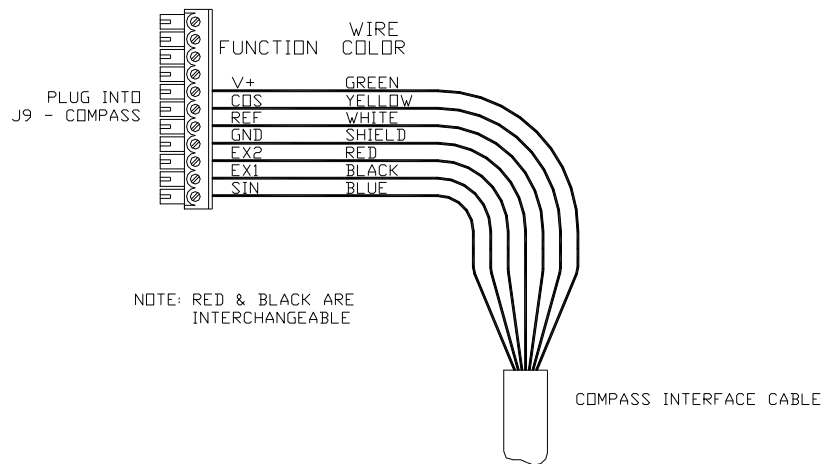
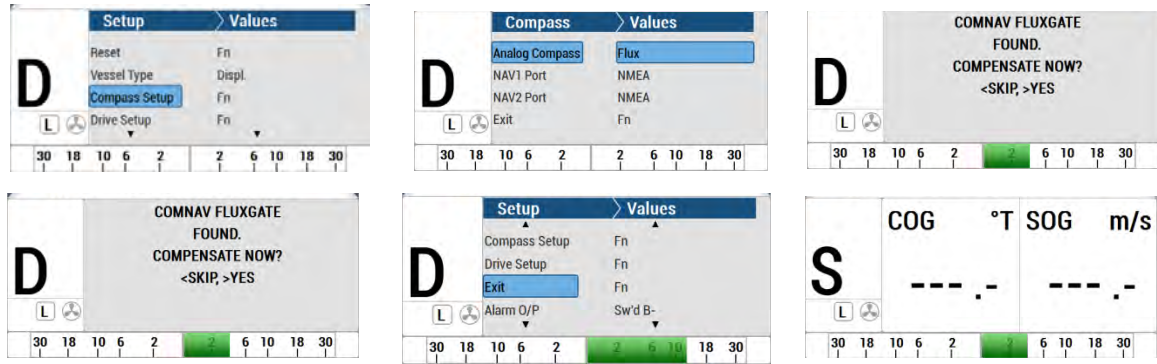

Figure 74 – Wiring Connections for Analog Compasses



To configure a Fluxgate compass:

1. Enter SPU DOCKSIDE Menu: power-down & up the system, press LEFT & RIGHT ARROW KEYS <> at the same time when the instruction is on the screen.
2. Note that the “D”(Dockside Setup Menu) on the left side of the screen
3. For first time compass set-up, it is not important to have a valid compass reading (it may be from N2K network (Compass Reading HDG XXX is a N2K compass)
4. Note that “D” (Dockside Setup Menu) on the left side of the screen
5. Select Compass Setup
6. Select Analog Compass from none to Flux
7. It will display “ComNav Fluxgate found”
8. After Dockside, the screen returns to “Compass”
9. Select “Exit” on the Dockside Setup Menu, DO NOT use the MENU button to go to the previous screen.
10. Check that “S” on the left side of the screen showing STANDBY mode
11. From the STANDBY mode screen, the compass reading will now show “**CPS XXX.X°M**” where XXX.X is the Fluxgate compass reading.

Magnetic Compass Sensor

PN 20320002

The ComNav Magnetic Compass Sensor ([Figure 75 on the right](#)) detects the position of the compass card of an externally gimballed magnetic compass ([Figure 75 on the left](#)). The sealed unit can be attached to the bottom of any of ComNav’s Magnetic Compasses, or the bottom or top of many other brands of externally gimballed magnetic compasses. It is wired directly to the SPU, with the attached 25’ cable.



Figure 75 – Externally Gimballed Magnetic Compass with Magnetic sensor

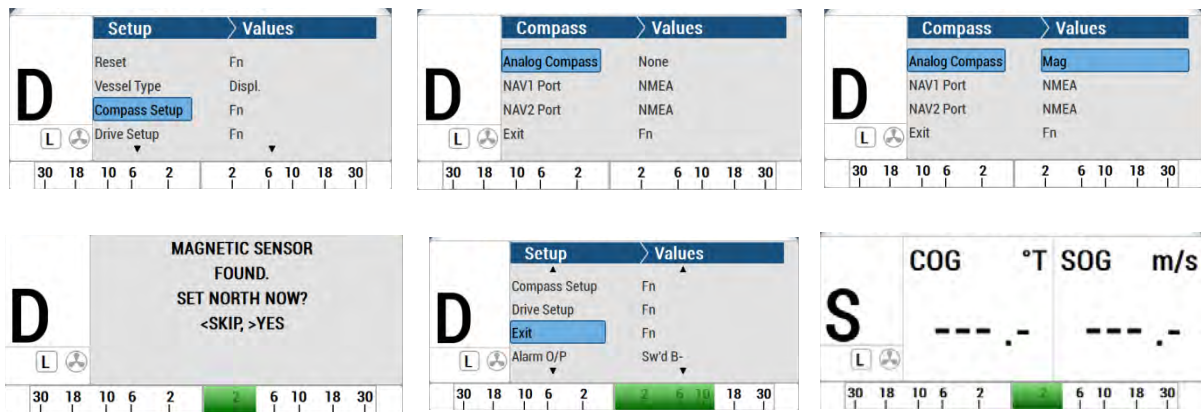

To configure a Magnetic compass:

1. Enter SPU DOCKSIDE Menu: power-down & up the system, press LEFT & RIGHT ARROW KEYS <> at the same time when the instruction is on the screen.
2. Note that the "D"(Dockside Setup Menu) on the left side of the screen
3. For first time compass set up, it is not important to have a valid compass reading it may be from N2K network (Compass Reading HDG XXX is a N2K compass)
4. Note that "D" (Dockside Setup Menu) on the left side of the screen
5. Select Compass Setup
6. Select Analog Compass from none to Mag
7. It will display "Magnetic sensor found"
8. After Dockside, the screen returns to "Compass"
9. Select "Exit" on the Dockside Setup Menu, DO NOT use the MENU button to go to the previous screen.
10. Check that "S" on the left side of the screen showing STANDBY mode
11. From the STANDBY mode screen, the compass reading will now show "CPS XXX.X°M" where XXX.X is the Magnetic compass reading.

P-Series Remote (Remote CR203 & TS203):**CR-203 Remote****PN 20310026 – 12m (40') cable****PN 20310028 – 18m (60') cable**

The CR-203 Handheld Remote is specifically designed to operate with the Commander P2 Advanced Autopilot System. The CR-203 Remote provides selection of **STANDBY**, **TILLER**, **AUTO**, and **NAV** mode. In **TILLER** mode, the vessel's rudder position is tied to the position of the CR-203's Tiller knob. In **STANDBY**, **AUTO** & **NAV** modes, the CR-203 operates identically to the Commander P2's Control Head. The CR-203 Remote supports **WORK** mode (Refer to **WORK Mode** in the **Advanced Operations** section for an explanation of that mode).

**Figure 76 – CR-203 Handheld Remote**

TS-203 Remote
PN 20310025

The TS-203 Fixed Remote is a heavy duty Full-Follow-Up (FFU) Lever control which allows the operator to control the tiller steering and autopilot functions from any work station, flying bridge or remote location on the vessel.



Figure 77 – TS-203 Fixed Remote

If you have P-Series Remote such as CR203 or TS203, wire them into the plug mated to the receptacle labelled **J10 – Control Head** as the following diagram.

Control Head Connection

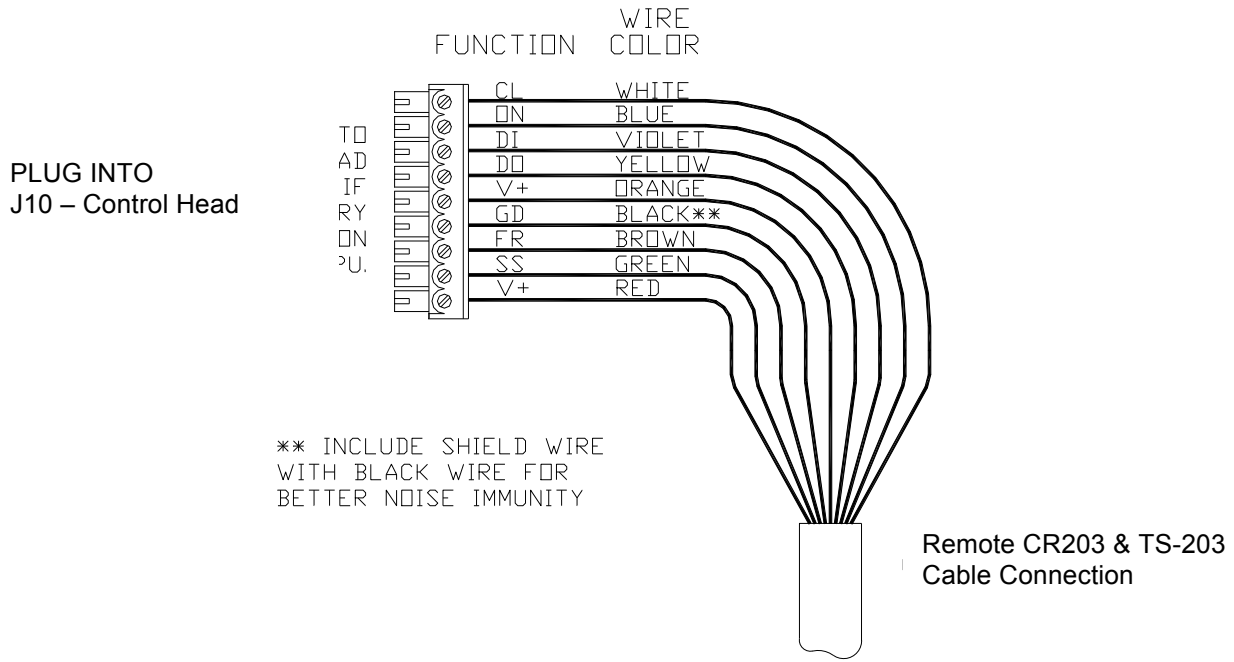

Figure 78 - Wiring Connections for Control Head, Handheld Remotes, and Fixed Remotes.

Other Controls, Indicators and Sensors

Jog Levers

PN 20310002 (1 set of switches)

PN 20310003 (2 sets of switches)

ComNav's Non-Follow-Up (NFU) Jog Lever is a permanently mounted, watertight, electrical switch specifically designed for marine use. The spring-centered lever is moved port or starboard as desired to provide non-follow-up (time dependent) electrical control of the vessel's steering system.



Figure 79 – Jog Lever

Jog Levers

Any number of Non-Follow-Up (NFU) Jog Levers can be connected to the P4 SPU. They are simply wired in parallel to each other. Connect them to the terminal labelled **J5 - JOG LEVER** as per the following diagram in **Figure 80**:

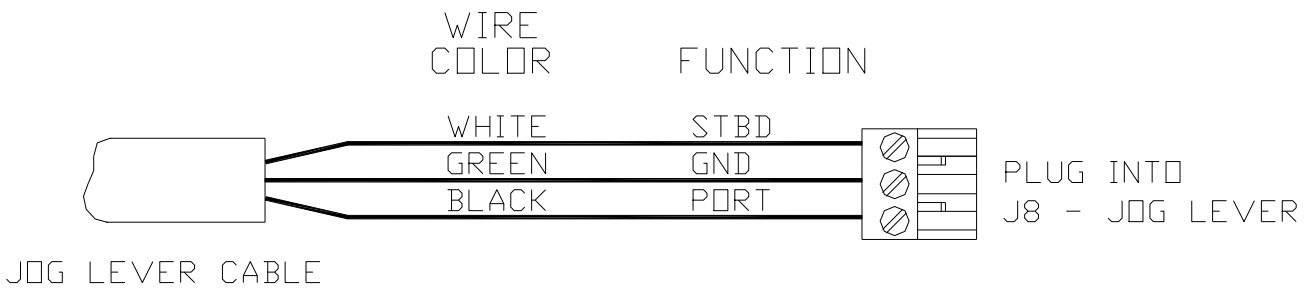

Figure 80 – Wiring Connections for Jog Levers

In order to use the Jog Levers connected in the above manner, the autopilot must be turned on. The autopilot will then move the rudder either port or starboard for as long as the Jog Lever is held activated. However, the autopilot will stop the rudder when it gets to the (user-adjustable) rudder limits programmed into the autopilot. This reduces stress on the steering system.

Rudder Angle Indicator (RAI) – 3"

PN 20360014

The ComNav RAI is a backlit 3" (76 mm) diameter gauge that displays the actual position of the vessel's rudder. The RAI is flush mounted, encased in high impact resistant polycarbonate plastic with a water resistant front face, and requires a lighting voltage supply of 12, 24 or 32 VDC.

An optional Bezel Kit (Part # 30360004), Wheelhouse Case (PN 20360017) and Watertight Case (PN 20360016) are available.



Figure 81 – External Rudder Angle Indicator - 3" Model

Rudder Angle Indicators

The P4 system will drive up to five 500 microampere Rudder Angle Indicator (RAI meters, such as those supplied by ComNav (PN 20360014. Mounting instructions are included with each meter. Wire the meter to the plug for the SPU receptacle labelled **J8 – RAI OUTPUT**. If you have more than one RAI meter, they should all be wired in series, as shown in [Figure 83](#):

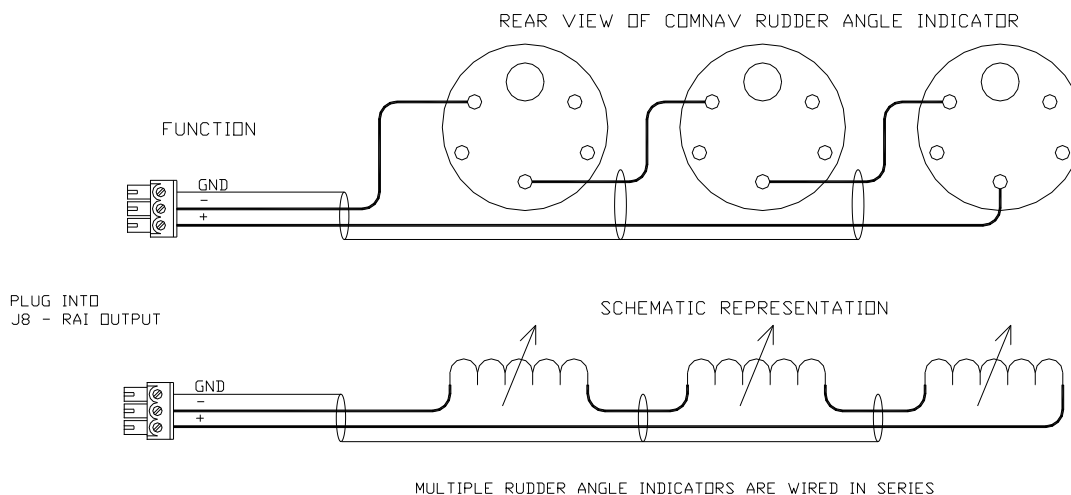

Figure 82 – Wiring Connections for Rudder Angle Indicators

Appendix 3

NMEA 2000 PGN numbers Accepted and Transmitted by the Autopilot

Transmitting standard PGNS

59392, 59904, 60928, 126996, 126464, 126208, 127250, 127245, 127237,
128259, 129025, 129026, 129283, 129284, 126993

Receiving standard PGNS

60928, 59904, 59392, 126208, 127250, 128259, 129025, 129026,
129029, 129283, 129284

NMEA 0183 Sentences Accepted and Transmitted by the Autopilot

The P4 Advanced Autopilot system receives and transmits serial data in NMEA 0183 format.

Messages Accepted

The P4 accepts the following NMEA 0183 sentences (the * in front of the sentences indicates that the TALKER Identifier is always ignored):

Sentence	Description	Data Used
*APA	Autopilot Sentence "A"	Cross-Track Error, Arrival Status, Bearing from Origin to Destination, Waypoint ID
*APB	Autopilot Sentence "B"	Cross-Track Error, Bearing from Origin to Destination, Waypoint ID, Course to Steer
*BOD	Bearing – Origin to Destination	Bearing from Origin to Destination, Waypoint ID
*BWC	Bearing and Distance to Waypoint	Range to Destination
*GLL	Geographic Position (Latitude and Longitude)	Latitude, Longitude
*HDG	Heading, Deviation and Variation	Magnetic Heading, Magnetic Variation
*HDM	Heading, Magnetic	Magnetic Heading
*HDT	Heading, True	True Heading
*HSC	Heading Steering Command	Course to Steer
*MWV	Speed and Angle	Angle, Speed
*RMA	Recommended Minimum Specific Loran-C Data	Speed
*RMB	Recommended Minimum Navigation Information	Cross-Track Error, Waypoint ID, Range to Destination, Bearing from Origin to Destination, Arrival Status
*RMC	Recommended Minimum Specific GNSS Data	Speed, Magnetic Variation
*VBW	Dual Ground / Water Speed	Speed
*VHW	Water Speed and Heading	Speed
*VTG	Course Over Ground and Speed	Speed
*XTE	Cross-Track Error	Cross-Track Error

Table 6 – NMEA 0183 Sentences Accepted by the P4

All sentences received must have valid checksums. Sentences which do not have any checksums, or have invalid checksums, will be ignored. In some cases, if the missing/invalid condition persists long enough, an INVALID CRS DATA, SPEED DATA, and/or HEADING error will occur.

A number of the various data values used by the autopilot can be received in one or more different sentences (for example, Speed can be received in VTG, VHW, VBW, RMA or RMC). If a particular data value is received in more than one sentence, then the value in the highest-priority sentence – per [Table 8](#) – will be the one used by the autopilot.

Data Used	Sentence	Sentence Priority <i>(larger number is higher priority)</i>
Magnetic heading	*HDM	1
True heading	*HDT	2
Magnetic heading, Magnetic variation	*HDG	3
Range to waypoint	*BWC	4
Vessel speed	*VTG	5
Vessel speed	*VHW	6
Vessel speed	*VBW	7
Bearing origin to destination magnetic and true, Waypoint ID	*BOD	8
Cross track error	*XTE	9
Cross track error, Arrival circle entered Bearing origin to destination magnetic or true, Waypoint ID	*APA	10
Course to steer magnetic and true	*HSC	11
Cross track error, Waypoint ID, Range, Bearing present to destination true, Arrival circle entered	*RMB	12
Cross track error, Arrival circle entered, Bearing origin to destination magnetic or true, Waypoint ID, Bearing present to destination magnetic or true, Course to steer magnetic or true	*APB	13
Vessel speed	*RMA	14
Vessel speed, Magnetic variation	*RMC	15
Latitude and longitude	*GLL	16

Table 7 - NMEA Sentence Priority

NOTE: The Heading value used by the P4 may be in Degrees Magnetic or True, depending on which sentences are received (assuming all sentences have valid data):

- *If all of HDM, HDT and HDG are being received, or just HDT and HDG, or just HDM and HDG, then the autopilot will use Magnetic Heading (indicated on the display by an 'M' beside the Heading value – and will use the data value in the HDG sentence.*
- *If only HDM and HDT are received, or just HDT, then the autopilot will use True Heading (indicated by a 'T'), from the HDT sentence.*
- *If only HDM is received, then the autopilot will use Magnetic Heading (indicated by an 'M'), from that sentence.*

Messages Transmitted

The P4 outputs NMEA 0183 compliant data (at 4800 Baud, on the OUT A/B pins of the **J9 – NAV I/O** connector), which may be used by NMEA 0183 compliant LISTENERS, or may be used to observe and/or record various P4 parameters, for diagnostic purposes, while the system is running.

The P4 outputs 3 sentences:

***HDG** Heading, Deviation and Variation

***HDT** Heading, True

***PCMNS** (ComNav Proprietary Sentence)

HDG and HDT are output at 9 times per second.

The TALKER Identifier is AP, in all cases. All messages have valid checksums.

The PCMS sentence is output, once per second, if the Vessel Type in the Dockside Setup menu is set to Sail.

Example:

\$PCMNS, PS,340.0,339.6,M,0.1,0.4,,,*2C

- 1) \$ ⇒ the symbol that starts all NMEA 0183 sentences
- 2) P ⇒ identifies a proprietary sentence
- 3) CMN ⇒ the identifier assigned to ComNav Marine Ltd. by NMEA
- 4) S ⇒ status type sentence
- 5) Mode: SB ⇒ **STANDBY** mode, PS ⇒ **POWER STEER** mode, AP = **AUTO** mode, NA = **NAV** mode
- 6) Commanded Heading, degrees
- 7) Actual heading, degrees
- 8) Units of heading: M ⇒ Degrees Magnetic, T ⇒ Degrees True
- 9) Commanded Rudder Angle
- 10) Actual Rudder Angle
- 11) ALC corrected heading
- 12) W ⇒ mode active (field is blank if not)
- 13) L ⇒ ALC active
- 14) Checksum, as per NMEA 0183 standard

Appendix 3

Error Messages

There are a number of different error messages that display for varying reasons and at different times in the P4 autopilot system. These messages are displayed on the Control Head screen, and are usually accompanied by an audible alarm.

The following errors are classified as warnings. Operation of the autopilot continues normally. The error messages may be temporarily suppressed by pressing the **ENTER** button. They are automatically cancelled should the condition that caused them be removed.

Message	Description
COURSE ERROR	The vessel is in AUTO, WORK or NAV modes, and has been off the commanded course by more than 20° for more than 30 seconds. The vessel is in mode, and the angle of the has been more than 20° different than the commanded angle, for more than 30 seconds. Adjust steering parameters to prevent this.
EEPROM ERROR	The system has detected a non-fatal error in one of the memory devices on the SPU. Contact your ComNav Dealer for repair service at your earliest convenience.
NO AUX #1	The system previously detected an auxiliary connected to J10 (but cannot detect it now). Check all wiring.
TURN RATE HIGH	The measured rate of turn of the vessel has exceeded the Turn Rate set in the Auto menu.
TURN RATE LOW	The measured rate of turn of the vessel is much lower than the Turn Rate set in the Auto menu.
WAYPOINT ARRIVED	The Navigation System used in NAV mode has sent a message to the P4 indicating that the vessel has entered the arrival circle around the active waypoint.
XTE OVER LIMIT	The Cross-Track Error limit set in the Nav menu has been exceeded. Adjust steering parameters to prevent this. Also, ensure "XTE Sense" in the Nav menu is set correctly.

Table 8 – Warning Messages

The following messages are classified as “severe” errors. Typically, these messages describe a condition that prevents normal operation in the current mode, but operation in other modes may still be possible. The error messages may be temporarily suppressed by pressing the **ENTER** button. They are automatically cancelled should the condition that caused them be removed.

Message	Description
COMPASS ERROR	The P4 cannot read the Analog compass specified in the Standby menu under Compass Source. Check compass wiring.
FAULTY AUX #1	The P4 SPU has detected a problem in communicating with an auxiliary connected to J10 . Check all wiring.
HIGH TEMPERATURE	The SPU circuitry has become too hot, typically due to excessive current demands. Check all wiring and verify that all output loads (solenoids, pump motors, etc) are within the specifications given for the SPU. Also, ensure that the SPU has adequate ventilation.
INVALID CRS DATA	Valid NMEA 0183 Course data has not been received at NAV1 or NAV2 for ~28 seconds.
INVALID SPEED DATA	Valid NMEA 0183 Speed data has not been received at NAV1 or NAV2 for ~28 seconds.
	Check that the Navigation System sending the data is turned on and functioning properly. Check the wiring between the system and the SPU.
INVALID HEADING	If an Analog Compass is selected as the Compass Source in the Standby menu, this message indicates that the signals from the compass are faulty. Check the wiring between the Compass and the SPU.
	If an NMEA 0183 Compass or other source of Heading data (NAV1 or NAV2 in the Standby menu) is selected as the Compass Source, this message indicates that no valid Heading sentences have been received for ~28 seconds. Check that the device is turned on and functioning properly. Check the wiring between the device and the SPU.
NO NAV DATA	The SPU has not been able to detect, for ~32 seconds, at the Nav Source specified in the Nav menu, the NMEA 0183 navigation information it needs to operate in NAV mode.
NO SPEED DATA	The SPU has not been able to detect, for ~32 seconds, at the Speed Source specified in the Auto menu, the NMEA 0183 Speed data it needs to operate in AUTO or WORK mode .
	Check that the device sending the data is turned on and functioning properly. Check the wiring between the device and the SPU.

Table 9 – Error Messages

The following messages indicate a serious problem. Operation of the autopilot cannot continue until the problem is resolved.

Message	Description
NO LINK	The current P4 controller is not paired or connected to the SPU in the system. check connections, Terminators. Go into main menu for system config. function.
BATTERY TOO HIGH	Battery voltage has risen above ~40 VDC. Check all wiring and charger systems.
NO COMMAND HEAD	The main Control Head is not responding to the SPU. Check all wiring.
FUSE F2 FAULTY	Fuse F2 on the SPU has blown. This fuse supplies current to the drive outputs. Check all wiring and verify that all output loads (solenoids, pump motors, etc) are within the specifications given for the SPU. Replace the fuse with the same type only.
LOW BATTERY	The P4 has detected that the battery supply voltage is less than ~10 VDC, which is too low to continue safe operation. Check all wiring as well as the battery/batteries.
ROM ERROR	The P4 has detected a problem in its program memory. Return the unit to your ComNav Dealer for repair.
RFU NOT FOUND	The P4 cannot detect the presence of a Rudder Follower Unit. Check all RFU wiring. If no faults are found, the RFU may be defective. Contact your ComNav Dealer for repair advice or replacement.
DATABASE ERROR	The P4 has detected a problem in its program memory after software update due to incompatibility. Contact ComNav for advice.

Table 10 – Critical Error Messages

Appendix 4

Diagnostic LEDs

The Signal Processor Unit is equipped with a number of Light-Emitting Diode (LED) lamps that can assist in trouble-shooting should a problem arise with the autopilot system. To observe the LEDs, remove the metal cover on the Diagnostic section.

LED	Description
ALARM	On whenever there is an alarm condition on the SPU. Lights in conjunction with the audible alarm.
BATT PWR	A general indication of the Battery Power supplied to the SPU. Should be on whenever the autopilot is turned on.
DRV PWR	An indication of the power available for the output Drive. Drive Power should be brightly lit whenever the autopilot is on. If it is off, check fuse F2.
VCC	VCC is the voltage supplying the logic circuits on the SPU. The voltage is nominally 5.25 VDC, and can be measured at test point TP3 with respect to ground (GND).
SW'D B+	This indicator will be on whenever the Switched B+ output is turned on.
SW'D GND	This indicator will be on whenever the Switched Ground output is turned on.
M1/PORT	For systems that utilize Solenoid steering valves, this LED will be lit whenever the solenoid is activated. For Reversing Motor systems, this LED will be shut off whenever the motor is activated in one direction (which direction depends on how the reversing motor was plumbed in and wired).
M2/STBD	For systems that utilize Solenoid steering valves, this LED will be lit whenever the solenoid is activated. For Reversing Motor systems, this LED will be shut off whenever the motor is activated in the opposite direction to the M1 output.
NMEA 0183 IN #1	This LED will be lit whenever the autopilot receives serial data on the NAV1 input. Note that this indicator only shows that data was received. It does not mean that the data received is valid. Typically, this LED will flash at a rate of about once per second for regular data from a GPS or Chart plotter; it will flash at a rate of about 10 times per second when connected to a heading source such as an NMEA compass. If the LED does not flash and you are sure the sending device is sending data, try reversing the wires from the device connected to J9 – NAV I/O .
NMEA 0183 IN #2	This LED operates identically to the NMEA 0183 IN #1, but shows the reception of data for the NAV2 input.
NMEA 0183 OUT	This LED flashes whenever NMEA 0183 serial data is sent out of the SPU. During normal operation, this LED will flash at a rate of about ten times per second.
ComNav Network RX	This LED is reserved for possible future use.
ComNav Network TX	This LED is reserved for possible future use.

Table 11 – Diagnostic LEDs

Appendix 5

Upgrading Firmware

The P4 Advanced Autopilot System is the result of extensive development and testing programs.

ComNav is constantly doing research and development related to our Autopilot Systems. From time to time, this can result in new features and benefits that can be incorporated into an existing system installation, in the field – by a ComNav Dealer, or even by the vessel operator.

For the P4 system, this is done with a Firmware. The Firmware link is available from your authorised dealer. The Link will provide intuitive instructions on how to download latest firmware to install the Upgrade. Contact your ComNav Dealer for more information.

Caution! *Be sure to read all of the documentation accompanying the Firmware Upgrade instructions, so you understand all of the operational and performance changes that may occur as a result of the Upgrade.*

Appendix 6

General Specifications

Parameter	Specification
Dimensions	
SPU	218x 152 x 62 mm (10.6" x 5.6"x 2.4")
Bracket Mount Head	157 x 118 x 73 mm (6.2 x 4.6 x 2.9") @ 20° max tilt – add 28 mm (1.1") in width for bracket knobs
Flush-Mount Head	165 x 122 x 12 mm (6.5 x 4.8 x .47") – add 11 mm (.43") for Control Knob and 41 mm (1.6") behind surface to clear rear of Head (not incl. cable)
Display	214mmx 145mm 35mm (8.4"x5.7"x1.9")
Colour Head	Sunlight viewable LED backlit, 640 x 480 VGA
Operating Voltage	12/24 VDC
Power Consumption	
SPU	400 mADC
Control Head	350 mADC
Drive Output	20 Amps (max)
Navigational Interface	NMEA 2000 compliant - Network
NAV1 input	NMEA 0183 compliant, optically isolated, 4800 Baud
NAV2 input	NMEA 0183 compliant, optically isolated, auto-baud detecting (4800, 9600, 19.2K and 38.4K Baud)
NMEA 0183 output	Heading (10x per second) and Autopilot status (1x per second), NMEA 0183 compliant, RS-422 compliant, RS-485 compliant, 4800 Baud, 8 data bits, no parity, one stop bit
Course Detection	0.1°
Course Resolution	
AUTO mode	1°
NAV mode	0.1°
External Rudder Angle Indicator	Supports up to five 500µA instruments
Jog Lever Input	Yes
Rudder Follower Input	1.0 – 4.0 VDC centered at 2.5 VDC.
Control Head cable length	6 metres Drop cable standard

Table 12 – General Specifications

Appendix 7

Compass Safe Distances

The following Compass Safe Distances were determined using a UKAS calibrated 23 Axis Magnetometer, for both standard compasses and steering/emergency compasses.

ComNav PN	Description	Standard Compass Limit 5.4°/H	Steering Compass Limit 18°/H
20140002	Signal Processing Unit (SPU)	28 cm	16.5 cm
30140001	Control Head	32 cm	21 cm
20310033	TS4 Tiller steering Remote	31 cm	18 cm
20310034	NF4 Jog Lever	13 cm	8 cm
20330008	Medium Duty Rotary Rudder Follower	20 cm	8 cm
20330012	Heavy Duty Rotary Rudder Follower	62 cm	40 cm

H = horizontal flux density in μT

Table 13– Compass Safe Distances

CE Compliance (European Conformity)

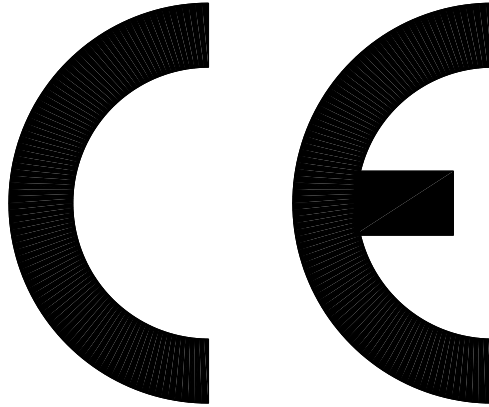

This product has been tested and is in compliance with the Electro-Magnetic Compatibility (EMC) standards of the European Community, and bears the CE label. It has been tested according to the applicable sections outlined under:

Technical standard #IEC945/EN60945,
Marine Navigation Equipment,
General Requirements

Applicable sections for methods of testing and required test results are:

- | | |
|-------------------------|--|
| ▪ Section 4.5.4: | Radiated Interference |
| ▪ Section 4.5.4: | Immunity to Electro-Magnetic Environment |
| ▪ Annex A, Section A.3: | Immunity to Conducted Audio Frequencies |
| ▪ Annex A, Section A.4: | Immunity to Earth Lead Coupling |
| ▪ Annex A, Section A.6: | Immunity to Radiated Interference |

Test results and a declaration of conformity are on file at the ComNav Head Office.

ComNav Marine Ltd.
#15 - 13511 Crestwood Place
Richmond, BC V6V 2G1
Canada

Warranty Information

Limited Warranty Agreement

Congratulations! You have purchased sophisticated and sensitive marine equipment (the "Equipment") manufactured by ComNav Marine Ltd. of #15 - 13511 Crestwood Place, Richmond, British Columbia, Canada, V6V 2G1 ("ComNav").

LIMITED ONE YEAR WARRANTY

ComNav warrants to the Purchaser, provided that the recommended installation and maintenance procedures set forth in the manual that has been provided with the Equipment (the "Manual") have been followed, and subject always to the other provisions of this Agreement, that the Equipment is free from defects in workmanship and materials under normal use and service and will perform substantially in accordance with the specifications set forth in the Manual for a period of one (1) year from the date of purchase of the Equipment by the Purchaser.

EXTENDED THREE-YEAR LIMITED WARRANTY

If;

- a) the Equipment is installed:
 - i. by an authorized ComNav Dealer; or
 - ii. by someone other than an authorized ComNav Dealer, and such installation has been inspected by an Authorized ComNav Dealer;

and

- b) the Limited Warranty Registration Card has been returned to ComNav within 14 days of the date of purchase of the Equipment by the Purchaser with Part I thereof having been completed by the Purchaser, and with the Extended Limited Warranty Card having been completed and signed by an authorized ComNav Dealer and returned to ComNav within 14 days of that inspection;

then;

ComNav warrants to the Purchaser that the Equipment is free from defects in workmanship and materials under normal use and service and will perform substantially in accordance with the specifications set forth in the Manual for a period of three (3) years from the date of purchase of the Equipment, subject to the other provisions of this Agreement.

NO OTHER WARRANTIES

TO THE MAXIMUM EXTENT PERMITTED BY APPLICABLE LAW, COMNAV DISCLAIMS ALL OTHER WARRANTIES AND CONDITIONS, EITHER EXPRESSED OR IMPLIED, STATUTORY OR OTHERWISE WITH RESPECT TO THE EQUIPMENT, INCLUDING BUT NOT LIMITED TO IMPLIED WARRANTIES OR CONDITIONS OF MERCHANTABILITY AND FITNESS FOR THE ORDINARY PURPOSES FOR WHICH THE EQUIPMENT IS USED OR FITNESS FOR A PARTICULAR PURPOSE AND ANY OTHER OBLIGATIONS ON THE PART OF COMNAV, ITS EMPLOYEES, SUPPLIERS, AGENTS, OR REPRESENTATIVES.

NO LIABILITY FOR CONSEQUENTIAL DAMAGES

TO THE MAXIMUM EXTENT PERMITTED BY APPLICABLE LAW, IN NO EVENT SHALL COMNAV, ITS EMPLOYEES, SUPPLIERS, OR REPRESENTATIVES BE LIABLE FOR ANY DAMAGES WHATSOEVER, INCLUDING WITHOUT LIMITATION DAMAGE FROM COLLISION WITH OTHER VESSELS OR OBJECTS, INJURY TO ANY PERSON OR PERSONS, DAMAGE TO PROPERTY, LOSS OF INCOME OR PROFIT, BUSINESS INTERRUPTION, OR ANY OTHER CONSEQUENTIAL, INCIDENTAL, RESULTING PUNITIVE, OR SPECIAL DAMAGES ARISING OUT OF THE USE OF OR INABILITY TO USE THE EQUIPMENT, INCLUDING THE POSSIBLE FAILURE OR MALFUNCTION OF, OR DEFECTS IN THE EQUIPMENT, OR ANY PART THEREOF, EVEN IF COMNAV HAS BEEN ADVISED OF THE POSSIBILITY OF SUCH DAMAGES. SOME STATE/JURISDICTIONS DO NOT ALLOW THE EXCLUSION OR LIMITATION OF CONSEQUENTIAL OR INCIDENTAL DAMAGES, SO THE ABOVE LIMITATION MAY NOT APPLY TO THE PURCHASER.

REMEDIES NOT TRANSFERABLE

The Purchaser's remedies under this Agreement only apply to the original end-user of the ComNav Equipment, being the Purchaser, and only apply to the original installation of the Equipment. The Purchaser's remedies under this Agreement are not transferable or assignable by the Purchaser to others in whole or in part.

NOTICE OF DEFECT

The Limited Warranty and the Extended Warranty will not apply with respect to any defective Equipment unless written notice of such defect is given to ComNav, by mail to the address for ComNav set forth above, or by facsimile to ComNav at 604-207-8008, and is received by ComNav within 10 days of the date upon which the defect first became known to the Purchaser. Notices sent by mail will be deemed to be received by ComNav on the seventh (7th) day first following the date of posting in North America and on the tenth (10th) day next following the date of posting anywhere else in the world. Notices sent by facsimile will be deemed to be received by ComNav on the date of transmission with appropriate answerback confirmation.

WARRANTY LIMITATIONS

Reversing Pumps & Motors, Hydraulic Linear Actuators, Watch Alarms & Motor Control boxes which may comprise part of the Equipment are warranted by ComNav for a period of two (2) years under the Extended Limited Warranty described above. All Remote Controls, Remote Cables, Jog Switches, Analog meters (rudder angle indicators), Rudder Angle Indicator Systems & Accessories, Magnetic Compasses & Accessories, Constant Running Pumps, Engine Driven Pumps, Hydraulic Manifolds & Hydraulic Steering are warranted by ComNav for a period of one (1) year under the Limited Warranty described above.

IMPLIED WARRANTIES

Any implied warranties with respect to the Equipment are limited to one (1) year. Some states/jurisdictions do not allow limitations on how long an implied warranty lasts, so the above limitation may not apply to the Purchaser.

CUSTOMER REMEDIES

ComNav's entire liability and the Purchaser's exclusive remedy against ComNav for the defective Equipment shall be, at ComNav's option, either: (a) repair or replacement of the defective Equipment under the warranties set forth in this Agreement, or, (b) refund of the purchase price of the defective Equipment, all pursuant to and in accordance with the conditions set forth below:

1. If the Equipment, or any part thereof, proves to be defective within the relevant warranty period, the Purchaser shall do the following:
 - a. contact ComNav by phoning 604-207-1600 to discuss the nature of the problem and obtain shipping instructions (many times a satisfactory solution can be reached without returning the item); and
 - b. prepare a detailed written statement of the nature of the circumstances of the defect, to the best of the Purchaser's knowledge, including the date of purchase of the Equipment, the place of purchase, the name and address of the installer, and the Purchaser's name, address and telephone number to be sent, along with proof of purchase, to ComNav;
2. If upon examination by either ComNav or an authorized ComNav Dealer, the defect is determined to result from defective workmanship or material and if the defect has occurred within the relevant warranty period set forth above, the Equipment or the defective parts thereof shall be repaired or replaced, at ComNav's sole option, without charge, and shall be returned to the Purchaser at ComNav's expense. Return delivery will be by the most economical means. Should the Purchaser require that the Equipment be returned by a faster method, the costs incurred by the expedient delivery will be pre-paid by the Purchaser;
3. No refund of the purchase price for the Equipment will be made to the Purchaser unless ComNav is unable to remedy the defect after having a reasonable number of opportunities to do so. Prior to the refund of the purchase price, the Purchaser must submit a statement in writing from an Authorized ComNav Dealer that the installation instructions in the manual have been complied with in full and that the defect remains.
4. Warranty service shall be performed only by ComNav or an Authorized ComNav Dealer. Any attempts to remedy the defect by anyone else shall render the warranties set forth in this Agreement void;
5. Charges for overtime, standby, holiday and per diem will not be paid by ComNav and are specifically excluded from the warranties set forth in this Agreement. ComNav may, under special circumstances, and with ComNav's PRIOR approval, pay ONE TIME travel costs. Any cost of ferry, boat hire, or other special means of transportation must have prior approval from ComNav. ComNav reserves the right to refuse service charges in excess of one hour if the technician has not contacted ComNav's service department for assistance. Travel cost allowance to service certain Equipment with a suggested retail price of below \$2,500.00 (Canadian funds or equivalent) is not authorized. If repairs are necessary, these products must be forwarded to ComNav or an authorized ComNav Dealer at Purchaser's expenses and will be returned as set out in **CUSTOMER REMEDIES**, Item 2;
6. There shall be no warranty for defects in, or damages to, the Equipment caused by:
 - a. faulty installation or hook-up of the Equipment;
 - b. abuse, misuse or use of the Equipment in violation of the instructions set forth in the Manual;
 - c. shipping, alterations, incorrect and/or unauthorized service;
 - d. accident, exposure of the Equipment to excessive heat, fire, lightning, salt or fresh water spray, or water immersion except for Equipment specifically designed as, and stated in the Manual to be, waterproof. Water damage to the Equipment due to failure to cover unused receptacles is specifically excluded from any warranty set forth in this Agreement; and
 - e. improper or inadequate ancillary or connected equipment;
7. This warranty does not cover routine system checkouts, alignment, or calibration unless the service has been authorized in writing by ComNav PRIOR to its commencement; and
8. No Equipment shall be repaired or replaced under warranty if the serial number of that Equipment has been removed, altered or mutilated.

CHOICE OF LAW AND JURISDICTION

This Agreement is governed by the laws of the Province of British Columbia, Canada. If you acquired the Equipment outside of Canada, each of the parties hereto irrevocably attorn to the jurisdiction of the courts of the Province of British Columbia, Canada and further agree to settle any dispute, controversy or claim arising out of or relating to this Limited Warranty, or the breach, termination, or invalidity of it, by arbitration under the rules of the British Columbia International Commercial Arbitration Centre ("BCICAC"). The appointing authority shall be BCICAC [or, if the BCICAC shall cease to exist, the Chief Justice of the Supreme Court of British Columbia]. BCICAC shall administer the case in accordance with BCICAC Rules. There shall be one arbitrator and the place of arbitration shall be Vancouver, British Columbia.

The United Nations Convention on Contracts for the International Sale of Goods Act, S.B.C 1990, c. 20, and any other statutory enactments of the United Nations Convention on Contracts for the International Sale of Goods do not apply to this Agreement.

THIS LIMITED WARRANTY GIVES THE PURCHASER SPECIFIC LEGAL RIGHTS. THE PURCHASER MAY ALSO HAVE OTHERS WHICH VARY FROM STATE/JURISDICTION TO STATE/JURISDICTION.

This Agreement is a legal contract between you (the "Purchaser") and ComNav. By retaining the Equipment for more than thirty (30) days and/or installing and/or using the Equipment, the Purchaser agrees to be bound by the terms of this Agreement. If the Purchaser does not agree to be bound by the terms of this Agreement, the Purchaser may return the Equipment in the same condition in which it was received for a full refund (less shipping and handling costs) within thirty (30) days of purchase.

WARNING

The Equipment is an aid to navigation only. It is not intended or designed to replace the person on watch. A qualified person should always be in a position to monitor the vessel's heading, watch for navigational hazards and should be prepared to revert to manual steering immediately if an undesired change of heading occurs, if the heading is not maintained within reasonable limits, or when navigating in a hazardous situation.

**ALWAYS REMEMBER:
WHENEVER UNDER WAY, A QUALIFIED PERSON ON WATCH IS REQUIRED BY LAW.**

User Notes and Settings

User Settings

Once your P4 system has been installed and set up correctly, make a record of all the settings for future reference, in the table below.

Parameter	Range	Default Value	User Settings 1	User Settings 2
Dockside Setup menu				
Reset	<i>press ENTER Knob to do</i>	<i>n/a</i>		
Vessel type	Displ, Semi, Plane, Stern, Sail	Displ		
An. Compass type	None, Mag, Flux, Fixed, Float,	None		
Compass setup	<i>press ENTER Knob button to do</i>	<i>n/a</i>		
Drive setup	<i>press ENTER Knob to do</i>	<i>n/a</i>		
Exit	<i>press Enter Knob to do</i>	<i>n/a</i>		
Alarm O/P	None, SW'D B-, SW'D B+	None		
External Alarm Type	All, Watch	All		
Thrust Type (CT7)	None, On/Off, Prop.	None		
Thrust MIN (CT7)	0 – 70%	0		
Thrust MAX (CT7)	Thrust min to 100%	0		
Language	English, Français, Español, Íslenska, Italiano, Norsk, Deutsche, Dansk			
Standby Menu				
Station Lock	Lock, Unlock	Unlock		
Default Turn	U-Turn, Circle, M.O.B., Fishzag,	U-Turn		
Compass Source	Analog, NAV1, NAV2, N2K	NAV1		
Compass Cal	0 – 359°	<i>Set at Runtime</i>		
Watch Alarm	Off, 1 – 30	Off		
Fishzag time	30 – 300	60		
Battery	<i>Read only value</i>	<i>n/a</i>		

Table 14 - User Settings

Parameter	Range	Default Value	User Settings 1	User Settings 2
Power Steer Menu				
Stdbby/P. Str Rudder Limits	Off, or 5° up to physical limits from Dockside Setup	Off		
Auto/Nav Rudder Limits	Off, or 5° up to physical limits from Dockside Setup	Off		
RAI Offset	0° – 15°	0		
Auto Menu				
Rudder Gain	1 – 10	8, 5		
Counter Rudder	0 – 10	3, 3		
Seastate	Auto, 1 – 10	A, A		
Turn Rate	0.1 – 20	8, 5		
Parameter Set	Lo, Hi, Auto	Auto		
Speed Trip Pt.	1 – 20	10		
Speed Source	NAV1, NAV2	NAV1		
ALC	On, Off	Off		
Thruster Assist <i>(only if Thrust Type is not None)</i>	Off, or 1 – 7 in 0.5 steps	Off		
Thruster Gain <i>(only if Thrust Type is not None)</i>	Low, Med. High	Low		
Nav Menu				
Nav Source	NAV1, NAV2, N2K	NAV1		
XTE Limit	0.01 – 3.0, step 0.01	0.25		
Waypoint Arrival	Silent, Manual, Auto	Auto		
Correction	XTE, CTS, Both	Both		
XTE Sense	Norm, Rev	Norm		
Max Correction	30° – 90°	60°		

Parameter	Range	Default Value	User Settings 1	User Settings 2
Work Menu				
Rudder Bias	Auto/Nav rudder limit or physical limit	<i>Set at Runtime</i>		
Autotrim	Off, On	Off		
Work Trip Pt.	1 – 10	2		
Rudder Scale	0.25 – 3.00, step 0.25	1.00		
Work Mode State	A_Rdy, A_On, M_Rdy, M_On	<i>Set at Runtime</i>		

