



USER GUIDE

Sist endret: 10.02.2020

Rev: 1.0

PRONAV V200S

GPS COMPASS

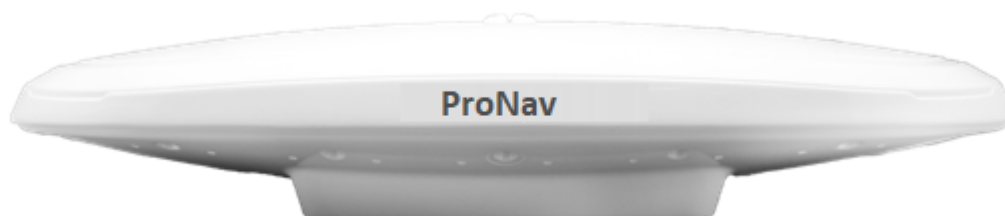

Table of Contents

Device Compliance, License and Patents	4
Terms and Definitions	6
Chapter 1: Introduction.....	7
Overview.....	7
Product Overview	8
Key Features	11
What’s Included in Your Kit.....	12
Using PocketMax to Communicate with the V200s.....	13
Firmware Upgrades	16
Chapter 2: Mounting the V200s	20
Overview.....	20
Mounting the V200s.....	22
Surface-mounting the V200s.....	31
Pole-mounting the V200s.....	35
Chapter 3: Connecting the V200s.....	36
Ports	36
Selecting Baud Rates and Message Types.....	38
Connecting the V200s to External Devices	39
Chapter 4: Understanding the V200s	41
Overview.....	41
GNSS Overview	42
Differential Operation	43
SBAS Tracking	43
Atlas L-band.....	43
Supplemental Sensors	44
Time Constants.....	46
Chapter 5: Operating the V200s.....	47
Overview.....	47
Powering the V200s	49
Appendix A: Troubleshooting.....	49
Overview.....	49

Troubleshooting	50
Appendix B: Technical Specifications	52
Technical Specifications	52
V200s Technical Specifications.....	54
Appendix C: Commands and Messages.....	57
Overview.....	57
Serial Commands.....	59
NMEA 0183 Messages.....	62
Binary Messages.....	66

Device Compliance, License and Patents

Device Compliance This device complies with part 15 of the FCC Rules. Operation is subject to the following two conditions:

1. This device may not cause harmful interference, and
2. this device must accept any interference received, including interference that may cause undesired operation.

This product complies with the essential requirements and other relevant provisions of Directive 2014/53/EU. The declaration of conformity may be consulted at [HTTPS://HEMISPHEREGNSS.COM/ABOUT-US/QUALITY-COMMITMENT](https://hemispheregnss.com/about-us/quality-commitment).

Copyright Notice Copyright Hemisphere GNSS, Inc. (2020). All rights reserved. No part of this manual may be reproduced, transmitted, transcribed, stored in a retrieval system or translated into any language or computer language, in any form or by any means, electronic, mechanical, magnetic, optical, chemical, manual or otherwise, without the prior written permission of Hemisphere GNSS.

Trademarks Hemisphere GNSS®, the Hemisphere GNSS logo, TRACER™, Crescent®, Eclipse™, e-Dif®, L-Dif™, PocketMax4™, S320™, SBX-4™, Vector™, XF1™, and XF2™ are proprietary trademarks of Hemisphere GNSS, Inc. Other trademarks are the properties of their respective owners.

Patents Hemisphere GNSS products may be covered by one or more of the following patents:

Patents			
6111549	6876920	7400956	8000381
6397147	7142956	7429952	8018376
6469663	7162348	7437230	8085196
6501346	7277792	7460942	8102325
6539303	7292185	7689354	8138970
6549091	7292186	7808428	8140223
6711501	7373231	7835832	8174437
6744404	7388539	7885745	8184050
6865465	7400294	7948769	8190337
8214111	8217833	8265826	8271194
8307535	8311696	8334804	RE41358

Australia Patents	
2002244539	2002325645
2004320401	

Continued on next page

Device Compliance, License and Patents, Continued

Notice to Customers

Contact your local dealer for technical assistance. To find the authorized dealer near you:

Hemisphere GNSS, Inc
8515 East Anderson Drive
Scottsdale, AZ 85255 USA
Phone: (480) 348-6380
Fax: (480) 270-5070
PRECISION@HGNSS.COM
WWW.HGNSS.COM

Technical Support

If you need to contact Hemisphere GNSS Technical Support:

Hemisphere GNSS, Inc.
8515 East Anderson Drive
Scottsdale, AZ 85255 USA
Phone: (480) 348-6380
Fax: (480) 270-5070
SUPPORT.HGNSS.COM

Documentation Feedback

Hemisphere GNSS is committed to the quality and continuous improvement of our products and services. We urge you to provide Hemisphere GNSS with any feedback regarding this guide, by opening a support case at the following website: HGNSS.COM

Terms and Definitions

Introduction

The following table lists the terms and definitions used in this document.

V200s terms & definitions

Term	Definition
Activation	Activation refers to a feature added through a one-time purchase.
Atlas	Atlas is a subscription-based service provided by Hemisphere that enables the V200s to achieve sub-meter accuracy without a base station or datalink.
BeiDou	BeiDou is a Chinese satellite-based navigation system.
DGPS/DGNSS	Differential GPS/GNSS refers to a receiver using Differential Corrections.
Differential Corrections	A method of improving precision of a GNSS rover. Two GNSS receivers placed in a nearby area will have similar error. A base station is placed over a known point.
Firmware	Firmware is the software loaded into the receiver that controls the functionality of the receiver and runs the GNSS engine.
GALILEO	Galileo is a global navigation satellite system implemented by the European Union and European Space Agency.
GLONASS	Global Orbiting Navigation Satellite System (GLONASS) is a Global Navigation Satellite System deployed and maintained by Russia.
Heading	The vector created from the primary to secondary antenna. It points to the direction that the receiver is facing
Vector Receiver	A Hemisphere GNSS receiver capable of providing heading

Chapter 1: Introduction

Overview

Introduction

This User Guide provides information to help you quickly set up your V200s. You can download this manual from the Hemisphere GNSS website at WWW.HGNSS.COM.

Contents

Topic	See Page
Product Overview	8
Key Features	11
What's Included in Your Kit	12
Using PocketMax to Communicate with the V200s	13
Firmware Upgrades	16

Product Overview

Product overview

The V200s Vector™ GNSS Compass supports GPS, GLONASS, Galileo, BeiDou, and QZSS satellites using Hemisphere GNSS' Crescent Vector H220™ GNSS module. This User Guide is available for download from www.HGNSS.com.

Note: When referring to both the V200s Vector™ GNSS Compass, this manual uses the term V200s.

The multi-GNSS V200s supports GPS, GLONASS, Galileo, BeiDou, and QZSS and offers an amazing world-wide 30 cm (RMS) accuracy via Hemisphere's Atlas GNSS global correction service.

The V200s offers an incredible combination of simple installation, small form factor, and amazing performance. The compass - measuring only 35 cm in length - mounts easily to a flat surface or pole. The stability and maintenance-free design of the V200s provides simple integration into autopilots, chart plotters, and AIS systems.

There are no mechanical parts such as gimbals or a rotating motor, so the V200s Compass is free from routine maintenance. Heading is determined from GNSS, and there is no need to wait for settling time, gyrocompass calibration and speed corrections. Vector performance is not affected by geomagnetism, making it the perfect solution for any marine application.

The V200s is an integrated system that houses the following:

- Crescent Vector H220 module
- Dual mGNSS, multipath-resistant antennas
- Power supply
- Six-axis sensor

The sensor is present to improve system performance and to provide backup heading information in the event a GNSS heading is not available due to signal blockage. The sensor provides a substitute heading, accurate to within 1° per minute for up to three minutes.

Continued on next page

Product Overview, Continued

**Product
overview,
continued**

The V200s's GPS antennas are separated by 20 cm between phase centers, resulting in a heading performance of better than 0.75° RMS (with High Accuracy Heading activated). The V200s can provide heading and positioning updates of up to 50 Hz and delivers positioning accuracy of 0.6 m 95% of the time when using differential GPS corrections from Satellite Based Augmentation Systems (SBAS) or Atlas.

The V200s also features Hemisphere GNSS' exclusive Tracer™ technology, which provides consistent performance with correction data. The V200s is less likely to be affected by differential signal outages due to signal blockages, weak signals, or interference when using Tracer.

If you are new to GNSS and SBAS, refer to the [Hemisphere GNSS Technical Reference Manual](#) (for further information on these services and technologies before proceeding).



Figure 1-1: V200s

Continued on next page

Product Overview, Continued

Atlas L-band

Atlas L-band is Hemisphere's industry leading correction service, which can be added to the V200s as a subscription. Atlas L-band has the following benefits:

- **Positioning accuracy** - Competitive positioning accuracies down to 30 cm RMS in certain applications
 - **Positioning sustainability** - Cutting edge position quality maintenance in the absence of correction signals, using Hemisphere's patented technology
-

For more information

For more information about Athena RTK, see:

<https://www.hemispheregnss.com/technology/#athena>

For more information about Atlas L-band, see:

<https://www.hemispheregnss.com/technology/#atlas>

Key Features

V200s key features

Key features of the V200s include:

- L1 GPS, GLONASS, Galileo, BeiDou, QZSS
 - 30 cm RMS world-wide positioning accuracy with Atlas corrections
 - Standard 1.5° and optional 0.75° heading accuracy in small form factor
 - Excellent in-band and out-of-band interference rejection
 - Integrated gyro and tilt sensors help deliver fast start-up times and provide heading updates during temporary loss of satellites
 - Provides heading, positioning, heave, pitch, and roll
-

What's Included in Your Kit

V200s kit Table 1-1 lists the parts included with your V200s. The V200s GNSS Compass and the power/data cable (accessory item) are the only two required components.

Note: The V200s's parts comply with IEC 60945 Section 4.4: "Exposed to the weather."

V200s Parts list The following table lists the part numbers and description for the V200s.

Table 1-1: V200s Parts list

Part No.	Description
804-0162-20	Vector V200s GNSS Compass
940-3141-10	Vector V200s GNSS Compass kit

All the following are accessory items available for purchase separately from your V200s GNSS Compass.

Table 1-2: V200s Accessory list

Part No.	Description
051-0404-10	15 m power/data cable, RA (unterminated)
051-0405-10	15 m power/data cable (unterminated)
710-0162-10	V200 Surface Mounting Kit
710-0166-10	V200 Pole Mounting Kit
710-0167-10	V200 Complete Mounting Kit

Using PocketMax to Communicate with the V200s

Using PocketMax to communicate with the V200s

Use the following steps to set up the V200s communication with PocketMax.

Table 1-3: PocketMax Communication

Step	Action
1	Power on and connect the receiver to your computer's com port. A configuration screen appears prompting you to choose the COM port and baud rate of the receiver.
2	<p>Choose from the following communications settings options:</p> <ul style="list-style-type: none"> • Select COM Port. • If you do not know the baud rate, select the Auto-Baud feature to cycle through all possible baud rates, and click Connect. <div data-bbox="691 824 1257 1249" style="border: 1px solid black; padding: 5px; margin-bottom: 10px;"> </div> <div data-bbox="691 1283 1257 1702" style="border: 1px solid black; padding: 5px;"> </div>

Continued on next page

Using PocketMax to Communicate with the V200s, Continued

Using
PocketMax to
communicate
with the V200s,
continued

Table 1-3: PocketMax Communication (continued)

Step	Action
3	<p>You can monitor your connection status through the message displayed at the bottom of the screen.</p> <p>If you receive a message “Receiver not found...” check your connections, your com port, and your baud rate and try to re-send.</p> 

Continued on next page

Using PocketMax to Communicate with the V200s, Continued

Using PocketMax to communicate with the V200s, continued

Table 1-3: PocketMax Communication (continued)

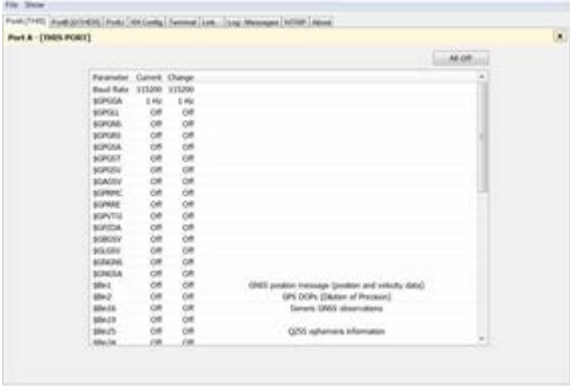
Step	Action
4	<p>The Quick Configuration screen allows you to use “PortA”, “PortB”, and “PortC” tabs to configure the output messages and baud rates of these two ports.</p> <p>The Port displaying “[THIS]” is the port currently connected. “[OTHER]” is the other port. Enable all desired messages for PortA and PortC.</p> <p>Use RxConfig to make basic receiver configurations. To exit the software, click Save Settings and Disconnect. For all other PocketMax questions, please reference the PocketMax User Guide on the HGNSS website.</p> 

Firmware Upgrades

Overview

Periodically, Hemisphere GNSS releases firmware upgrades to improve performance, fix bugs, or add new features to a product. To update the firmware on the V200s:

1. Download the latest version of Hemisphere GNSS RightArm from the following link:

[HTTPS://HGNS.COM/RESOURCES-SUPPORT/SOFTWARE.](https://hgns.com/resources-support/software)

RightArm upgrade

Use the following steps to upgrade the RightArm firmware on your V200s:

Table 1-4: RightArm Upgrade

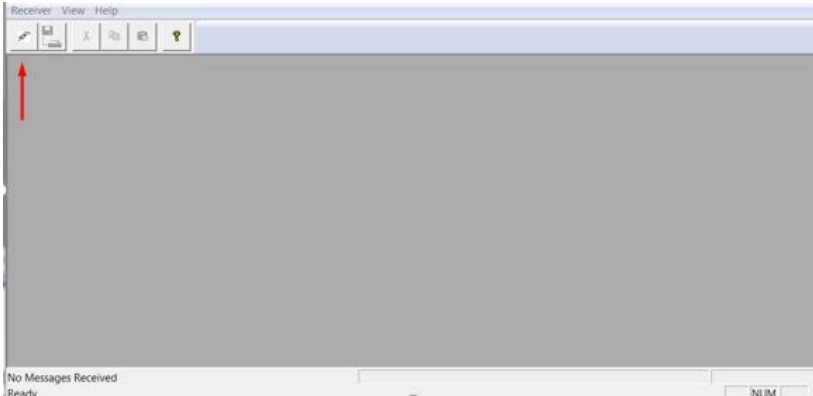
Step	Action
1	<p>Connect the V200s to a computer over serial. Firmware can be loaded over either serial port. Set the baud rate of the serial port you are using to 19200.</p> <p>Launch RightArm.</p> <p>Click the Connect button or navigate to Receiver -> Connect.</p> 

Continued on next page

Firmware Upgrades, Continued

RightArm
upgrade,
continued

Table 1-4: RightArm Upgrade (continued)

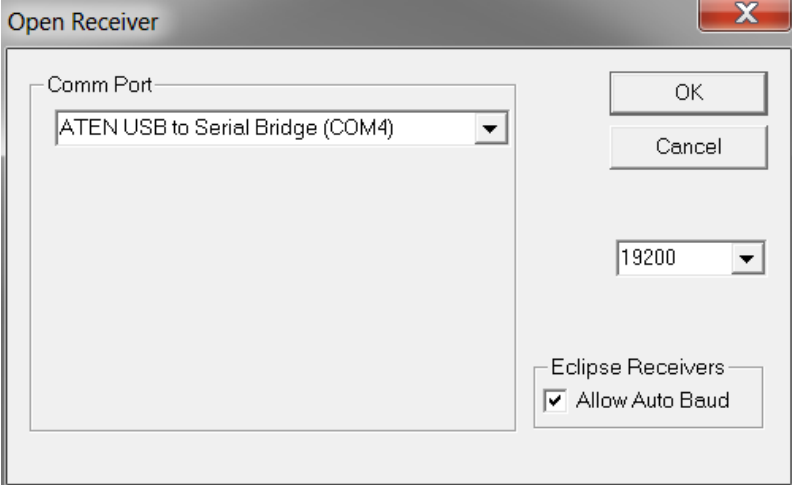
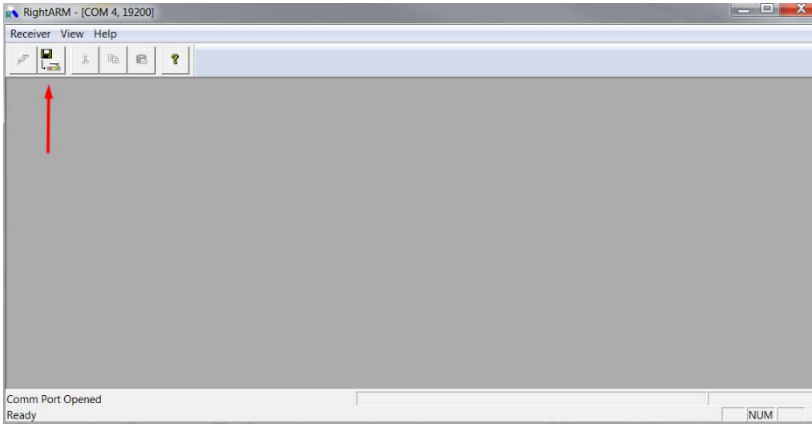
Step	Action
2	<p>Choose the COM port connected to the V200s and click OK.</p>  <p>Note: The baud rate of the serial port should be set to 19200 bps. Select “Allow Auto Baud” to change the baud rate during the firmware upgrade for a faster update.</p>
5	<p>Click the Programming button.</p> 

Continued on next page

Firmware Upgrades, Continued

RightArm
upgrade,
continued

Table 1-4: RightArm Upgrade (continued)

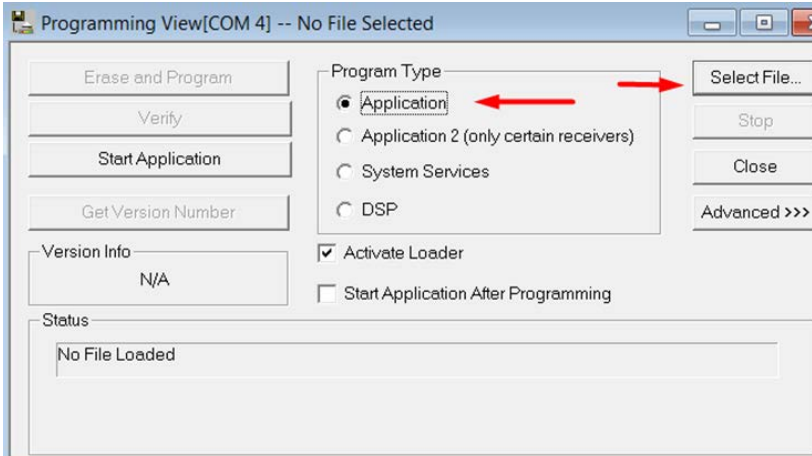
Step	Action
6	<p>Select a Program Type.</p> <p>The V200s has two firmware applications, allowing two different versions of GNSS firmware. Hemisphere GNSS suggests loading the new firmware onto both applications.</p> <p>After the firmware update is completed, check the current GNSS firmware.</p> <p>If the current firmware is not the same as the newly loaded firmware, the V200s could be using the other application. You can switch applications by sending the following command:</p> <p>\$JAPP,OTHER.</p>
7	<p>Choose the Application, and press Select File to select the firmware file.</p> 

Continued on next page

Firmware Upgrades, Continued

RightArm
upgrade,
continued

Table 1-4: RightArm Upgrade (continued)

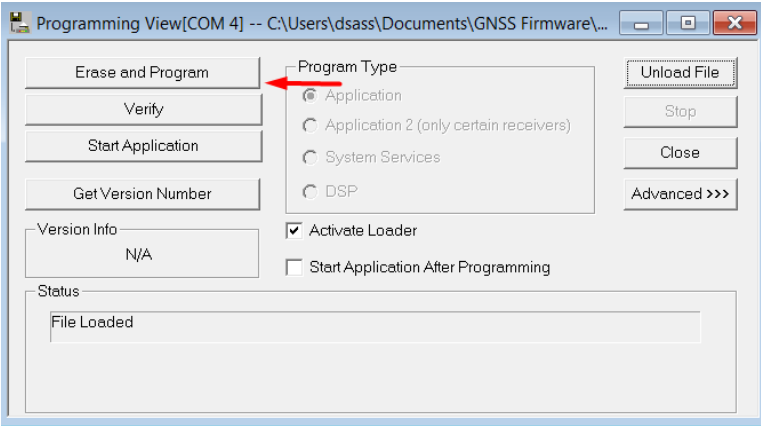
Step	Action
8	<p>Choose the firmware, and click Erase and Program.</p> <p>The Activate Loader checkbox in the Programming View window is selected. After pressing the Erase and Program button, this checkbox will de-select, and the Status field indicates the receiver is in loader mode (ready to receive the new firmware file).</p> 

Continued on next page

Firmware Upgrades, Continued

RightArm
upgrade,
continued

Table 1-4: RightArm Upgrade (continued)

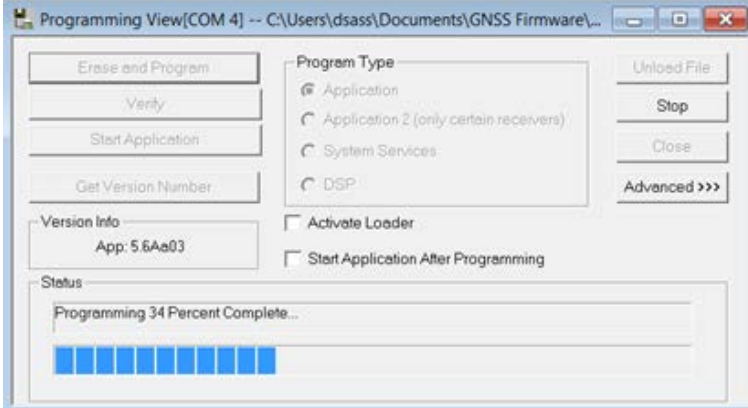
Step	Action
9	<p>Note: If the Activate Loader check box remains selected, power the receiver off and on. When the receiver powers back on, the Activate Loader box should be de-selected.</p> <p>⚠ WARNING: Do not to interrupt the power supply to the receiver, and do not interrupt the communication link between the PC and the receiver until programming is complete. Failure to do so may cause the receiver to become inoperable and will require factory repair.</p> 
10	<p>After completing the firmware update, Hemisphere GNSS suggests repeating this process for the other application.</p>

Chapter 2: Mounting the V200s

Overview

Introduction

This chapter provides instructions on how to mount your V200s receiver.

Contents

Topic	See Page
Mounting the V200s	22
Surface-mounting the V200s	31
Pole-mounting the V200s	35

Mounting the V200s

Introduction

This section provides information on mounting the V200s in the optimal location, orientation considerations, environmental considerations, and other mounting options.

GNSS satellite reception

When deciding where to mount the V200s, consider the following satellite reception recommendations:

- Ensure there is a clear view of the sky available to the V200s so the GNSS and L-band satellites are not masked by obstructions that may reduce system performance.
- Position is based off the primary GNSS antenna located on located on the end opposite the recessed arrow on the underside of the enclosure.
- Locate any transmitting antennas away from the V200s by at least a few meters to ensure tracking performance is not compromised.
- Ensure cable length is adequate to route into the vessel to reach a breakout box or terminal strip.
- Do not locate the antenna where environmental conditions exceed those specified in [Appendix B, Technical Specifications](#) of this document.



Figure 2-1: V200n Underside with recessed arrow

Continued on next page

Mounting the V200s, Continued

VHF interference

VHF interference from such devices as cellular phones and radio transmitters may interfere with GPS operation, however the Vector compass can still track other constellations, maintaining heading and position.

For example, if installing the V200s near marine radios, consider the following:

- VHF marine radio working frequencies (Channels 1 to 28 and 84 to 88) range from 156.05 to 157.40 MHz. The L1 GPS working center frequency is 1575.42 MHz. The bandwidth is +/- 2MHz to +/- 10 MHz, which is dependent on the GNSS antenna and receiver design.
- VHF marine radios emit strong harmonics. The 10th harmonic of VHF radio, in some channels, falls into the GPS working frequency band, which may cause the SNR of GNSS to degrade significantly.
- The radiated harmonic signal strength of different brands/models varies.
- Follow VHF radio manufacturers' recommendations on how to mount their radios and what devices to keep a safe distance away.
- Handheld 5W VHF radios may not provide suitable filtering and may interfere with the V200s's operation if too close.

Before installing the Vector Compass, use the following diagram to ensure there are no nearby devices that may cause VHF interference.

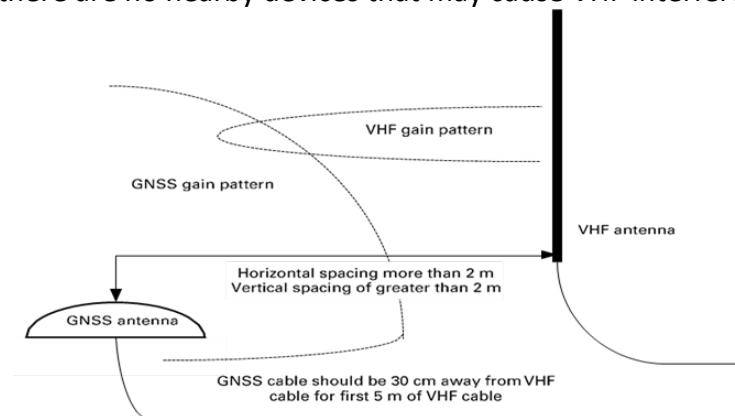

Figure 2-2: V200s distance from nearby VHF radios

Continued on next page

Mounting the V200s, Continued

Environmental considerations

Hemisphere Vector Smart Antennas are designed to withstand harsh environmental conditions; however, adhere to the following limits when storing and using the V200s:

- Operating temperature: -30°C to +70°C (-22°F to +158°F)
 - Storage temperature: -40°C to +85°C (-40°F to +185°F)
 - Humidity: 95% non-condensing
-

Mounting orientation

The V200s outputs heading, pitch, and roll readings regardless of the orientation of the antennas. The relation of the antennas to the vessel's axis determines if you need to enter a heading, pitch, or roll bias. The primary antenna is used for positioning and the primary and secondary antennas, working in conjunction, output heading, pitch, and roll values.

The top of the V200s enclosure incorporates a sight design feature to help you align the enclosure on your vessel. Alignment accuracy is approximately +/- 2°.

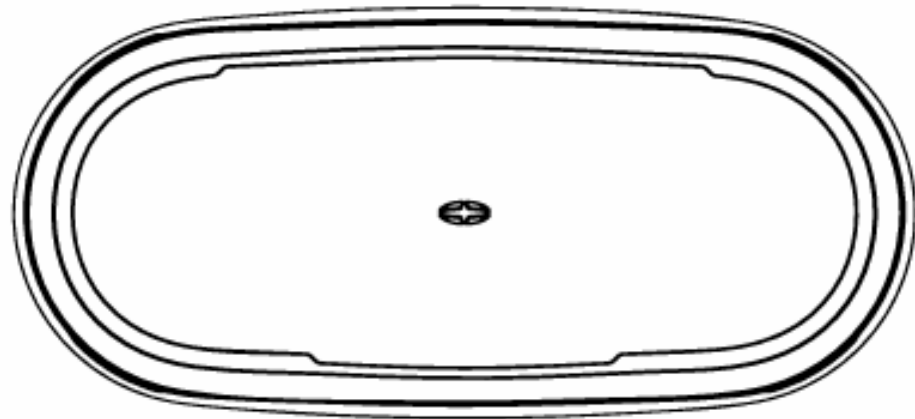

Figure 2-3: Shorter design element

Note: Regardless of which mounting orientation you use, the V200s provides the ability to output the heave of the vessel. This output is available via the \$GPHEV message. For more information on this message refer to the [Hemisphere GNSS Technical Reference Manual](#).

Continued on next page

Mounting the V200s, Continued

Parallel orientation

Parallel installation orients the V200s parallel to, and along the centerline of, the axis of the vessel. **This provides a true heading.** In this orientation:

- If you use a gyrocompass and there is a need to align the Vector smart antenna, you can enter a heading bias in the V200s to calibrate the physical heading to the true heading of the vessel.
 - You may need to adjust the pitch/roll output to calibrate the measurement if the Vector is not installed in a horizontal plane.
-

Perpendicular orientation

You can also install the antennas, so they are oriented perpendicular to the centerline of the vessel's axis. In this orientation:

- Enter a heading bias of +90° if the primary antenna is on the starboard side of the vessel and -90° if the primary antenna is on the port side of the vessel.
 - Configure the receiver to specify the GNSS smart antenna is measuring the roll axis using \$JATT,ROLL,YES.
 - Enter a roll bias to properly output the pitch and roll values.
 - You may need to adjust the pitch/roll output to calibrate the measurement if the Vector is not installed in a horizontal plane.
-

Continued on next page

Mounting the V200s, Continued

Mounting
orientation
example

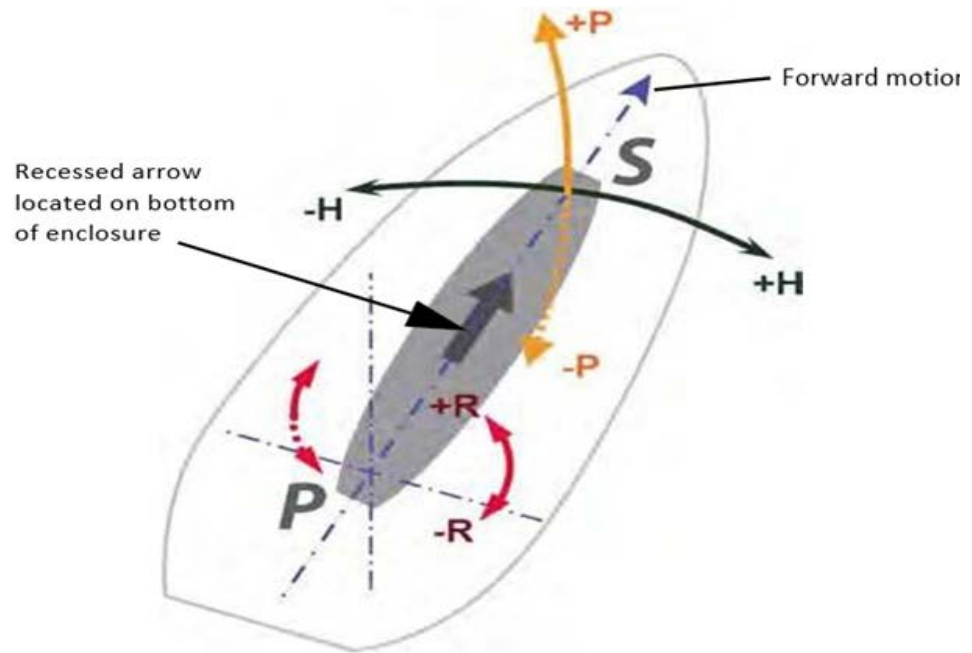

Figure 2-4: Recommended orientation and resulting signs of HPR values

Continued on next page

Mounting the V200s, Continued

Mounting
orientation
example,
continued

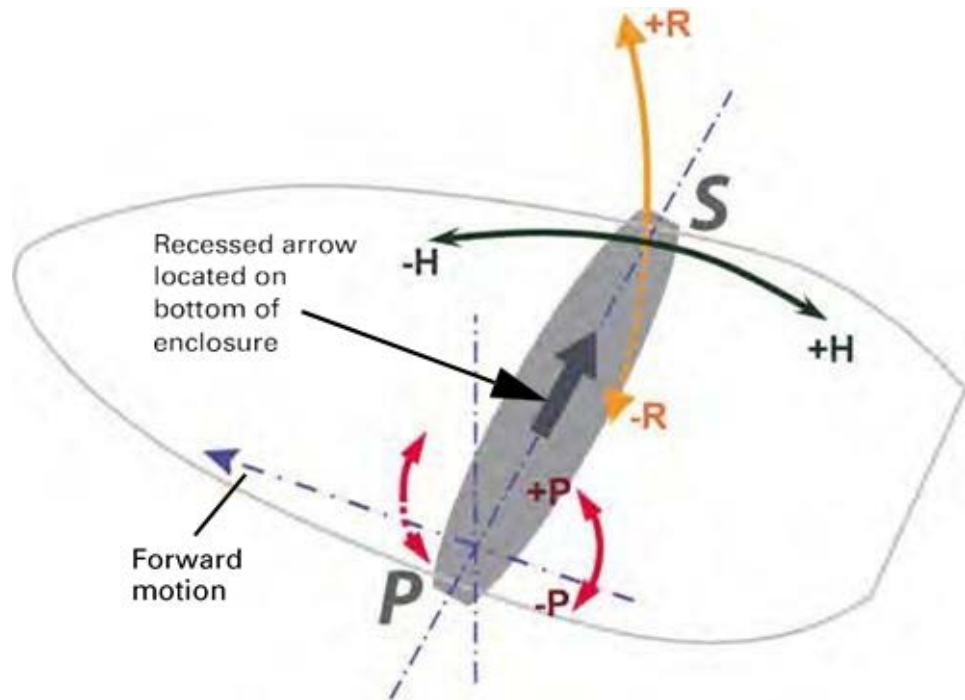

Figure 2-5: Alternate orientation and resulting signs of HPR values

Continued on next page

Mounting the V200s, Continued

V200s
dimensions

Figure 2-6 illustrates the physical dimensions of the V200s GNSS Compass.

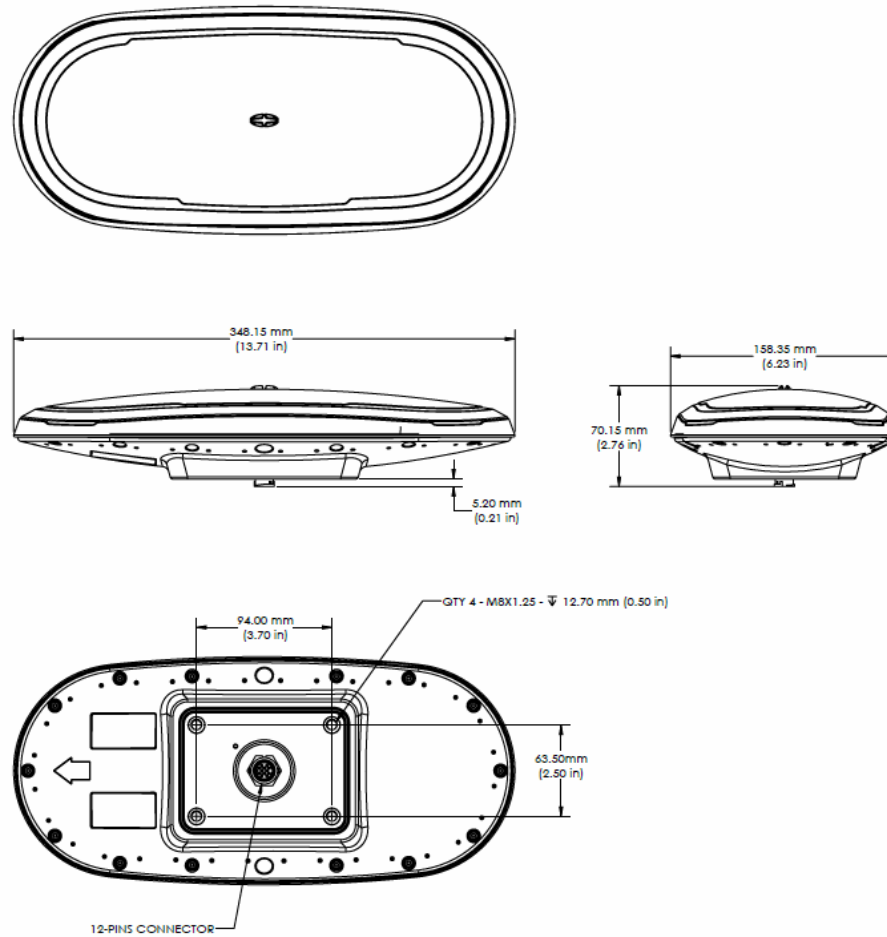

Figure 2-6: V200s dimensions

Continued on next page

Mounting the V200s, Continued

Mounting alignment, continued

If you have another accurate source of heading data on your vessel, such as a gyrocompass, you may use its data to correct for a bias in V200s alignment within the V200s software configuration.

Alternatively, you can physically adjust the heading of the V200s so that it renders the correct heading measurement or add a software offset.

Power/data cable considerations

Before mounting the V200s, consider the following regarding power/data cable routing:

Do	Do not
Ensure cable reaches appropriate power source	Run cables in areas of excessive heat
Keep cable away from corrosive chemicals	Run cables through a door or window jams
Connect to a data storage device, computer, or other device that accepts GNSS data	Crimp or excessively bend the cable
Keep cable away from rotating machinery	Place tension on the cable
Remove unwanted slack from the cable at the V200s end	
Secure along the cable route using plastic wrapping	

⚠ WARNING:

Improperly installed cable near machinery can be dangerous.

Continued on next page

Mounting the V200s, Continued

Power/data cable considerations, continued

The following table lists the steps to connect the power/data cable to your V200s.

Table 2-1: Connect Power/Data Cable

Step	Action
1	Align the cable connector key-way with the V200s connector key.
2	Rotate the cable ring clockwise until it locks. The locking action is firm; you will feel a positive “click” when it has locked.

Mounting options

The V200s offers four different mounting options:

- Bottom-up Surface Mounting for straight cable
- Top-down Surface Mounting for straight cable
- Top-down Surface Mounting for right-angle cable
- Pole Mounting

Note: Hemisphere GNSS does not supply mounting surface hardware or a mounting pole. You must supply the appropriate mounting hardware required to complete V200s installation.

Surface-mounting the V200s

Surface-mounting the V200s

Be mindful of the following when planning your installation:

- If you need the GNSS-assisted roll measurement, install the V200s perpendicular to the vessel’s axis. If you do not need this measurement, install the V200s parallel with the vessel’s axis.
- Hemisphere GNSS does not supply mounting surface hardware or a mounting pole. You must supply the appropriate hardware or mounting pole required to complete V200s installation.
- You can enter a software offset to accommodate for a heading measurement bias due to installation.
- The flat surface may be fabricated per your installation, an off-the-shelf item (such as a radar mounting plate), or an existing surface on your vessel.

Surface-mounting the V200s from the bottom up for straight cable

Complete the following steps to Surface-mount the V200s from the bottom up.

Table 2-2: Bottom-up, Surface-mounting the V200s

Step	Action
1	Determine the desired location and proper orientation for the V200s. See “ Mounting Orientation ” for information on determining the desired orientation.
2	Navigate to the HGNS website Home / Products / Smart Antennas / Vector V200 GNSS Smart Antenna or to HGNS website Home / Resources & Support / Technical Documentation / Drawings & Schematics
3	Use the supplied V200 Mounting Template drawing or photocopy the bottom of the V200s to plan the mounting hole locations. If using a photocopy, make sure it is scaled one-to-one with the mounting holes on the bottom of the V200s.
4	If required, use a center punch to mark the hole centers on the mounting surface, then drill the mounting holes with a 9mm (.35 in) bit appropriate for the surface.

Continued on next page

Surface-mounting the V200s, Continued

Surface-mounting the V200s, continued

Table 2-2: Bottom-up, Surface-mounting the V200s (continued)

Step	Action
5	Place the V200s over the mounting holes and insert the mounting screws through the bottom of the mounting surface into the V200s.
6	Tighten to a torque of 8 - 10 lbs-ft. The maximum thread depth engagement must be no more than 0.50 in!
	<div style="display: flex; align-items: center;"> <div style="border: 1px solid red; padding: 2px; margin-right: 10px;"> ⚠ WARNING: </div> <div> Damage resulting from over-tightening is not covered by the warranty. </div> </div>

Surface-mounting the V200s from the top down for straight cable and for right-angle cable

Complete the following steps to surface-mount the V200s from the top down.

Table 2-3: Top down, Surface-mounting the V200s





Step	Action
1	<p>Secure the Surface Mount Adapter (676-0043-10) to the V200s using the supplied mounting hardware. Tighten to a torque of 8 - 10 lbs-ft. The maximum thread depth engagement must be no more than 0.50 in!</p> <div style="text-align: center;"> <p>Figure 2-7: Surface Mount Adapter (676-0043-10)</p> <p>Figure 2-8: Surface Mount Adapter secured to V200s</p> </div>
2	Determine the desired location and proper orientation for the V200s. See " Mounting Orientation " for information on determining the desired orientation.

Continued on next page

Surface-mounting the V200s, Continued

Surface-mounting the V200s from the top down for straight cable and for right-angle cable, continued

Table 2-3: Top down, Surface-mounting the V200s (continued)

Step	Action	
3	Select the applicable surface mount:	
	Select this surface mount if you will thread the cable straight down.	Select this surface mount if you will thread the cable towards the back of the unit.
		
<p align="center">Figure 2-9: V200 Low-Profile Surface Mount (676-0041-10)</p>	<p align="center">Figure 2-10: V200 Right-Angle Surface Mount (676-0042-10)</p>	
4	Place the surface mount in the desired location on the installation surface.	
5	If required, use a center punch to mark the hole centers, then drill the mounting holes with bit appropriate for the surface.	
	<p>Note: The diameter of the 676-0041-10 mounting holes is 6.4 mm (.25 in)</p>	<p>Note: The diameter of the 676-0042-10 mounting holes is 9 mm (.35 in)</p>
		
<p align="center">Figure 2-11: 676-0041-10 Mounting Holes</p>	<p align="center">Figure 2-12: 676-0042-10 Mounting Holes</p>	
6	Secure the mount to the installation surface. Tighten to a maximum torque of 10 lbs-ft.	

Continued on next page

Surface-mounting the V200s, Continued

Surface-mounting the V200s from the top down for straight cable and for right-angle cable, continued

Table 2-3: Top down, Surface-mounting the V200s (continued)



Step	Action
7	Thread the cable into through the surface mount, then connect the cable to the unit.
8	Carefully secure the mount to the V200s by placing it into the surface mount until the four latches snap into place, first on one side, and then the other.
	Straight
	Right-Angle
	
Figure 2-13: Adapters with both sides secured	
Note: To remove the V200s, simply reverse the process by pushing in the clips on one side, at which point the V200s can easily be removed.	

Pole-mounting the V200s

Pole-mounting the V200s

Complete the following steps to pole-mount the V200s:

Table 2-4: Pole-mounting the V200s

Step	Action		
1	Determine the desired location and proper orientation for the V200s. See " Mounting Orientation " for information on determining the desired orientation.		
2	Thread the jam nut onto the 1-inch pole, then thread the pole mount. <div data-bbox="778 667 1166 949" style="text-align: center;">  </div> <p data-bbox="608 954 1342 987">Figure 2-14: Pole mount with jam nut loosely threaded</p> <div data-bbox="576 1025 1382 1108" style="border: 1px solid black; padding: 5px;"> <table border="0"> <tr> <td data-bbox="576 1025 794 1108" style="background-color: #f0f0f0; padding: 2px;">⚠ WARNING:</td> <td data-bbox="794 1025 1382 1108">Do not tighten the pole mount to more than 4 lbs-ft.</td> </tr> </table> </div>	⚠ WARNING:	Do not tighten the pole mount to more than 4 lbs-ft.
⚠ WARNING:	Do not tighten the pole mount to more than 4 lbs-ft.		
3	Thread the cable either through the hollow pole or through the opening in the pole mount.		
4	Connect the cable to the V200s, then secure the pole mount to the V200s using the supplied mounting hardware. Tighten to a torque of 8 - 10 lbs-ft. The maximum thread depth engagement must be no more than 0.50 in! <div data-bbox="778 1346 1166 1637" style="text-align: center;">  </div> <p data-bbox="695 1641 1254 1675">Figure 2-15: Pole mount secured to V200s</p>		

Continued on next page

Pole-mounting the V200s, Continued

Pole-mounting the V200s, continued

Table 2-4: Pole-mounting the V200s (continued)

Step	Action
5	<p>Verify the orientation of the unit, then tighten the jam nut to the bottom of the pole mount to a torque of 8 – 10 lbs-ft.</p>  <p>Figure 2-16: Pole mount with jam nut tightly threaded to secure V200s orientation</p>

Chapter 3: Connecting the V200s

Introduction

This chapter provides instructions on how to connect your V200s receiver.

Contents

Topic	See Page
Ports	37
Selecting Baud Rates and Message Types	38
Connecting the V200s to External Devices	39

Ports

Overview

The V200s offers RS-232 and RS-422 communication.

Serial ports

The V200s supports:

- two independent full-duplex RS-232 (Ports A and B) and one RS-422 Tx (Port C); or
- one full-duplex RS-422 (Port A) and one RS-422 Tx (Port C)

The V200s automatically detects and switches to the appropriate serial protocol on Ports A and B.

Note: The V200s has maximum baud rate of 115200.

Serial port configuration

You may configure the GNSS receiver to output any combination of data.

Note: For successful communications, use the 8-N-1 protocol and set the baud rate of the V200s's serial ports to match that of the devices to which they are connected. Flow control is not supported.

Selecting Baud Rates and Message Types

Baud rates & Message types

When selecting your baud rate and message types, use the following formula to calculate the bits/sec for each message and sum the results to determine the baud rate for your required data throughput.

Message output rate * Message length (bytes) * bits in byte =
Bits/second

(1 character = 1 byte, 8 bits = 1 byte, use 10 bits/byte to account for overhead).

For information on message output rates refer to the [Hemisphere GNSS Technical Reference Manual](#).

Connecting the V200s to External Devices

Recommend-
ations for
connecting to
other devices

When interfacing with other serial devices, ensure the transmit data output and the signal grounds from the V200s are connected to the data input of the other device. The signal grounds must also be connected.

For a list of Hemisphere GNSS commands, please refer to the [Hemisphere GNSS Technical Reference Manual](#).

Power/data
cable
considerations

The V200s automatically detects and switches to the correct serial protocol on Ports A and B.

Continued on next page

Connecting the V200s to External Devices, Continued

Power/data
cable pin-out
specifications

The V200s uses a 12-pin connector and supports RS-232 and RS-422. The V200s can auto-detect and auto-switch between RS-232 and RS-422.

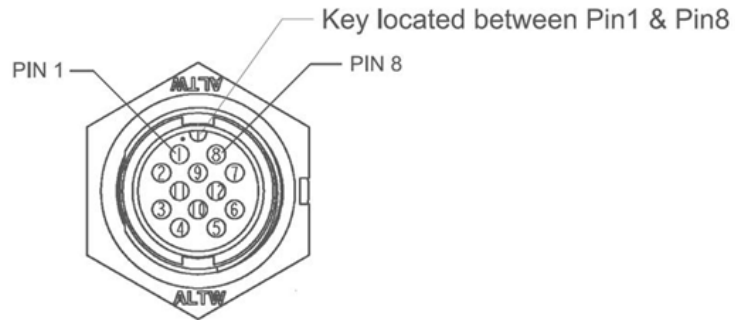

Figure 3-1: V200s pin-out assignments

Table 3-1 shows the cable pin-out specifications.

Table 3-1: V200s Pin-outs (Device Out)

PIN NUMBER	COLOR	SIGNAL
1	White	RS232 Tx B/RS422 Tx A+
2	Green	RS232 Rx B/RS422 Rx A-
3	Violet	1PPS
4	Grey	Alarm
5	Red	Power In
6	White / Black	RS422 TX C+
7	Yellow	Digital Ground
8	Brown	RS232 Rx A /RS422 Rx A+
9	Blue	RS232 Tx A / RS422 Tx A-
10	Black	Power Ground
11	Drain	Drain
12	White / Brown	RS422 Tx C-

Chapter 4: Understanding the V200s

Overview

Introduction

The GNSS receiver begins tracking satellites when it powers up and is placed outside in an open area. Position and heading accuracy vary depending upon location and environment. Position performance can be improved with RTK or DGNSS.

The following sections provide the steps to configure your V200s to use Atlas, SBAS, or RTK.

Note: Differential source and RTK status impact only positioning and heave. There is no impact to heading, pitch, or roll.

Contents

Topic	See Page
GNSS Overview	42
Differential Operation	43
SBAS Tracking	43
Atlas L-band	43
Supplemental Sensors	44

GNSS Overview

GNSS operation The GNSS receiver is always operating, regardless of the DGNSS mode of operation. The following sections describe the general operation of the V200s's internal GNSS receiver.

Note: Differential source and status have no impact on heading, pitch, or roll. They only have an impact on positioning and heave.

The V200s provides accurate and reliable heading and position information at high update rates. To accomplish this task, the V200s uses a high performance GNSS receiver and two antennas for GNSS signal processing.

One antenna is designated as the primary GNSS antenna and the other is the secondary GNSS antenna. Positions computed by the V200s are referenced to the phase center of the primary GNSS antenna. Heading data references the Vector formed from the primary GNSS antenna phase center to the secondary GNSS antenna phase center.

The heading arrow located on the bottom of the V200s enclosure defines system orientation. The arrow points in the direction the heading measurement is computed (when the antenna is installed parallel to the fore-aft line of the vessel). The secondary antenna is directly above the arrow.

Differential Operation

Differential (DGNSS) operation

The V200s delivers positioning accuracies of 2.5 m 95% and provides positioning quality to better than 0.6 m 95% using differential corrections received through the internal SBAS demodulator or through Atlas L-band.

SBAS Tracking

SBAS tracking

The V200s features two-channel tracking that provides an enhanced ability to maintain a lock on an SBAS satellite when more than one satellite is in view. This redundant tracking approach results in more consistent tracking of an SBAS signal in areas where signal blockage of a satellite is possible.

Atlas L-band

Atlas L-band

Atlas L-band corrections are available worldwide. With Atlas, the positioning accuracy does not degrade as a function of distance to a base station, as the data content is not composed of a single base station's information, but an entire network's information.

The V200s can calculate a position with 30 cm RMS (horizontal) accuracy.

To configure the receiver to use Atlas L-band, a subscription must be purchased.

Supplemental Sensors

Overview

The V200s has a supplemental sensor integrated into the H220 GNSS board that is enabled by default. You can enable/disable the sensor.

The sensor acts to reduce the RTK search volume, which improves heading startup and reacquisition times. This improves the reliability and accuracy of selecting the correct heading solution by eliminating other possible, erroneous solutions.

The [Hemisphere GNSS Technical Reference Manual](#) describes the commands and methodology required to recalibrate, query, or change the sensor status.

Tilt aiding

The V200s' s internal sensor is factory calibrated and enabled by default and constrains the RTK heading solution beyond the volume associated with a fixed antenna separation.

The V200s knows the approximate inclination of the secondary antenna with respect to the primary antenna. The search space defined by the sensor is reduced to a horizontal ring on the sphere's surface by reducing the search volume and decreases startup and reacquisition times (see Figure 4-1).

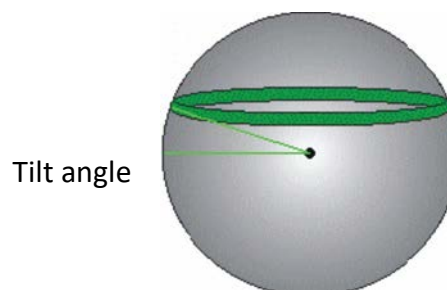

Figure 4-1: V200s tilt aiding

Continued on next page

Supplemental Sensors, Continued

Gyro aiding

The V200s's internal sensor reduces reacquisition times when a GNSS heading is lost due to blocked satellite signals.

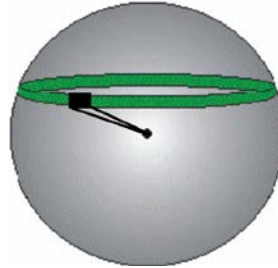

Figure 4-2: V200s gyro aiding

The gyro aiding accurately smooths the heading output and the ROT. The sensor also provides an alternate source of heading, accurate to within 1° per minute for up to three minutes in times of GNSS loss for either antenna. If the outage lasts longer than three minutes, the sensor will have drifted too far and the V200s begins outputting null fields in the heading output messages. There is no user control over the timeout period of the sensor.

The sensor initializes itself at power up and during initialization, or you can calibrate it as outlined in the [Hemisphere GNSS Technical Reference Manual](#).

For optimal performance, when the sensor is first initializing, the dynamics the sensor experiences during this warm-up period are similar to the regular operating dynamics.

Gyro-aiding updates the post HTAU-smoothed heading. As a result, if the HTAU value is increased while gyro aiding is enabled, there will be little to no lag in heading output due to vessel maneuvers.

The [Hemisphere GNSS Technical Reference Manual](#) includes information on setting an appropriate HTAU value for the application.

Time Constants

Overview

The V200s incorporates user-configurable time constants that can provide a degree of smoothing to the heading, pitch, Rate-of-Turn (ROT), Course-over-Ground (COG), and speed measurements.

You can adjust these parameters depending on the expected dynamics of the vessel. For example, increasing the time is reasonable if the vessel is very large and is not able to turn quickly or would not pitch quickly. The resulting values would have reduced “noise,” resulting in consistent values with time.

If the vessel is quick and nimble, increasing this value can create a lag in measurements.

If you are unsure on how to set this value, it is best to be conservative and leave it at the default setting.

Note: For heading and rate of turn there is no lag once the sensor is calibrated and enabled.

Formulas for determining the level of smoothing are located in the [Hemisphere GNSS Technical Reference Manual](#). If you are unsure how to set this value, it is best to be conservative and leave the default setting.

Heading

Use the \$JATT,HTAU command to adjust the level of responsiveness of the true heading measurement provided in the \$GPHDT message. The default value of this constant is 0.2 seconds of smoothing when gyro-aid is enabled.

By disabling gyro-aid, the equivalent default value of the heading time constant should be 0.5 seconds of smoothing. This is not automatic, and therefore it must be manually entered.

Note: Increasing the time constant increases the level of heading smoothing and increases lag (with gyro-aid disabled).

Continued on next page

Time Constants, Continued

Pitch

Use the \$JATT,PTAU command to adjust the level of responsiveness of the pitch measurement provided in the \$PSAT,HPR message. The default value of this constant is 0.5 seconds of smoothing.

Note: Increasing the time constant increases the level of pitch smoothing and increases lag.

Rate-of-Turn (ROT)

Use the \$JATT,HRTAU command to adjust the level of responsiveness of the ROT measurement provided in the \$GPROT message. The default value of this constant is 2.0 seconds of smoothing.

Note: Increasing the time constant increases the level of ROT smoothing.

Course-Over-Ground (COG)

Use the \$JATT,COGTAU command to adjust the level of responsiveness of the COG measurement provided in the \$GPVTG message. The default value of this constant is 0.0 seconds of smoothing.

Note: Increasing the time constant increases the level of COG smoothing.

COG is computed using only the primary GNSS antenna and its accuracy depends upon the speed of the vessel (noise is proportional to 1/speed).

This value is invalid when the vessel is stationary, as tiny movements due to calculation inaccuracies are not representative of a vessel's movement.

Speed

Use the \$JATT,SPDTAU command to adjust the level of responsiveness of the speed measurement provided in the \$GPVTG message. The default value of this parameter is 0.0 seconds of smoothing.

Note: Increasing the time constant increases the level of speed measurement smoothing.

Chapter 5: Operating the V200s

Overview

Introduction

This chapter provides information on how to power and operate your V200s receiver.

Contents

Topic	See Page
Powering the V200s	49

Powering the V200s

Power connections

For best performance, use a clean and continuous power supply. See Table B-3 for complete power specifications.

If using an unterminated cable, before powering up the V200s, you must terminate the wires of the power cable as required. There are a variety of power connectors and terminals on the market from which to choose, depending on your specific requirements. Refer to Figure 2-9 and Table 2-4 for pinout specifications.

⚠ WARNING:
Do not apply a voltage higher than 36 VDC. The V200s is protected from a reversed power connection. A 3-Amp power fuse is recommended for the protection of personnel and the system.

The V200s starts when sufficient voltage is applied to the power leads of the extension cable.

Electrical isolation

The V200s's power supply is isolated from the communication lines and the PC-ABS plastic enclosure isolates the electronics mechanically from the vessel (addressing the issue of vessel hull electrolysis).

Appendix A: Troubleshooting

Overview

Introduction

Appendix A provides troubleshooting for common problems.

Contents

Topic	See Page
Troubleshooting	51

Troubleshooting

 Appendix A
troubleshooting

Symptom	Possible Solution
Receiver fails to power	<ul style="list-style-type: none"> • Verify polarity of power leads • Check integrity of power cable connectors • Check power input voltage (9 to 36 VDC) • Check the voltage coming out of the connector at the end of the cable • Check current restrictions imposed by power source (minimum available should be > 1.0 A)
No data from V200s	<ul style="list-style-type: none"> • Check receiver power status to ensure the receiver is powered • Verify desired messages are activated (using PocketMax or \$JSHOW command in any terminal program) • Ensure the baud rate of the V200s matches that of the receiving device • Check integrity and connectivity of power and data cable connections
Random data from V200s	<ul style="list-style-type: none"> • Verify the RTCM or binary messages are not output accidentally (send a \$JSHOW command) • Ensure the baud rate of the V200s matches that of the remote device • The volume of data requested for output by the V200s could be higher than the current baud rate supports.
No GNSS lock	<ul style="list-style-type: none"> • Verify the V200s has a clear view of the sky • Use PocketMax to check how many satellites are in view and the SNR values

Continued on next page

Troubleshooting, Continued

Appendix A troubleshooting, continued

Symptom	Possible Solution
No SBAS lock	<ul style="list-style-type: none">• Verify the V200s has a clear view of the sky• Set SBAS mode to automatic with the \$JWAASPRN,AUTO command <p>Note: SBAS lock is only possible if you are in an appropriate SBAS region; currently, there is limited SBAS availability in the southern hemisphere.</p>
No Atlas	<ul style="list-style-type: none">• First, check to see for an Atlas Basic subscription by sending \$JK,SHOW to see which commands are listed. Or, connect to PocketMax, go to the About tab, and check the listed activations• Ensure you are tracking the correct Atlas satellite, or set the receiver to 'Auto-Tune' by sending \$JFREQ,AUTO

Continued on next page

Troubleshooting, Continued

Appendix A troubleshooting, continued

Symptom	Possible Solution
No heading or incorrect heading value	<ul style="list-style-type: none"> • Check CSEP value is constant without varying more than 1 cm (0.39 in)—larger variations may indicate a high multipath environment and require moving the receiver location • Heading is from primary GNSS antenna to secondary GNSS antenna, so the arrow on the underside of the V200s is directed to the bow side • \$JATT,SEARCH command forces the V200s to acquire a new heading solution (unless gyro is enabled) • Enable GYROAID to provide heading for up to three minutes during GNSS signal loss • Enable TILTAID to reduce heading search times • Monitor the number of satellites and SNR values for both antennas within PocketMax—at least four satellites should have strong SNR values • The volume of data requested for output by the V200s could be higher than the current baud rate supports.
No DGPS position in external RTCM mode	<ul style="list-style-type: none"> • Verify the baud rate of the RTCM input port matches the baud rate of the external source • Verify the pinout between the RTCM source and the RTCM input port (transmit from the source must go to receive of the RTCM input port and grounds must be connected)

Appendix B: Technical Specifications

Technical Specifications

Introduction

Appendix B provides the V200s technical specifications, and the V200s certification information.

Contents

Topic	See Page
V200s Technical Specifications	55

V200s Technical Specifications

V200s technical specifications

Table B-1: V200s sensor and positioning accuracy

Item	Specification
Receiver type	Vector sFreq GNSS Compass
Signals Received	GPS, GLONASS, BeiDou, Galileo, QZSS ¹ , and Atlas
Channels	422
GPS sensitivity	-142 dBm
SBAS tracking	2-channel, parallel tracking
Update rate (position and heading)	10 Hz standard, 20 Hz optional
Positioning accuracy (Standard)	2.0 m RMS (Autonomous, no SA) 0.50 m RMS (SBAS)
Positioning accuracy (Optional)	1.2 m RMS (Autonomous, no SA) ¹ 0.30 m RMS (SBAS) ² 0.30 m RMS (Atlas) optional ³
Heading accuracy (GNSS)	1.5° RMS ¹ 0.75° RMS optional ¹
Heave accuracy (GNSS)	30 cm ⁴
Pitch/Roll accuracy	1.5° RMS
Rate of turn	90°/s maximum
Cold start	60 s typical (no almanac or RTC)
Warm start	20 s typical (almanac and RTC)
Hot start	1 s typical (almanac, RTC, and position)
Heading fix	10 s typical (valid position)
Maximum speed	1,850 kph (999 kts)
Maximum altitude	18,288m (60,000 ft)
Compass safe distance	50 cm ⁵
Differential options	Atlas, SBAS

Continued on next page

V200s Technical Specifications, Continued

V200s technical specifications, continued

Table B-2: Communication

Item	Specification
Connector ports	12-pin
Ports	RS-232 or RS-422
Baud Rates	4800-115200
Correction I/O Protocol	RTCM SC-104
Data I/O Protocol	NMEA 0183, Hemisphere proprietary

Table B-3: Power

Item	Specification
Input voltage	6 to 36 VDC
Power consumption	TBD
Current consumption	TBD
Power isolation	Isolated to enclosure
Reverse polarity protection	Yes

Continued on next page

V200s Technical Specifications, Continued

V200s technical specifications, continued **Table B-4: Mechanical**

Item	Specification
Dimensions No Mount: Pole Mount:	34.8 L x 15.8 W x 6.5 H (cm) 34.8 L x 15.8 W x 14.3 H (cm)
Weight (no mount)	0.75 kg
Power/data connector	12-pin
Aiding Devices Gyro:	Provides smooth heading, fast heading reacquisition and reliable 1° per minute heading for periods up to 3 minutes when loss of GPS has occurred ²
Tilt Sensor:	Provides pitch and roll data and assist in fast start-up and reacquisition of heading solution

Table B-5: Environmental

Item	Specification
Operating temperature	-40°C to + 70°C (-22°F to + 158°F)
Storage temperature	-40°C to + 85°C (-40°F to + 185°F)
Humidity	95% non-condensing
Enclosure	ISO 60529:2013 for IPx6/IPx7/IPx9
Vibration	IEC 60945:2002 Section 8.7 Vibration
EMC	IEC60945:2002 EN 301 489-1 V2.1.1 EN 301 489-5 V2.1.1 EN 301 489-19 V2.1.0 EN 303 413 V1.1.1

Continued on next page

V200s Technical Specifications, Continued

V200s technical specifications, continued

Table B-6: Certifications

Certification
RCM (Australia)

- 1 Depends on multipath environment, number of satellites in view, satellite geometry, no SA, and ionospheric activity
- 2 Depends on multipath environment, number of satellites in view, SBAS coverage and satellite geometry
- 3 Depends on multipath environment, number of satellites in view, and satellite geometry
- 4 Based on a 40 second time constant
- 5 This is the minimum safe distance measured when the product is placed in the vicinity of the steering magnetic compass. The ISO 694 defines “vicinity” relative to the compass as within 5 m (16.4 ft) separation

Appendix C: Commands and Messages

Overview

Introduction

Appendix C contains the common commands and messages used by the V200s. Reference the following tables for sending and receiving commands and messages.

For information on message output rates refer to the [Hemisphere GNSS Technical Reference Manual](#).

Example message	Rate	Bytes	Bits in byte	Bits/sec
GPHDT	10	20	10	2000
GPROT	5	18	10	900
GPHDG	1	33	10	330
GPGGA	1	83	10	830
GPZDA	1	38	10	380
			Total	4440

Contents

Topic	See Page
Serial Commands	60
NMEA 0183 Messages	63
Binary Messages	67

Serial Commands

Serial commands

The V200s has a maximum baud rate of 115200.

Note: When selecting baud rate and message types, use the following formula and example to calculate the bits/sec for each message and then sum the results to determine the baud rate for your required data throughput.

Message length (bytes) * bits in byte = Bits/second
 (1 character = 1 byte, 8 bits = 1 byte, use 10 bits/byte to account for overhead)

Table C-1: Serial commands

Command	Description
\$JAGE	Specify maximum DGPS (COAST) correction age (6 to 8100 seconds)
\$JAPP	Query or specify receiver application firmware
\$JASC	Specify ASCII messages to output to specific ports
\$JATT, COGTAU	Set/query COG time constant (0.0 to 3600.0 sec)
\$JATT, CSEP	Query antenna separation
\$JATT, EXACT	Enable/disable internal filter reliance on the entered antenna separation
\$JATT, GYROAID	Enable/disable gyro
\$JATT, HBIAS	Set/query heading bias (-180.0° to 180.0°)
\$JATT, HELP	Show the available commands for GNSS heading operation and status
\$JATT, HIGHMP	Set/query the high multipath setting for use in poor GNSS environments
\$JATT, HRTAU	Set/query ROT time constant (0.0 to 3600.0 sec)
\$JATT, HTAU	Set/query heading time constant (0.0 to 3600.0 sec)
\$JATT, LEVEL	Enable/disable level operation
\$JATT, NMEAHE	Change the HDG, HDM, HDT, and ROT message headers between GP and HE
\$JATT, PBIAS	Set/query pitch/roll bias (-15.0° to 15.0°)

Continued on next page

Serial Commands, Continued

Serial commands, continued

Table C-1: Serial commands (continued)

Command	Description
\$JATT, PTAU	Set/query pitch time constant (0.0 to 3600.0 sec)
\$JATT, ROLL	Configure for roll or pitch GNSS orientation
\$JATT, SEARCH	Force a new GNSS heading search
\$JATT, SPDTAU	Set/query speed time constant (0.0 to 3600.0 sec)
\$JATT, SUMMARY	Display a summary of the current Crescent Vector settings
\$JATT, TILTAID	Enable/disable accelerometer, pre-calibrated
\$JATT, TILTCAL	Calibrate accelerometers
\$JBAUD	Specify RS-232, RS-422 (output) communication rate
\$JBIN	Specify binary messages to output to specific ports
\$JDIFF	Query or specify differential correction mode
\$JGEO	Query or specify SBAS for current location and SBAS satellites
\$JI	Query unit's serial number and firmware versions
\$JOFF	Turn off all data messages
\$JQUERY,GUIDE	Query accuracy suitability for navigation
\$JMODE,GPSONLY,YES	GPS only mode

Continued on next page

Serial Commands, Continued

Serial
commands,
continued

Table C-1: Serial commands (continued)

Command	Description
\$JMODE,GPSONLY,N O	Multi-GNSS mode
\$JRESET	<p>Reset unit's configuration to firmware defaults</p> <div style="border: 1px solid black; padding: 5px;"><p>Note: \$JRESET clears all parameters. For the V200s you will have to issue the \$JATT, FLIPBRD,YES command to properly redefine the circuitry orientation inside the product once the receiver has reset. Failure to do so will cause radical heading behavior.</p></div> <p>You can also issue the \$JRESET command with an optional field as follows:</p> <ul style="list-style-type: none">• \$JRESET,ALL does everything \$JRESET does, plus it clears almanacs• \$JRESET,BOOT does everything \$JRESET,ALL does, plus clears use of the real-time clock at startup, clears use of backed-up ephemeris and almanacs, and reboots the receiver when done
\$JSAVE	Save session's configuration changes

NMEA 0183 Messages

V200s

 NMEA 0183 and
other messages

Table C-2: NMEA 0183 and other messages

In Table C-2 the Info Type value is one of the following:

- P = Position
- V = Velocity, Time
- H = Heading, Attitude S = Sets, Stats, Quality

Message	Info Type	Max Output Rate	Description	IEC Approved Message
\$GPDTM	P	1 Hz	Datum reference	Yes
\$GPGGA	P	50 Hz	GPS position and fix data	Yes
\$GPGLL	P	50 Hz	Geographic position - lit/long	Yes
\$GPGNS	P	50 Hz	GNSS position and fix data	Yes
\$GPGRS	S	1 Hz	GNSS range residual (RAIM)	Yes
\$GPGSA	S	1 Hz	GNSS DOP and active satellites	Yes
\$GPGST	S	1 Hz	GNSS pseudo range error statistics and position accuracy	Yes
\$GPGSV	S	1 Hz	GNSS satellites in view	Yes
*\$GPHDG	H	50 Hz	Provides magnetic deviation and variation for calculating magnetic or true heading	Yes

Continued on next page

NMEA 0183 Messages, Continued

V200s
NMEA 0183
and other
messages,
continued

Table C-2: NMEA 0183 and other messages (continued)

Message	Info Type	Max Output Rate	Description	IEC Approved Message
*\$GPHDM	H	50 Hz	Magnetic heading (based on GNSS-derived heading and magnetic declination)	No
*\$GPHDT	H	50 Hz	GNSS-derived true heading	Yes
\$GPHEV	H	50 Hz	Heave value (in meters)	Yes
\$GPRMC	P	50 Hz	Recommended minimum specific GNSS data	Yes
*\$GPROT	H	50 Hz	GNSS-derived rate of turn (ROT)	Yes
\$GPRRE	S	1 Hz	Range residual and estimated position error	Yes
\$GPVTG	V	50 Hz	COG and ground speed	Yes
\$GPZDA	V	50 Hz	Time and date	Yes
\$HEACK	S	1 Hz	Acknowledge alarm	Yes
\$HEACN	S	1 Hz	Alert command	Yes
\$HEALF	S	1 Hz	Alert sentence	Yes
\$HEALC	S	1 Hz	Cyclic alert list	Yes
\$HEALR	S	1 Hz	Set alarm state	Yes
\$HEHBT	S	1 Hz	Heartbeat supervision sentence	Yes

Continued on next page

NMEA 0183 Messages, Continued

V200s
NMEA 0183
and other
messages,
continued

Table C-2: NMEA 0183 and other messages (continued)

Message	Info Type	Max Output Rate	Description	IEC Approved Message
\$HETHS	H	50 Hz	True heading and status	Yes
\$PASHR	H	50 Hz	Time, heading, roll, and pitch data in one message	No
\$PSAT,GBS	S	1 Hz	Satellite fault detection (RAIM)	Yes
\$PSAT,HPR	H	50 Hz	Proprietary NMEA message that provides heading, pitch, roll, and time in single message	No
\$PSAT,INTLT	H	1 Hz	Proprietary NMEA message that provides the pitch and roll measurements from the internal inclinometers (in degrees)	Yes
\$RD1	S	1 Hz	SBAS diagnostic information	Yes
\$TSS1	H	50 Hz	Heading, pitch, roll, and heave message in the commonly used TSS1 message format	No

Continued on next page

NMEA 0183 Messages, Continued

Notes:

- The GP of the message is the talker ID
- You can change the message header for the HDG, HDM, HDT, and ROT messages to either GP or HE uses the \$JATT,NMEAHE command
 - To preface these messages with GP, issue the following command:
\$JATT,NMEAHE,0<CR><LF>
 - To preface these messages with HE, issue the following command:
\$JATT,NMEAHE,1<CR><LF>
- GPGRS, GPGSA, GPGST, and GPGSV support external integrity checking; synchronize with corresponding fix data (GPGGA or GPGNS)
- For information on outputting roll, pitch, and heave data in one message refer to the [Hemisphere GNSS Technical Reference Manual](#)
- HBT is sent every 30 seconds
- After 60 seconds, a heading loss warning is escalated to an alarm
- Silence timeout is 30 seconds
- THS message definition (from IEC61162-1 ed5): THS – True heading and status
- \$HETHS,x.x,a*hh<CR><LF>
- x.x Heading, degrees true
- a Mode indicator (This field should not be null): A = Autonomous, E = Estimated (dead reckoning), V = Data not valid (including standby)
- 50Hz output requires 50Hz-capable firmware plus 50Hz activation

For more information on the \$JATT,NMEAHE command refer to the [Hemisphere GNSS Technical Reference Manual](#).

Binary Messages

Binary messages

Table C-3 lists the Binary messages used by the V200s. To log raw binary data to convert to Rinex, turn on Bin 76 (GPS), Bin 66 (GLONASS), Bin 36 (BeiDou), **or** turn on Bin 16 (all constellations; required for Galileo).

Additionally, enable ephemeris messages: Bin 95 (GPS), Bin 65 (GLONASS), Bin 35 (BeiDou), and Bin 45 (Galileo).

Enable the time conversion messages: Bin 94 (GPS), Bin 34 (BeiDou), and Bin 44 (Galileo).

Table C-3: Binary messages

\$JBIN Message	Description
1	GNSS position
2	GPS DOPs
80	SBAS
93	SBAS ephemeris data
94	Ionosphere and UTC conversion parameters
95	Satellite ephemeris data
96	Code and carrier phase (not needed if using Bin 16, Bin 16 includes information for all constellations)
97	Processor statistics
98	Satellites and almanac
99	GPS diagnostics
16	All constellation code and phase observation data. Use Bin16 if you need Galileo code and carrier phase observation. Galileo does not have a separate message
34	BeiDou time conversion
35	BeiDou ephemeris information

Main contact:

ProNav Norge AS / JRC Nord Europa
Hovlandsveien 52
4374 Egersund – Rogaland
Norway
e-mail: service@pronav.no Tlf: 51 46 43 00

Dokument revision:

Rev.1 – Internal revision version.