

SAILOR 7222 VHF DSC

User Manual



SAILOR 7222 VHF DSC

User manual

Document number: 98-171832-A

Release date: July 2, 2021

Disclaimer

Any responsibility or liability for loss or damage in connection with the use of this product and the accompanying documentation is disclaimed by Thrane & Thrane A/S. The information in this manual is provided for information purposes only, is subject to change without notice and may contain errors or inaccuracies. Manuals issued by Thrane & Thrane A/S are periodically revised and updated. Anyone relying on this information should acquire the most current version e.g. from www.cobhamsatcom.com, **Cobham SYNC Partner Portal**, or from the distributor. Thrane & Thrane A/S is not responsible for the content or accuracy of any translations or reproductions, in whole or in part, of this manual from any other source. In the event of any discrepancies, the English version shall be the governing text.

Thrane & Thrane A/S is trading as Cobham SATCOM.

Manufacturer

Thrane & Thrane A/S, Lundtoftegårdsvej 93D, 2800 Kgs. Lyngby, Denmark
Industrivej 30, 9490 Pandrup, Danmark

Copyright

© 2021 Thrane & Thrane A/S. All rights reserved.

Trademark Acknowledgments

- **SAILOR** is a registered trademark of Thrane & Thrane A/S.
- Other product and company names mentioned in this manual may be trademarks or trade names of their respective owners.

GPL notification

The software included in this product contains copyrighted software that is licensed under the GPL/LGPL. The verbatim licenses can be found online at:

<http://www.gnu.org/licenses/old-licenses/gpl-2.0.html>

<http://www.gnu.org/licenses/old-licenses/lgpl-2.1.html>

For the parts of the software that fall under the GPL/LGPL licenses, you may obtain the complete corresponding source code from us for a period of three years after our last shipment of this product, which will be no earlier than December 31, 2027, by sending a money order or check for DKK 50 to:

SW Technology/GPL Compliance,
Cobham SATCOM (Thrane & Thrane A/S),
Lundtoftegaardsvej 93D
2800 Lyngby
DENMARK

Write "source for product SAILOR 7222 VHF DSC" in the memo line of your payment. This offer is valid to anyone in receipt of this information.

<https://www.cobhamsatcom.com/legal/free-and-open-source-software-foss/>

Safety warning

The following general safety precautions must be observed during all phases of operation, service and repair of this equipment. Failure to comply with these precautions or with specific warnings elsewhere in this manual violates safety standards of design, manufacture and intended use of the equipment. Thrane & Thrane A/S assumes no liability for the customer's failure to comply with these requirements.

Ground the equipment

To minimize shock hazard, the SAILOR 7224 Control Unit unit and the SAILOR 7226 VHF Transceiver Unit must be connected to an electrical ground and the cable instructions must be followed.

RF exposure hazards and instructions

Your Cobham SATCOM radio set generates electromagnetic RF (radio frequency) energy when transmitting. To ensure that you and those around you are not exposed to excessive amounts of energy and thus to avoid health hazards from excessive exposure to RF energy, all persons must be at least 200 cm away from the antenna when the radio is transmitting.

Warranty limitation

IMPORTANT - The radio is not a user maintainable unit, and under no circumstances should the unit be opened except by authorized personnel. Unauthorized opening of the unit will invalidate the warranty.

Installation and service

Installation and general service must be done by skilled service personnel.

Compass safe distance

SAILOR 7226 VHF Transceiver Unit: Min. compass safe distance: 0.55 m

SAILOR 7224 Control Unit: Min. compass safe distance: 0.85 m

Alerte de sécurité

Dangers liés à l'exposition aux fréquences radio et instructions

Conformément à la réglementation d'Industrie Canada, le présent radio émetteur ne peut fonctionner qu'avec une antenne de type omnidirectionnelle, demi-onde ou d'un gain maximal de 4 dB, approuvée par Industrie Canada. Pour éviter les risques pour la santé dus à une exposition excessive aux champs de fréquences radio, une distance minimale de 200 cm est nécessaire entre l'utilisateur et le radio-émetteur.

Emergency calls

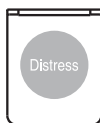

Lift Cover

Press **RED Button**

until beep sounds continuously
(more than 3 seconds)

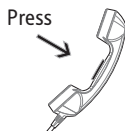

Use the **HANDSET** for voice calling

<p style="text-align: center;">MAYDAY-MAYDAY-MAYDAY</p> <p style="text-align: center;">This is</p> <p style="text-align: center;">NAME-NAME-NAME</p> <p style="text-align: center;">CALLSIGN or other IDENTIFICATION</p> <p style="text-align: center;">MMSI (If the initial alert is sent by DSC)</p>	<p style="text-align: center;">OWN ID</p> <p>SHIP's NAME: <input style="width: 100%;" type="text"/></p> <p>CALLSIGN: <input style="width: 100%;" type="text"/></p> <p>MMSI: <input style="width: 100%;" type="text"/></p>
--	--



MAYDAY

NAME of the **VESSEL** in distress
CALLSIGN or other **IDENTIFICATION**
MMSI
(If the initial alert is sent by DSC)

POSITION
given as **latitude** and **longitude**
or
If latitude and longitude are not known
or if time is insufficient,
in relation to a known geographical location

NATURE of distress
Kind of **ASSISTANCE** required
Any other useful **INFORMATION**

DISTRESS and COMMUNICATION FREQUENCIES

	DSC	Radiotelephony	NBDP
VHF	Channel 70	Channel 16	-----
MF	2187.5 kHz	2182.0 kHz	2174.5 kHz
HF4	4207.5 kHz	4125.0 kHz	4177.5 kHz
HF6	6312.0 kHz	6215.0 kHz	6268.0 kHz
HF8	8414.5 kHz	8291.0 kHz	8376.5 kHz
HF12	12577.0 kHz	12290.0 kHz	12520.0 kHz
HF16	16804.5 kHz	16420.0 kHz	16695.0 kHz

Remember to use the correct HF-procedures
Don't forget your EPIRB is the secondary means of alerting

99-132140

Cyber security

Cyber risk related to this VHF radio is related to the VHF radio itself.

Installation guidance

Installation must be IMO compliant.

The following mitigation is to be observed:

- Any PC or mobile device connected to the VHF radio must be screened and confirmed cyber-secure before connected to the VHF radio.
- The service interface must not be exposed directly to the Internet.
- If Internet access to the VHF radio is enabled through the service interface, this interface must be protected with a network security device such as a firewall.
- Do **not** use any connector on the VHF radio for charging mobile devices.

User guidance

The following mitigation is to be observed:

- Software updates and changes in the protected setup menu is only to be performed by Cobham-authorized personnel.
- The service interface must not be exposed directly to the Internet.
- If Internet access to the VHF radio is enabled, the interface must be protected with a network security device such as a firewall.
- Do **not** use any connector on the VHF radio for charging mobile devices.

Preface

Radio for occupational use

The SAILOR 7222 VHF DSC system obeys the requirements of SOLAS and is intended for use in maritime environment.

SAILOR 7222 VHF DSC system is designed for *occupational use only* and must be operated by licensed personnel only.

SAILOR 7222 VHF DSC system is not intended for use in an uncontrolled environment by general public.

SAILOR 7222 VHF DSC system is designed for installation by a skilled service person.

Training information

The SAILOR 7222 VHF DSC is designed for *occupational use only* and is also classified as such. It must be operated by licensed personnel only. It must only be used in the course of employment by individuals aware of both the hazards as well as the way to minimize those hazards.

The radio is thus NOT intended for use in an uncontrolled environment by general public. The SAILOR 7222 VHF DSC has been tested and complies with the FCC RF exposure limits for *Occupational Use Only*. The radio also complies with the following guidelines and standards regarding RF energy and electromagnetic energy levels including the recommended levels for human exposure:

- FCC OET Bulletin 65 Supplement C, evaluating compliance with FCC guidelines for human exposure to radio frequency electromagnetic fields.
- American National Standards Institute (C95.1) IEEE standard for safety levels with respect to human exposure to radio frequency electromagnetic fields, 3 kHz to 300 GHz
- American National Standards Institute (C95.3) IEEE recommended practice for the measurement of potentially hazardous electromagnetic fields - RF and microwaves.

Below the RF exposure hazards and instructions in safe operation of the radio within the FCC RF exposure limits established for it are described.

Warning, radiation

Your Cobham SATCOM radio set generates electromagnetic RF (radio frequency) energy when it is transmitting. To ensure that you and those around you are not exposed to excessive amounts of that energy (beyond FCC allowable limits for occupational use) and thus to avoid health hazards from excessive exposure to RF energy, FCC OET bulletin 65 establishes an Maximum Permissible Exposure (MPE) radius of 200 cm for the maximum power of your radio (25W selected) with a half wave omni-directional antenna having a maximum gain of 4 dB. This means all persons must be at least 200 cm away from the antenna when the radio is transmitting.

Installation considerations, radiation

1. An omni-directional antenna with a maximum power gain of 4 dB must be mounted at least 400 cm above the highest deck where people may be staying during radio transmissions. The distance is to be measured vertically from the lowest point of the antenna. This provides the minimum separation distance which is in compliance with RF exposure requirements and is based on the MPE radius of 200 cm plus the 200 cm height of an adult.
2. On vessels that cannot obey requirements in item 1, the antenna must be mounted so that its lowest point is at least 3 ft. (0.9 m) vertically above the heads of people on deck and all persons must be outside the 200 cm MPE radius during radio transmission.
 - Always mount the antenna at least 200 cm from possible human access.
 - Never touch the antenna when transmitting
 - Use only authorized Cobham SATCOM accessories.
3. If the antenna has to be placed in public areas or near people with no awareness of the radio transmission, the antenna must be placed at a distance not less than 200 cm from possible human access.

Failure to observe any of these warnings may cause you or other people to exceed FCC RF exposure limits or create other dangerous conditions.

Manual overview

This manual has the following chapters and appendices:

- *Introduction* contains a description of the VHF radio.
- *Operation* explains how to make and receive voice and DSC calls over VHF, including how to use and set up scanning, watch and replay.
- *Service & maintenance* contains support information including lists of accessories and a troubleshooting guide.
- Appendix with *Specifications* and *Maritime channels*.

Important

Not all installation information and instructions are covered in this manual. Please download the **SAILOR 7222 VHF DSC Installation manual** at

<https://sync.cobham.com>

In the installation manual you can read how to mount the VHF radio and how to connect accessories and external equipment, including detailed system configuration examples with cable specifications.

Related documents

Title and description	Document number
SAILOR 7224 Control Unit , Installation guide	98-173211
SAILOR 7226 VHF Transceiver Unit , Installation guide	98-164939
SAILOR 7222 VHF DSC , Installation manual (download only)	98-171833
SAILOR 6101 and SAILOR 6103 Alarm Panel , Installation and user manual	98-130981
Emergency call sheet	98-132369

Contents

Chapter 1 Introduction

VHF radio with DSC Class A	1
Accessories available	4
System configuration - example	7

Chapter 2 Operation

General use and navigation	10
VHF radio communication	17
Watch	20
Scan	21
DSC calls	22
Replay function	37
Settings	38

Chapter 3 Service & maintenance

Contact for support	53
Maintenance	53
Status signaling	55
Replacing the fuse in the Transceiver Unit	57
Warranty and returning units for repair	58

Appendix A Specifications

SAILOR 7226 VHF Transceiver Unit	59
SAILOR 7224 Control Unit	61
General DSC specifications	63

Appendix B Maritime channels

International channels (INT)	65
US channels (US)	66
Canadian channels (CA)	67
Binnenwasser channels (BI)	68
Alternative channels (ALT)	69
Private channels (P)	69
Glossary	71
Index	75

Introduction

VHF radio with DSC Class A

Exceeding standards set by IMO regulation for GMDSS Class A VHF, the August 2021 introduced Bridge Alert Management IMO resolution MSC.302(87), as well as IEC 62923-1 & IEC 62923-2, the SAILOR 7222 VHF DSC Class A is a robust platform for when clear communication could make the difference between a non-event and a major incident.

As part of the required safety equipment, use the SAILOR 7222 VHF DSC in an emergency situation. However the best way to guarantee functionality in an emergency situation, is to use the radio in daily communication on board.

The VHF radio is a simplex/semi duplex VHF radio consisting of two units connected with a standard Ethernet cable:

- SAILOR 7224 Control Unit
- SAILOR 7226 VHF Transceiver Unit

It is designed with an easy-to-use menu-driven setup. You use the touch screen on the SAILOR 7224 Control Unit or a connected device with a browser to enter the desired functions. You can also select channels using the rightmost selection knob. The large display can be customized for optimum readability and visibility both day and night with different color themes.

The VHF radio can replay 480 seconds of received voice messages. This is a useful feature to minimize misunderstandings and to record messages when the radio is unattended.

With SAILOR connection boxes the VHF radio connects easily to external equipment like a BAM system, additional handsets, water proof hand microphones, control speaker microphone, alarm panel or external speaker. The



Ethernet interface connects the Control Unit with the Transceiver Unit, and enables the VHF radio to be connected to other units in a local network. Instead of the touch screen on the Control Unit, you can also connect a PC or other device with a browser for setup and control via the web interface.

For a list of accessories available for the VHF radio see *Accessories available* on page 4 and check with your nearest distributor.

Controls on the front plate of the Control Unit



Figure 1: Controls on the front plate of the Control Unit

1. Loudspeaker.
2. Large 5.5" TFT display with capacitive multi touch.
3. Volume control, on/off and Squelch control.
4. Distress button for sending a Distress alert.
5. Channel selector and dim knob with push-function to switch between channel selection and dimming.

SAILOR 7222 VHF DSC display

The picture shows the display after start-up. The display holds various fields of information, depending on the currently selected function.

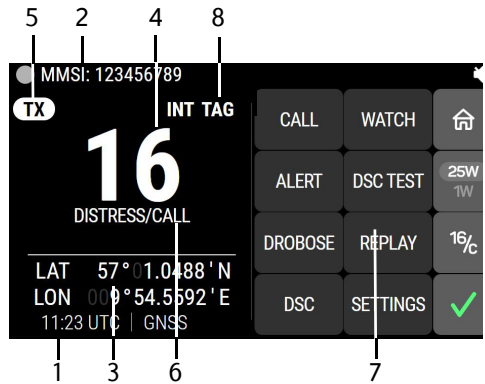

1. UTC time.
2. MMSI number.
3. Position information (latitude and longitude).
4. Current working channel.
Tap to get an on-screen keyboard for changing the working channel.
5. Current communication direction: Rx (receive) or Tx (transmit).
6. Service line containing current temporary information relevant for the current channel or function.
7. On-screen key functions.
8. Channel properties of the currently selected VHF channel (if any).





For a detailed description of the information shown for each of the functions available see the chapter *Operation* on page 9.

Accessories available

Part number	Description	
406201A-00500	SAILOR 6201 Handset with cradle (additional)	
406203A-00500	SAILOR 6203 Handset with cradle, waterproof to IPx6.	
406202A-00500	You can use the SAILOR 6202 Hand Microphone (waterproof to IPx6 and IPx8) instead of the handset.	
406204A-00500	With the SAILOR 6204 Control Speaker Microphone (CSM) you can control the VHF voice functions of the SAILOR 7222 VHF DSC.	
406207A-00500	The SAILOR 6207 Connection Box for parallel Handsets including Connection Cable 406209-941 is used for easy installation of several SAILOR 6201/SAILOR 6203 Handsets.	

Part number	Description
406208A-00500	<p>SAILOR 6208 Control Unit Connection Box including Connection Cable 406208-941 is used for easy installation of external equipment and accessories:</p> <p>Max. 4 SAILOR 6204 Control Speaker Microphones VDR SAILOR 6270 External Loudspeaker Alarm panels and GNSS input</p> 
406209A	<p>SAILOR 6209 Accessory Connection Box is used to connect the OPT connector on the Control Unit to a Bridge Alert Management unit (BAM).</p> 
406209-940	<p>Cables:</p> <p>5m connection cable for bulk mount, 1x10 pole: Use this cable to connect a handset to a SAILOR 6207 or SAILOR 6209 Connection Box in installations where the handset is not connected directly to the SAILOR 7222 VHF DSC, but located in a different position.</p>
406209-941	<p>5m connection cable, 1x10 pole: Use this cable to connect the Control Unit to a SAILOR 6207 or SAILOR 6209 Connection Box in installations where the handset is not connected directly to the SAILOR 7222 VHF DSC, but located in a different position.</p>
406208-941	<p>5m connection cable, 1x12 pole: Use this cable to connect the Control Unit to a SAILOR 6208 Connection Box.</p>
406204-940	<p>5m connection cable, 1x12 pole: Use this cable to connect a SAILOR 6204 Control Speaker Microphone to a SAILOR 6208 Connection Box.</p>
406270A	<p>If you need an additional external loudspeaker you can connect a SAILOR 6270 External Loudspeaker.</p> 

Part number	Description
406103A-00500	<p>With the SAILOR 6103 Multi Alarm Panel you can activate GMDSS Distress Alarms. The Multi Alarm Panel can be connected to the SAILOR 7222 VHF DSC via the Ethernet interface (LAN connector).</p> 
406197A-00500	<p>The SAILOR 6197 Ethernet Switch is used in installations with SAILOR 6103 Multi Alarm Panels and in installations with a local network. The Ethernet switch has 5 ports.</p> 
80119410	<p>The N163S Power supply provides 24 VDC for the SAILOR 7222 VHF DSC.</p> 

System configuration - example

The SAILOR 7222 VHF DSC can be customized to suit your installation. The following illustration is one example of a system. For further configuration examples see the installation manual, Appendix B, System configurations.

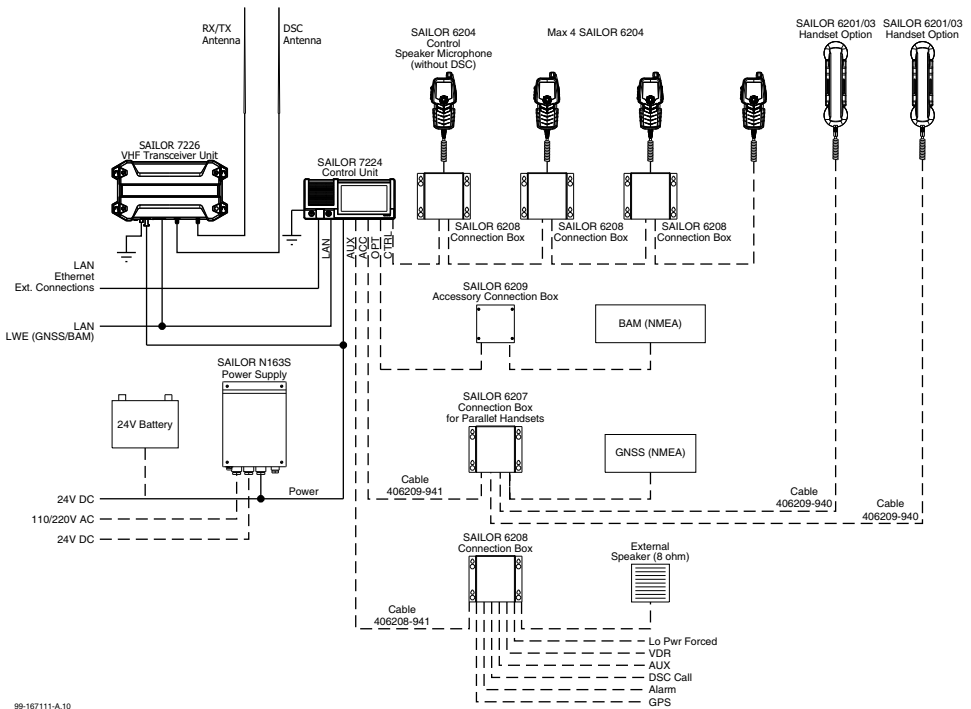

Figure 2: System configuration, example

Operation

Note

Before using the VHF radio make sure that the VHF and DSC antennas, power cable and other external equipment are connected properly. For installation instructions see the *SAILOR 7222 VHF DSC, Installation manual*.

In this chapter you find detailed instructions and guidelines for:

- *General use and navigation*
- *VHF radio communication*
- *Watch*
- *Scan*
- *DSC calls*
- *Replay function*
- *Settings*

General use and navigation

Introduction

The SAILOR 7222 VHF DSC consists of two units: The SAILOR 7224 Control Unit (called Control Unit in this manual) and the SAILOR 7226 VHF Transceiver Unit.

The Control Unit holds the user interface and is used to control the system.

Power on, volume and squelch

The Control Unit has a triple-function knob for power on, volume control and squelch control.



To turn on the VHF radio push the on/off knob.

To turn off the VHF radio, push and hold the on/off knob and follow the instructions in the display,

To adjust the speaker volume, turn the volume knob (clockwise = louder, counter clockwise = softer, until muted). When muted,  is shown in the display.

To adjust the volume of the handset earpiece see *RADIO* on page 40.

To adjust the squelch level, push the button briefly and turn the knob (clockwise = suppress noise more, counterclockwise = suppress noise less). The display shows the squelch level.

With the squelch control you can manually adjust and suppress noise in order to optimize the quality of the received radio communication.

Working channel and dimming the display

Use the **channel selector knob** to select a channel, or to dim the light in the display:

- To select a **working channel** use the channel selector knob or enter the channel number using the on-screen keypad.



Note

A tap on the 16/C on-screen key always brings you to channel 16, the international calling and distress channel, no matter what state the radio is in.



- To adjust the light in the display, push the button briefly. The display shows a dimming bar. Turn the knob to adjust the light (clockwise = brighter, counterclockwise = darker).

Speaker devices

The VHF radio can be equipped with the following speaker devices:

- SAILOR 6201/SAILOR 6203 Handset with cradle and PTT (Push To Talk) button.
- SAILOR 6202 Hand Microphone with PTT button.
- SAILOR 6204 Control Speaker Microphone with PTT button.

See *ABOUT* on page 51 for controlling the connected speaker devices.

DSC and MMSI number

The MMSI is a unique, 9-digit identifier assigned to your ship. When the VHF radio is powered on for the first time, the vessel's MMSI number is programmed in the radio. This is typically done during installation of the radio and described in the installation manual.

Important

The MMSI number must be programmed into the VHF radio to use any DSC functionality. The radio will prompt for the MMSI number at each power-up until the MMSI has been entered. You can use the radio in normal VHF mode.



WARNING!

Without a programmed MMSI number the Distress button will not work!

Position and MMSI number

In idle mode, the DSC window always shows the UTC time, position and MMSI number for the SAILOR 7222 VHF DSC radio.



Enter position manually (no GNSS)

If you need to enter the vessel's position and UTC of position manually, do as follows:

1. Tap **Settings** on the screen menu. If it is not in the display, tap  and then **Settings**.
2. Tap **DSC**.
3. Tap **Position**.
4. Tap **Source** and select **Manual**.
5. Enter the current position and UTC time:
 - Latitude,
 - Longitude
 - Time (UTC time)

Tap on the screen to select the value you want to change. Then use the on-screen keypad to enter the current values for position and UTC time.

6. Tap **SAVE**. The display shows **MANUAL** in the lower left corner.

If the GNSS was present and then disappears, a warning appears in the display after 10 minutes, then you can enter the position and UTC time manually as described above.

Idle screen (Home)

Idle screen

Below is the idle screen with explanation of the various fields. You can always return to the idle screen by tapping 

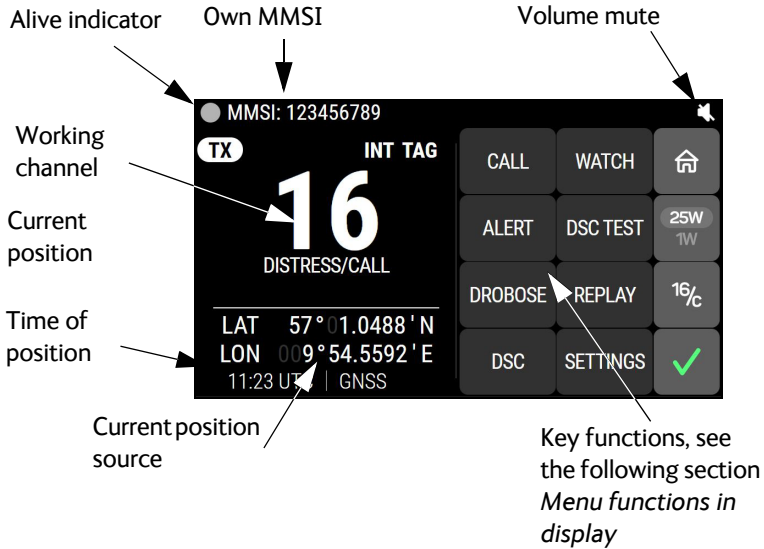

Change channel

A tap on the working channel number will bring up a numeric keyboard where you can enter a new channel number.

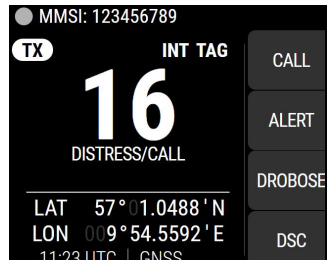



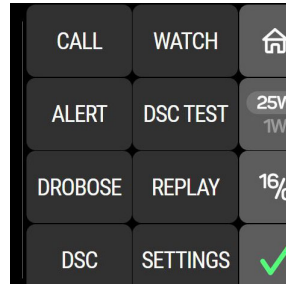

Menu functions in display

A number of functions of the SAILOR 7222 VHF DSC are accessed using the on-screen keys in the right side of the display.

The following on-screen key functions are available from top-level standby:



On-screen key	Function
CALL	Make DSC non-distress calls
ALERT	Make a distress call with assigned category
DROBOSE	Make a distress relay call on behalf of someone else
DSC	Manage DSC sessions
WATCH	Access the watch functions DW (Dual watch), TW (Triple watch) and Scan.
DSC TEST	Make a DSC test call, see <i>DSC self test</i> on page 53
REPLAY	Replay the latest voice message.
SETTINGS	Setup pages for <i>RADIO, CONTROLLER, CHANNELS, DSC, POWER SUPPLY, NMEA, NETWORK, SYSTEM, REMOTE CONTROL</i> and <i>ABOUT</i> .
 Home	Return to the idle screen
 1W/25W	Toggle transmit power between 1W and 25W.

On-screen key	Function
 16/C	Shift to channel 16 , the international calling and distress channel, no matter what state the radio is in.
 Status/ Alerts	Status and alert list The icon changes when an alert message is reported in the Bridge Alert Management (BAM) system. Tap the icon to see the alert list.
	In the first example (check mark), there are no active alerts. In the second example (exclamation mark), there is a Warning: Active acknowledged alert. If there is a number on the icon, it shows the number of unread alerts. For possible icons, see <i>List of alert icons</i> on page 55.

Changing the display light, night view

Red text on black background is available for optimal night vision.

To **dim the display backlight**, e.g. to give comfortable night vision, push the channel selector knob briefly. The display shows a brightness bar. Turn the knob anti-clockwise to dim more. At the brightness value 45 the display changes to **night view** with red text on black background.

To **return to day vision** push the channel selector knob briefly and turn it clockwise until the display changes and it reaches the desired brightness.

The radio has four color themes: Dark, Light, Cobham and Night. To change the color theme see *SYSTEM* on page 49.

Adjusting the squelch level

With the Squelch control you can manually adjust and suppress noise in order to optimize the quality of the received radio communication.

When hearing noise or an unwanted signal, push the Volume/squelch button briefly, check that the squelch bar is visible on the display and turn the squelch button clockwise until the radio is muted.



Use with a SAILOR 6204 Control Speaker Microphone

When a SAILOR 6204 Control Speaker Microphone is connected to the radio, you can operate the radio with the Control Speaker Microphone. An **OCCUPIED** message is shown in the radio's display. At any time you can take control over the VHF radio by touching the screen or pushing any button on the radio.

VHF radio communication

Basic VHF operation

You can make VHF calls using the Handset or another speaker device.

Note

A tap on the **16/C** on-screen key always brings you to **channel 16**, the international calling and distress channel, no matter what state the radio is in.



Quick guide to radio telephone calls

1. Push the **PTT** button on the speaker device. When the TX indicator is highlighted in the display, the transmission is active.
2. To enable reception of a radio signal release the **PTT** button.



Note

Push **PTT** only when you are talking. Always say "Over" just before releasing the PTT button.

One transmission is limited to **5 minutes** duration.

Receiving a radio telephone call on channel 16

When you hear your call name in the loudspeaker, proceed as follows:

1. The symbol **RX** shows that the radio is receiving on the channel displayed.
2. Lift the Handset or take another speaker device.
3. Push the **PTT** button. The symbol **TX** shows that the radio is transmitting on the channel displayed.
4. Repeat the name of the station calling you and say: "This is [your ship's name]".
5. Suggest a working channel other than 16 by saying: "Channel [suggested channel number]".
6. Say: "Over." and release the **PTT** button to allow the caller to confirm the suggested new channel.
7. Switch to the new channel using the on-screen keypad or by turning the channel selector knob to the agreed channel and begin your conversation. Push **PTT** only when you are talking.

Making a radio telephone call on channel 16

To make a radio telephone call, proceed as follows:

1. Select channel 16.
2. Lift the Handset or take another speaker device.
3. Push the **PTT** button. The symbol **TX** shows that the VHF radio is transmitting on the working channel displayed.
4. Say the name of the station you are calling three times.
5. Say: "This is [your ship's name]".
6. Say: "Over." and release the **PTT** button to listen. The symbol **RX** shows that the radio is receiving on the working channel displayed
7. When answered, agree upon a working channel other than 16.
8. Switch to the new channel by entering the channel number to the agreed channel and begin your conversation.



VHF channels

Enter the channel using the on-screen keypad or turn the channel selector knob to browse through all channels that are available in the selected channel table. Only valid channel numbers are accepted. When browsing channels they appear in the display in the following order:

- Primary channels
- Weather channels (if any)
- Private channels (if any)

When you tap and hold the 16/C key in the display the radio changes to the call channel (channel 16 for the channel tables INT and BI, and channel 9 for the channel tables US and CA, if no other channel is programmed in *CHANNELS* on page 42).



VHF channel table	Description
Primary channels (no prefix)	For details see <i>Maritime channels</i> on page 65. For instructions how to change a channel table see <i>CHANNELS</i> on page 42.
Weather (Wn)	Weather channels have the prefix W . (For US and CA channels only.)
Private (Pnn)	Private channels have the prefix P . Up to 100 user-defined private channels.

For more information on how to set up channels see *CHANNELS* on page 42. Contact your local dealer if you are interested in having private channels.

Channel information always available in the display

For some functions and for setup pages, the channel and radio information has moved to the top right section of the display.

The channel number displayed in this section always reflects the communication channel to which the radio is tuned in for communication. If **PTT** is pushed the radio transmits on the displayed channel. If a signal is received, it is received on the displayed channel.

(Example)

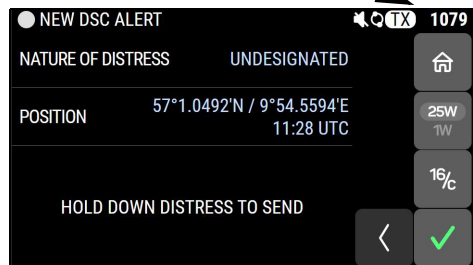

Engagement status

The radio is engaged when you push **PTT**. This is indicated with  in the display. Engagement protects the communication from being interrupted by incoming DSC calls.

Reduced transmission power

Tap the on-screen key **1W/25W** to toggle the transmit power between 1 W and 25 W.



Watch

The SAILOR 7222 VHF DSC radio has a watch function with dual or triple watch. In dual watch, the working channel and channel 16 are watched. In triple watch the working channel, channel 16 and the programmed call channel are watched. You can select the working channel in any watch mode by turning the channel selector knob. If there is a signal in one of the watched channels, the display shows the channel in which the signal is received.

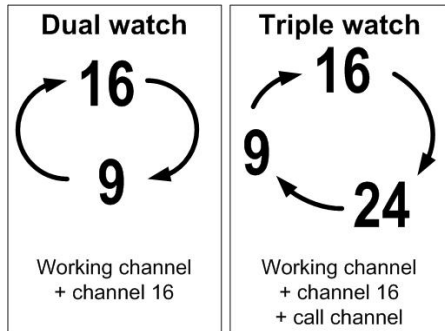

For instructions how to set up **TRIPLE WATCH** see *RADIO* on page 40.

To start the watch function tap the key **WATCH** and then **DUAL WATCH** or **TRIPLE WATCH**.

The radio enters the selected watch mode and the text **WATCH** with the channel numbers watched is shown below the current channel number.

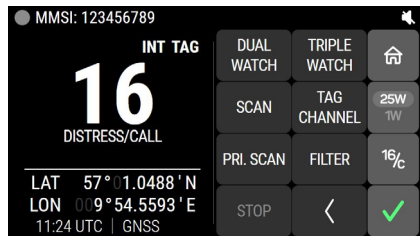

An icon,  at the top bar of the display shows dual watch (two dots) or triple watch (three dots) or scan (one dot and an M for Multi-scan).

To stop the watch function tap the **WATCH** key and then **STOP** or **PTT** on the speaking device.

For details on the **Scan** function, see the next section.

Scan

The radio has a scanning function for tagged voice channels. Any available voice channel, including weather and private channels, can be tagged and added to the scanning sequence. As default the radio scans with priority scanning of channel 16. If a signal is received while in any scanning mode, only channel 16 continues to be watched.

If there is a signal in one of the scanned channels, the display shows the channel in which the signal is received. If PTT is pushed while scanning, the scanning stops, the radio is tuned into the displayed channel and transmission starts immediately on the displayed working channel.

To start scanning tap **WATCH** and then **SCAN**.

To stop scanning tap **WATCH** and then **STOP**, or push **PTT** on the speaking device.

To tag a channel for scanning:

1. Turn the channel selector knob until the wanted channel is in the display.
2. Tap **WATCH** and then **TAG**. The display shows the channel number and the word **TAG** at the right side of the display.

To remove a channel from the scanning sequence:

1. Turn the channel selector knob until the tagged channel is displayed.
2. Tap **TAG** to remove the tag.

To see only tagged channels tap **WATCH** and then **FILTER** and turn the channel selector knob. Tap **FILTER** again to leave the FILTER function. For details how to set up the scanning function see *RADIO* on page 40.

Note

The displayed working channel is temporarily included in the scanning list (although no TAG icon is shown).

DSC calls

In this section of the manual you find information on:

- *View and manage DSC calls*
- *Send, acknowledge and cancel own distress*
- *DROBOSE — Distress Relay on behalf of someone else*
- *Receiving distress calls*
- *DSC calls for communication*

View and manage DSC calls

What is a DSC session

A DSC session is a collection of DSC calls (transmitted and/or received) that are related to the same event (e.g. a distress event) or established call (e.g. an individual call request followed by an acknowledgment).

A session can be either active or on hold. The active session has control over the radio transmitter. A session can have a purpose. For example if the purpose is to establish communication on a working channel.

The non-DSC VHF communication is considered as a session that can be active (engaged) or on hold (dis-engaged). See also *Engagement status* on page 19.

Display for active DSC session

When a DSC session is active, the display shows the type of session, the current state, MMSI number of the other party and elapsed time since the reception of a call request or an acknowledgment.

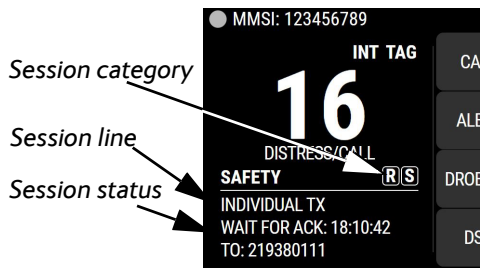

Note

The session category **text** (in this example **DISTRESS**) is for the active call. The session category **icons** show the category of the other ongoing sessions

Session line:

The DSC Session line can be one of the following:

Session line	Explanation
OWN DISTRESS	The ship is in own distress. See also <i>To send a distress message</i> on page 28.
DISTRESS RX	You watch or participate in a distress communication for another station in distress
DISTRESS RX (MOB)	You watch or participate in an MOB distress event involving one or more MOB devices
RELAY calls (numerous)	You watch or participate in a distress communication for another station in distress
ALL SHIPS TX/RX	You have sent / received an all ships call
GROUP TX/RX	You have sent / received a group call
INDIVIDUAL TX/RX	You have either sent a call request to a station to establish contact, or another station has made a call to you to establish contact. The call needs a reply.
TEST TX/RX	You have either sent a SAFETY TEST call or you have received a SAFETY TEST call from another station that needs to be replied to.
POSITION TX/RX	A position request was either sent or received.



Session status:

The session status can be one of the following:

Session status	Explanation
WAIT FOR ACKNOWLEDGE	You made an individual call to a station and are awaiting a reply to establish connection.
OCCUPIED	The DSC transmission mechanism waits until the DSC channel (70) is free.
TRANSMITTING	Transmission of a DSC message is ongoing.
LINK FOR COM	The communication has been established in a routine call.
ACKNOWLEDGED	The call has been acknowledged.

Session category icons:

Session category icons in the session view show the categories of all DSC call or Voice communication in the list:

- D — Distress
- O — Own distress
- U — Urgency
- S — Safety
- R — Routine
- ? — Unknown category (error in message)
-  — Voice (VHF voice call, non-DSC)
-  — MOB Distress event (closed loop/open loop)

On-screen keys to control DSC sessions

Call or session types vary in control options, and options may also change if a session changes its state.

The following table gives an overview of the DSC on-screen key commands available for a current session. Note that only a subset of these keys are available, depending on the session type, state etc.

On-screen key — DSC session	Radio function
MORE	Available for all sessions. Under MORE you find SELF TEST (<i>DSC self test</i> on page 53), CALL LOGS (<i>DSC call logs</i> on page 36) and HISTORY (<i>Distress call log</i> on page 33?).
QUIT	Terminates the DSC session
HOLD	Puts the DSC session hold if it is active (return to other non-DSC functions)
ACTIV.	Activates the DSC session
RESEND	Transmits an identical call if available
NEW CH	Replies with a new channel if an individual call is received with a communication channel specified which is not available in the radio, or the operator decides to change the channel.
UNABLE	Constructs a reply to the caller if an individual call is received which is not compatible with the radio modes.
SILENT	Silences alarms.
ACK	Acknowledges a received call request with the suggested parameters.
POSITION (Own Distress)	A shortcut to own position data information.

On-screen key — DSC session	Radio function
PAUSE (Own Distress)	Pauses the automatic repetition of distress transmissions
RESUME (Own Distress)	Resumes automatic repetition of distress transmissions (if paused)
ACK	Distress acknowledgment.
RELAY	Distress Relay on behalf of someone else.
CANCEL (Cancel Own Distress)	Cancels an inadvertently transmitted distress
CONFIRM (Cancel Own Distress)	Confirms action and proceed sequence, used in cancel distress procedure

Access all DSC sessions

The SAILOR 7222 VHF DSC can control multiple DSC sessions simultaneously with a VHF communication session. All sessions can keep track of their session state and the communication channel used. They are handled in their respective sessions, in the order they are started up.

Note

Note that there is only one active session at a time. The active session controls the radio transmitter.

To see all DSC sessions, tap DSC in the display.

All sessions are listed in the left side of the display, with session category and MMSI number. The active session is marked **ACT**.

Blue arrow is outgoing call, green arrow is incoming call.

The center of the display shows details for the selected (highlighted) session in the list.

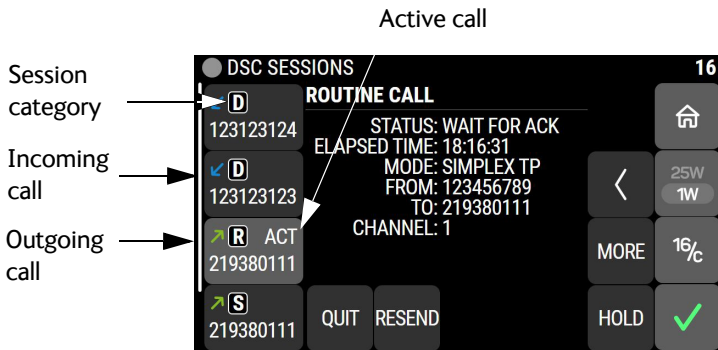

You can toggle between the ongoing calls/sessions, that means that a call — or session — can be on hold or active.

The DSC sessions on hold can receive calls that are pertinent to the session, even when the session is not displayed.

The example on this page shows four sessions ongoing. Swipe vertically to scroll through all sessions. The selected session is highlighted, and the details for the selected session is shown in the center of the display.

If engaged in a DSC session and if you want to engage in a non-DSC voice communication, tap **HOLD** on the active DSC session and then push **PTT** to engage.

Send, acknowledge and cancel own distress

To send a distress message

1. Lift the cover of the red distress button and push and hold the distress button for longer than 3 seconds. For short step-by-step instructions how to proceed when sending a distress message see *Emergency calls* on page vi.

When the distress signal is sent, **70** and **TX** appear in the top line of the display. A two-seconds steady tone is heard.

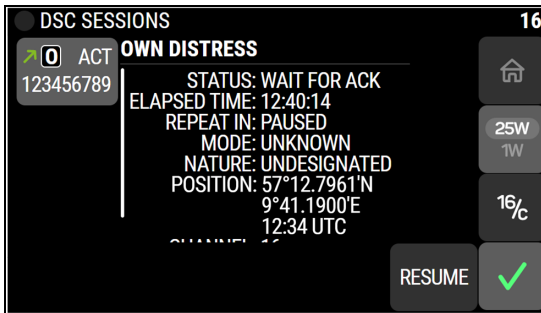

2. The radio watches for a DSC acknowledgment transmission on channel 70.
3. To pause the automatic resend procedure tap **PAUSE / RESUME** in the display.
4. To cancel the distress message tap **CANCEL**. See also *To cancel own distress* on page 30.
5. When a distress acknowledgment is received, a pop-up window is displayed. The channel number falls back to 16. Start distress communication on channel 16 to inform about your distress situation.

Note

If no distress acknowledgment is received within a period of 3,5 to 4,5 minutes, the distress message will automatically be retransmitted.

Having pushed the red distress button and sent the distress message, the following information is displayed:

- MMSI (at the top): Shows the MMSI number of the VHF radio.
- UTC time is shown at the top left
- Status: shows the status of the Distress process, e.g. “Waiting for ACK”.

- Nature: shows the nature of distress, see also *ALERT: To send a distress message with specified nature*.
- LAT: and LON: shows the distress position data as transmitted.
- Elapsed time: Time elapsed after initiation of own distress.
- Resending in: Time to next repeat of sending own distress.

If you sent a distress message, the VHF radio is automatically set to channel 16, the channel reserved for international distress, safety and calling.

ALERT: To send a distress message with specified nature

When sending distress messages you can include the distress nature in the message. To include the distress nature in the distress message do as follows:

1. From top-level standby tap **ALERT**.
If the current position information is not correct, you can manually enter it by tapping **POSITION**.



2. Tap **NATURE OF DISTRESS**, then scroll in the display to select the relevant nature of distress:
 - FIRE, EXPLOSION
 - FLOODING
 - COLLISION
 - GROUNDING
 - LISTING (in danger of capsizing)
 - SINKING
 - DISABLED (and adrift)
 - UNDESIGNATED
 - ABANDONING (ship)
 - PIRACY (armed robbery attack)
 - MAN OVERBOARD
3. Tap to accept the selected nature of distress.
4. Then lift the cover of the red distress button and push and hold the **Distress button** for 3 seconds.



To receive acknowledgment of own distress

When the SAILOR 7222 VHF DSC receives an acknowledgment of distress from another vessel or station, a 2-tone alarm sounds. The display shows a pop-up window with the MMSI number of the station who sent the distress acknowledgment call.

- Tap **SILENT** to switch off the 2-tone alarm.
- Tap **HOME** to return to the working display.

If the same Distress call comes in more than once, the 2-tone alarm sounds briefly and terminates automatically.

To cancel own distress

If you need to cancel a sent distress message do as follows:

1. The display shows that a distress message has been sent. Tap **CANCEL**. A pop-up window is displayed.
2. Tap **Yes** to go ahead with the canceling process. At this stage you have the option to tap **No** to return to distress sending procedure.
3. The SAILOR 7222 VHF DSC will send the self-cancellation call on channel 70 and the display automatically shows the message that you should say when canceling the distress with a radio message.
4. Tap **OK** to go to the acknowledged state. Own distress is canceled now.
5. Tap **CANCEL** to repeat the sending of the cancel DSC message.
6. Having finished the voice canceling, tap **QUIT** to quit the distress annulment procedure.

Power failure while in distress

In case of a power failure or switch-off during the transmission of a Distress the SAILOR 7222 VHF DSC gives an audible warning after power-up and automatically resumes sending Distress 10 seconds after power up.

Within the 10 seconds you have the following options:

- Tap **QUIT** to terminate the active distress procedure (acknowledged or unacknowledged).
- Tap **CONFIRM** (or wait and do nothing) to resume the sending Distress procedure.

Sending a Distress from the SAILOR 6103 Multi Alarm Panel

The optional SAILOR 6103 Multi Alarm Panel will, when connected to the VHF radio, indicate in the SAILOR 6103 Multi Alarm Panel display that a Distress can be sent over VHF. To send a Distress alert from the SAILOR 6103 Multi Alarm Panel, do as follows:



1. Lift the cover of the Distress button marked **VHF**.
2. Push and hold the button until the light is steady and the buzzer stops (more than 3 seconds).

The VHF radio is now in distress mode. Continue the distress traffic and procedures from the VHF radio front panel, if possible, in the same way as described for handling distress mode from the VHF radio.

Note

Only undesignated distress messages can be initiated from the Alarm Panel.

For further information see the Alarm Panel Installation and user manual.

DROBOSE — Distress Relay on behalf of someone else

To send a distress message on behalf of someone else, do as follows:

1. From top-level standby tap **DROBOSE**.
2. Tap one line at a time and enter the necessary information using the on-screen keypad:

Relay items	Description
TYPE	Select RELAY ALL or RELAY INDIV. If yo select RELAY INDIV., the field TO appears in the display.
DISTRESS MMSI	Enter the MMSI number of the vessel in distress, if known, or else Unknown .
TO	Enter the MMSI number of the coast station you send the relay to.
NATURE	Select the nature of distress: FIRE, EXPLOSION FLOODING COLLISION GROUNDING LISTING (in danger of capsizing) SINKING DISABLED (and adrift) UNDESIGNATED ABANDONING (ship) PIRACY (armed robbery attack) MAN OVERBOARD EPIRB
POSITION	Enter the longitude, latitude and time (UTC) information of the vessel in distress if known, or else Unknown .

3. Tap **SEND**.

Receiving distress calls

When the radio receives a distress call, the 2-tone alarm sounds. Types of distress calls are DISTRESS, DISTRESS ACK, DISTRESS RELAY and DISTR. RELAY ACK.

1. To switch off the 2-tone alarm tap **SILENT**.
2. If engaged in other communications tap **ACTIVATE** to engage in the received DSC call.
3. Monitor channel 16 as a coast station may require your assistance. If the radio is not on channel 16, turn the channel selector knob or use the key **16/C** to go to channel 16.
4. When the radio receives the first distress acknowledgment call a 2-tone alarm sounds again. To switch off the 2-tone alarm tap **SILENT**.
5. If you decide to acknowledge the Distress tap **ACK** in the display.

Distress call with errors

If a distress call contains errors, it is still received.

Tap **OK** on the popup and tap **DSC** for more information. Errors are marked with underscores (_).

Distress call log

As long as you are part of a distress session, i.e. you have not tapped **QUIT**, you receive distress messages and can track all distress messages for the current distress event.

1. Tap **MORE**.
2. **HISTORY**.
3. Use the list in the left side to see details for the messages.
4. Tap **<** to leave the event history.

Receiving distress calls from Man Over Board devices

The SAILOR 7222 VHF DSC supports specific handling of Man Over Board devices (MOB). The MOB device can operate in a closed loop configuration (sending distress relay calls) and/or open loop mode (sending distress calls).

A specific received distress session is initiated for MOB devices.

Any call which originates from a modern MOB device will be handled within a single procedure. You will be able to see the acknowledgment status of (up to 50) involved MOB devices in parallel.

Tap **DSC** and select the relevant session in the left side. At the top of the session details you can see the number of MOB sessions (in the example we are watching MOB session 1 out of 50). Browse through all MOB devices using the < and > buttons.

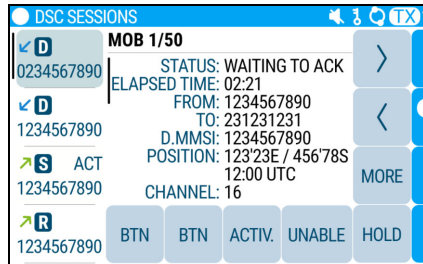

The MOB distress relay calls (closed loop) can be relayed or individually acknowledged when the person is located or secured.

MOB distress calls (open loop) may be acknowledged only if permitted by a coast station.



DSC calls for communication

With a DSC call you can establish a radio communication with one or several specific radios on a suggested VHF channel.

 <p>VHF Radio A</p>	<ol style="list-style-type: none"> 1. Make a DSC call from Radio A to Radio B. 2. DSC acknowledge from Radio B to Radio A. 3. Radio A + B go on the agreed VHF channel. 4. Press PTT and start talking. 	 <p>VHF Radio B</p>
---	---	---

To make a DSC call, do as follows:

1. Tap **CALL**.
2. Tap **TYPE** and scroll and tap to select the call type.

Depending on the DSC call type you can enter category, MMSI number and channel for the following communication.

3. In the field **CATEGORY**: select a DSC call category, depending on the call type.

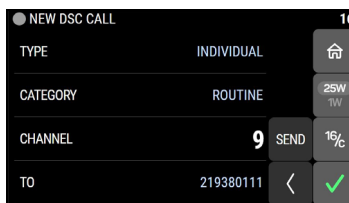

DSC call type	Cat.	To:	Ch.	Session icon	DSC call category
INDIVIDUAL (default)	X	X	X	U, S or R	Routine (default), urgency or safety calls, calls to a ship or a station
SAFETY TEST	—	X	—	S	Test call, check of safety equipment
POSITION	—	X	—	S	Safety
GROUP	—	X	X	R	Routine
ALL SHIPS	X	—	X	S or U	Safety (default) or urgency

4. In the field **TO**: enter the 9-digit MMSI number of the vessel you want to contact.

DSC calls

5. In the field **CHANNEL**: enter the suggested VHF channel for following communication.
6. Tap **SEND** to make the call.

Receiving DSC calls

If the radio is in stand-by mode, i.e. not engaged in another session, and a DSC call is received the call details are shown on the display.

After having silenced the alarm you can acknowledge the call, put it on hold or display more information.

DSC call logs

To access the call logs, tap **MORE** and then **CALL LOGS**.

DSC call log	Description
Received Distress	Shows a log of up to 100 received distress calls.
Transmitted Calls	Shows a log of up to 100 transmitted calls.
Received Calls	Shows a log of up to 100 received non-distress calls.

Replay function

Replay allows the operator to playback received voice messages in the loudspeaker. Recording is activated automatically when a chosen channel becomes active. Recording is not possible during playback. Up to 60 tracks or 480 seconds can be handled. During a power cycle the recorded tracks are deleted.

The recorded channel is displayed. The message length is shown in seconds. The display shows how old the message is. If the 480 seconds storage limit is reached, the oldest data is overwritten.

Note

The replay function can be started even in a distress situation. If a DSC call is received the replay function continues the playback. Acknowledgment of the DSC call immediately initiates and activates the DSC session. You can initiate replay again from any session afterwards.

Replaying recorded messages

From the idle screen, tap the **REPLAY** button.

The latest message is repeated. Information about this message is shown in the display.

To stop replaying the message, tap **STOP**.

To rewind through the recorded messages tap **REWIND**.

If a signal is received while in replay mode the display shows **RX** at the top. You can now select whether to exit replay and listen to the active channel or wait for the channel to become inactive and then replay the latest track.

Settings

The following settings pages are described in this section of the manual:

- *RADIO*
- *CONTROLLER*
- *CHANNELS*
- *DSC*
- *POWER SUPPLY*
- *NMEA*
- *NETWORK*
- *SYSTEM*
- *REMOTE CONTROL*
- *ABOUT*

Accessing a settings page

To change a setting in one of the **SETTINGS** pages, do as follows

1. Tap **SETTINGS**. If it is not in the display, tap  and then **SETTINGS**
2. Tap the settings page you want to edit.

Note

Settings requiring a password are marked with a lock icon . You can see these settings without a password, but you cannot edit them. For more detailed information on these settings, see the *SAILOR 7222 VHF DSC, Installation manual*.

3. Tap  to go one step back, or  to return to normal radio operation.

SETTINGS menu overview

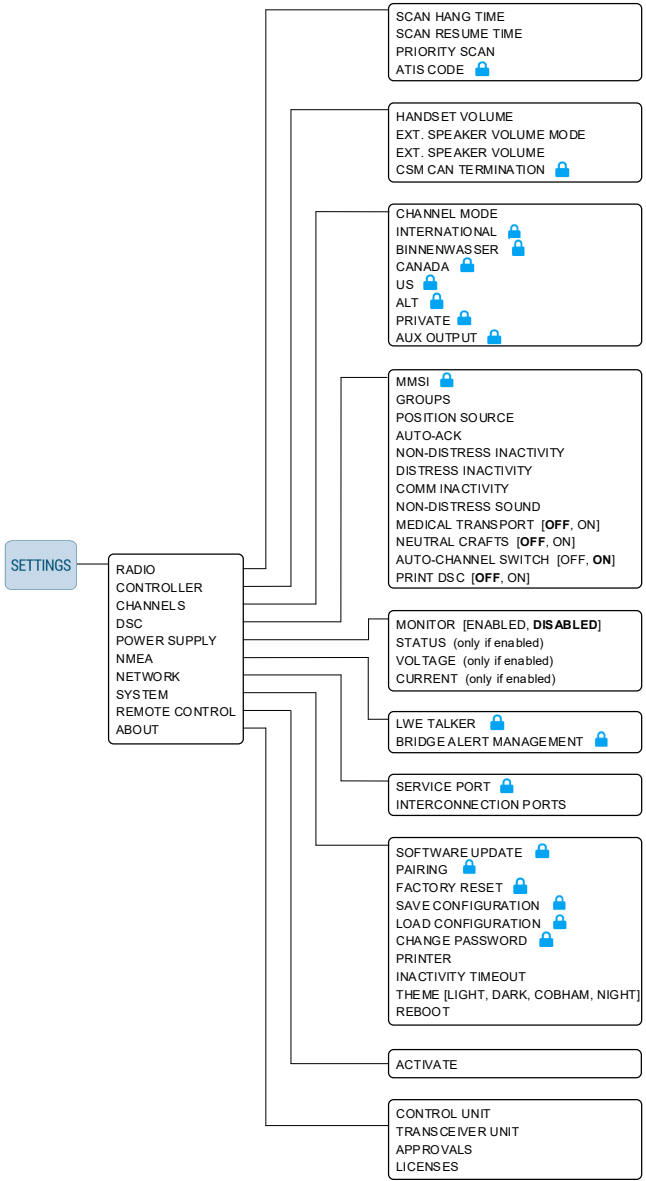

RADIO

Parameter	Description
SCAN HANG TIME	<p>Scan hang time, in seconds on an active receiving working channel. The time is measured from the signal is detected. The radio remains on the channel for the set time interval, if a signal was detected.</p> <p>OFF: Resumes scanning when signal disappears (default) 4, 6, 8, 10: Hang time in seconds.</p>
SCAN RESUME TIME	<p>Scan resume time, in seconds. When the programmed time of inactivity has elapsed, and when watch/scan has been aborted using a push on PTT, or after power-up, scan or watch is resumed.</p> <p>OFF: Automatic resume is deactivated (default) 3, 6, 10, 15, 20, 25, 30: Resume time in seconds.</p>
PRIORITY SCAN	<p>ON: All channels tagged for scanning are scanned while monitoring channel 16. (default).</p> <p>OFF: Only the channels tagged for scanning are scanned in sequence, not channel 16, unless it is tagged for scanning.</p>
ATIS CODE 	<p>10 digit numerical (Default: not set, password protected if set)</p> <p>The ATIS code is used for identification to marine coast and inland stations and its use is mandatory in a number of European inland waterways. The ATIS number is issued by the relevant authority.</p> <p>For ships coming from states which are not member of the Regional Arrangement, the ATIS-Code is based on the MMSI with a 9 as the first digit.^a</p>



a. The Committee RAINWAT in its 12. Meeting (October 2008) decided to change the building rules of the ATIS code for vessels coming from a country outside the RAINWAT arrangement.

CONTROLLER

Each of the controlling devices connected and powered has its own setting. The available settings may vary from controllers applied.

Parameter	Description
HANDSET VOLUME	Adjust earpiece volume for handset 1: ON, can be adjusted from OFF to 100, in steps of 5.
EXT. SPEAKER VOLUME MODE	FIXED: Fixed level is set for external speaker RELATIVE: Relative level following volume adjustment of the internal speaker
EXT. SPEAKER VOLUME	External speaker fixed volume: OFF , 5 to 100 in steps of 5
CSM CAN TERMINATION 	Termination of the CAN interface in the VHF radio: ON or OFF

CHANNELS

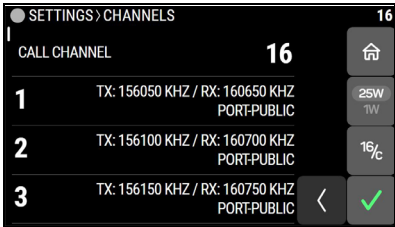
Parameter	Description
CHANNEL MODE	<p>Select CHANNEL MODE to select the channel table for the primary channel. Channel tables available: INT, BI, US, CA, ALT. See also <i>VHF channel table</i> on page 19.</p> <p>Below CHANNEL MODE all the channel tables are listed</p>
CALL CHANNEL	<p>The call channel for the selected channel table is displayed and can be changed at the top of each channel table.</p> <p>Select the channel you want to use as a programmed call channel. This channel is used as one channel in triple watch and when you tap and hold the 16/C button.</p>
INT. CHANNELS BI. CHANNELS US. CHANNELS CA. CHANNELS 	<p>You can view and change the settings for each channel (change is password protected). Tap a channel to access the properties for the channel. See the table on the next page for accessible properties for each channel table.</p> <p>Tap  to return to CHANNELS.</p> 
ALT. CHANNELS	As described above, plus add or delete channels.
PRIVATE CHANNELS	As described above, plus add or delete channels.
AUX OUTPUT	<p>Configuration of the AUX port:</p> <p>MODE: OFF (default), Squelch Open, On Channel</p> <p>CHANNEL: Shows selected channel for AUX</p>

Editable properties for the channels in each channel table:

Property	INT	BI	CA	US	ALT	Private
DESIGNATOR					x	x
NAME	x	x	x	x	x	x
25 W ALLOWED	x		x	x	x	x
TX BLOCK	x	x	x	x	x	x
ATIS	x	x	x	x	x	x
AUX	x	x	x	x	x	x
PROPOSE FOR DSC	x	x	x	x	x	x
RX FREQUENCY					x	x
TX FREQUENCY					x	x
AVAILABILITY						x
Add or delete channel					x	x

DSC

Parameter	Description
MMSI 	The MMSI of the radio. 9 digit numerical (Default: Not set, password protected if set). See the installation manual for a step-by-step description.
GROUPS	Shows DSC groups. You can add, edit and delete groups here. Each entry in a group consists of MMSI, name and enabled/disabled.
POSITION	<ul style="list-style-type: none"> • SOURCE: GNSS (default) or MANUAL • GNSS INPUT PORT: <ul style="list-style-type: none"> • AUTOMATIC: Automatically select position source with the best quality. In Automatic mode the position device transmitting sentences with the best quality indicator will be used as position source. • NMEA: NMEA 1 position input • NMEA HS: NMEA 2 position input • LWE1: Specific LWE position input (see LWE Talkers below) • LWE2: Specific LWE position input (see LWE Talkers below) • LWE3: Specific LWE position input (see LWE Talkers below) • INM-C: SAILOR Inmarsat C position input • CURRENT AUTOMATIC GNSS INPUT (if GNSS INPUT PORT is AUTOMATIC): NMEA, NMEA HS, LWE1, LWE2, LWE3 or INM-C (read only) • CURRENT POSITION (editable if source is MANUAL): <ul style="list-style-type: none"> • LATITUDE • LONGITUDE • UTC TIME • LWE1: AUTO or specific Talker ID • LWE2: AUTO or specific Talker ID • LWE3: AUTO or specific Talker ID



Parameter	Description
AUTO-ACK	Auto-acknowledgment: <ul style="list-style-type: none"> • Test: Auto-acknowledgment of test DSC messages. Disabled or Enabled (default) • Poll: Auto-acknowledgment of polling DSC messages. Disabled or Enabled (default) • Position: Auto-acknowledgment of position DSC messages. Disabled (default) or Enabled • Individual: Auto acknowledgment of individually addressed, non distress DSC messages with channel unavailable for communication. Disabled or Enabled (default)
NON-DISTRESS INACTIVITY	Inactivity time-out to exit non-distress functions (e.g. in setup) without automatic time-out: Range: OFF, 1 to 30 minutes, in 1 min. steps Default: 15min.
DISTRESS INACTIVITY	Inactivity time-out for received distress DSC automated procedures without automatic time-out: Range: OFF, 1 to 30 minutes, in 1 min. steps Default: OFF
COMM INACTIVITY	Inactivity time-out of non DSC communication (VHF). Range: 10 to 600 seconds, in 10 second steps Default: 30sec
NON-DISTRESS SOUND	Sound at non-distress DSC alarms: <ul style="list-style-type: none"> • OFF: Sound disabled • Single ring: Sound only once (default) • Repeated ring: Repeat sound cyclic
MEDICAL TRANSPORT	<ul style="list-style-type: none"> • ON: This option is available in DSC calls of the type Urgency. • OFF (default)

Parameter	Description
NEUTRAL CRAFTS	<ul style="list-style-type: none"> • ON: This option is available in DSC calls of the type Urgency. • OFF (default)
AUTO CHANNEL SWITCH	<ul style="list-style-type: none"> • OFF: Automatic channel switching is disabled, icon LCK will be visible in stand-by mode. • ON: Automatic channel switching is enabled (default)
PRINT DSC	For printing of DSC messages on a printer connected to the system. <ul style="list-style-type: none"> • ON or • OFF (default)

POWER SUPPLY

Parameter	Description
MONITOR	Set this to ENABLED if the radio is connected to a TT-6081A Power Supply and Charger. Set this to DISABLED (default) for any other power supply.
STATUS	If MONITOR enabled: Current status of the connected power supply.
VOLTAGE	If MONITOR enabled: Current voltage.
CURRENT	If MONITOR enabled: Current current.

NMEA

Parameter	Description
LWE TALKER 	CVnnnn, default: Random generated ID Use the on-screen keypad to type in the correct ID (typically done during installation)
BRIDGE ALERT MANAGEMENT (BAM) 	<ul style="list-style-type: none"> • LWE: ON (default) or OFF • Multicast group (if LWE=ON): BAM1 (default), BAM2, RCOM or USR1-8 • Cluster: NAV or COM (default) • OPT: ON or OFF (default)





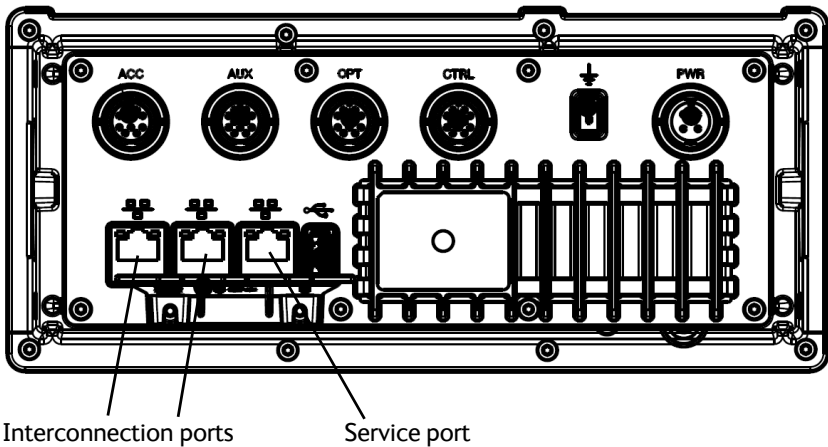

NETWORK

There are 3 LAN connectors on the Control Unit. The LAN connector closest to the USB connector is the Service port, e.g. used for accessing the settings of the Control Unit and for connection to an external network, the two leftmost LAN connectors are for connecting other units in a local network.



Parameter	Description
SERVICE PORT 	Configuration of the Service port (LAN connector) <ul style="list-style-type: none"> IP Mode: <ul style="list-style-type: none"> DHCP Client (default) or Static IP address (only editable if Static is selected) Netmask (only editable if Static is selected) Gateway (only editable if Static is selected)
INTER-CONNECTION PORTS	<ul style="list-style-type: none"> IP address (Read only) Netmask (Read only) Gateway (Read only) If a DHCP server is not available, the interconnection ports automatically use zeroconf to obtain an IP address.

SYSTEM

Parameter	Description
SOFTWARE UPDATE 	<ul style="list-style-type: none"> • USB Mass Storage: Select a tiif file from a connected USB device. • Upload: Select a tiif file from a connected PC.
PAIRING 	<p>If not paired:</p> <p>Opens a list of all nearby transceiver units (TU) with</p> <ul style="list-style-type: none"> • Serial number • pairing status (paired to another control unit (CU) or not) • SW version • Pairing button for pairing the CU to the TU <p>If paired:</p> <p>Shows information on the TU that the CU is paired to:</p> <ul style="list-style-type: none"> • Serial number • SW version and SW version compatibility • Unpair button for unpairing the TU from the CU
FACTORY RESET 	<p>Resets the radio to factory defaults.</p> <p>Tap OK to confirm.</p>
SAVE CONFIGURATION 	<ul style="list-style-type: none"> • USB Mass Storage: Save the configuration to a connected USB device. • Download: Save the configuration to a connected PC.
LOAD CONFIGURATION 	<ul style="list-style-type: none"> • USB Mass Storage: Select a configuration file from a connected USB device. • Upload: Select a configuration file from a connected PC.
CHANGE PASSWORD 	<p>Change the password for accessing password-protected parts of the user interface.</p>

Parameter	Description
PRINTER	Select a printer (if one or several printers are part of the system). Note whether there is immediate print upon DSC activity, You must set Print DSC to ON see <i>DSC</i> on page 44. Recommended commercially available printer-servers: SAILOR 6004 Control Panel
INACTIVITY TIMEOUT	Inactivity time-out to exit functions (e.g. in Settings) and return to the application. Range: 1 to 30 minutes, in 1 minute steps Default: 10 min.
THEME	Changes the display color: <ul style="list-style-type: none"> • Light (default) • Dark • Cobham • Night
REBOOT	Reboots the VHF radio

REMOTE CONTROL

When you activate Remote control, you can access the graphical user interface from any unit with a browser installed.

Note

If you access any of the controls on the physical Control Unit while remote control is used, the remote control is deactivated and you have to activate it again to be able to use it.

Parameter	Description
ACTIVATE	Opens the API and GUI for access through external LAN ports. A popup shows connection status and a button for deactivating.

To connect to the Control Unit after activating, do as follows:

1. Connect your device to one of the LAN connectors on the SAILOR 7224 Control Unit
2. Open your browser and type `http://<CU IP>`, where <CU IP> is the IP address of the Control Unit.

The web interface now opens and lets you control the system from your connected device instead of on the Control Unit display.

ABOUT

Parameter	Description (read only)
CONTROL UNIT	<ul style="list-style-type: none"> • Serial number • Hardware Tracking Number • Software version
TRANSCEIVER UNIT	<ul style="list-style-type: none"> • Serial number • Hardware Tracking Number • Software version
APPROVALS	List of approvals, e.g. FCC
LICENSES	List of licenses, e.g. GPL

Service & maintenance

Contact for support

Contact your authorized dealer for technical service and support of the VHF radio. Before contacting your authorized dealer you can go through the troubleshooting guide to solve some of the most common operational problems.

Maintenance

Preventive maintenance

Maintenance of the SAILOR 7222 VHF DSC can be reduced to a maintenance check at each visit of the service staff. Inspect the radio (Control Unit and Transceiver) for mechanical damages, salt deposits, corrosion and any foreign material. Due to its robust construction and ruggedness the radio has a long lifetime. Anyway it must carefully be checked at intervals not longer than 12 months - dependent on the current working conditions.

DSC self test

To run a control routine DSC self test, do as follows:

1. Tap **DSC TEST** from the idle screen (Home) or, if you are in a DSC session, tap **MORE** and then **DSC TEST**.

The test will check the ability to encode/decode DSC signaling on RF level. The radio will automatically transmit a DSC safety test call to its own MMSI number without enabling the transmitter power amplifier. In parallel the radio decodes and compares the received call to be the same as the transmitted. The display shows the result of the test.

2. Tap **OK** to acknowledge the test result and resume normal operation.

Important

If the DSC loopback test fails, this indicates the DSC functionality does not work correctly — including the ability to send a distress message.

Contact your dealer immediately for further advice.

Disposal

Old electrical and electronic equipment marked with this symbol can contain substances hazardous to human beings and the environment. Never dispose these items together with unsorted municipal waste (household waste). In order to protect the environment and ensure the correct recycling of old equipment as well as the re-utilization of individual components, use either public collection or private collection by the local distributor of old electrical and electronic equipment marked with this symbol.



Contact the local distributor for information about what type of return system to use.

Status signaling

Information of alerts

Errors and warning messages are shown in the display and are read-only.

List of alert icons



Warning: Active acknowledged alert



Caution: Alert



Warning: Active transferred alert



Warning: Active unacknowledged alert, silent



Warning: Active unacknowledged alert



Status OK, no active alerts



Warning: Inactive unacknowledged alert, rectified

List of alerts

The table below shows the alerts you may see in the Bridge Alert Management (BAM) system.

ID	Instance	Priority	Category	Title	Description
3023	1	C	B	PS COMM Lost	Power supply communication lost
3023	2	C	B	BATT VOLT Low	Battery and charger. Voltage below limit
3023	3	C	B	BATT VOLT High	Battery and charger. Voltage above limit
3078	1	W	B	Printer Status	No connection to printer
3016	1	C	B	SAR-POSITION LOST	No position available
3016	2	C	B	SAR-POSITION LOST	No position available for 10 minutes
3013	1	C	B	POSN 4hrs Old	Position more than 4 hrs old
3013	2	C	B	POSN 23,5hrs Old	Position more than 23,5 hrs old
3122	Dynamic ^a	W	B	DISTRESS: RX	Incoming distress
3122	Dynamic ^a	W	B	DISTRESS: RELAY	Incoming distress relay
3122	Dynamic ^a	W	B	URGENCY: RX	Incoming urgency call
3123	Dynamic ^a	C	B	SAFETY: COM	Incoming safety call
3123	Dynamic ^a	C	B	SAFETY: POS	Incoming safety pos. call
3123	Dynamic ^a	C	B	SAFETY: TEST	Incoming safety test call
3123	Dynamic ^a	C	B	ROUTINE: COM	Incoming routine call
3123	Dynamic ^a	C	B	ROUTINE: POLL	Incoming routine poll
3123	Dynamic ^a	c	B	GROUP: RX	Incoming group call
3008	1	w	B	TX POWER:INHIBIT	Transmission inhibited
	1	w	B	TU Conn Lost	TU connection lost. Verify connection

Table 4: List of alerts

- a. Alert instance is assigned according to IEC61162-1:2016, 8.3.13, 9).

All warnings are repeated as warnings for each 4 minutes, i.e. silent period will maximum be 4 minutes. Responsibility transfer can only occur for warning alert in BAM Category “B” and only via incoming NMEA command from e.g. a CAM.

Replacing the fuse in the Transceiver Unit

One fuse is installed in the Transceiver Unit. If the fuse is blown, do as follows:

1. Track down why the fuse was blown and solve the problem.
2. Take out the old fuse.
3. Insert the new fuse. The fuse rating is 10 A T.



Figure 3: Replacing the fuse in the SAILOR 7226 VHF Transceiver Unit

Warranty and returning units for repair

Should your Cobham SATCOM product fail, contact your dealer or installer, or the nearest Cobham SATCOM partner. You will find the partner details on www.cobhamsatcom.com/where-to-buy. You can also access www.cobhamsatcom.com and select **COBHAM SYNC PARTNER PORTAL**, which may help you solve the problem. Your dealer, installer or Cobham SATCOM partner will assist you whether the need is user training, technical support, arranging on-site repair or sending the product for repair. Your dealer, installer or Cobham SATCOM partner will also take care of any warranty issue.

Repacking for shipment

Should you need to send the product for repair, please read the below information before packing the product.

The shipping carton has been carefully designed to protect the SAILOR 7222 VHF DSC and its accessories during shipment. This carton and its associated packing material should be used when repacking for shipment. Attach a tag indicating the type of service required, return address, part number and full serial number. Mark the carton FRAGILE to ensure careful handling.

Note

Correct shipment is the customer's own responsibility.

If the original shipping carton is not available, the following general instructions should be used for repacking with commercially available material.

1. Wrap the defective unit in heavy paper or plastic. Attach a tag indicating the type of service required, return address, part number and full serial number.
2. Use a strong shipping container, e.g. a double walled carton.
3. Protect the front- and rear panel with cardboard and insert a layer of shock-absorbing material between all surfaces of the equipment and the sides of the container.
4. Seal the shipping container securely.
5. Mark the shipping container FRAGILE to ensure careful handling.

Failure to do so may invalidate the warranty.

Specifications

SAILOR 7226 VHF Transceiver Unit

Item	Specification
Weight	1.5 kg (3.3 lbs)
Dimensions	Height: Outer dimension 161 mm Width: Outer dimension 306 mm Depth: Outer dimension 51 mm
Operating temperature	-15°C to 55°C (5°F to 131°F)
Storage temperature	-25°C to 70°C (-13°F to 158°F)
Ingress Protection	IP20
Power supply	24 VDC +30%/-10%
Power consumption (typical)	Rx operative: 8 W Tx 25 W operative: 65 W Tx 1 W operative: 18 W
Heat dissipation (typical)	Rx operative: 8 W Tx 25 W operative: 40 W Tx 1 W operative: 17 W
RX/TX ant. Input/output	50 ohm @ TX voice/TX DSC & RX voice
DSC ant. Input	50 ohm @ RX DSC
LAN	2 LAN ports Category 6 STP

Item	Specification
Frequency range	Voice: 156.000 MHz — 164.000 MHz DSC: 156.525 MHz
Channel spacing	25 kHz, all international maritime channels
Number of P channels	The radio may be programmed with up to 100 private channels in all channel modes.
Modulation	16K0G3E, 16K0G2B (DSC)
Transmitter	
RF output power	High: 25 W +0 dB / - 1.5 dB Low: 1 W +0 dB / - 1.5 dB
Frequency error	+/- 3ppm
Adjacent channel power	Below 80 dB
Conducted spurious emission	Below 0.25 mW
Distortion	Below 3%
S/N ratio	Better than 46 dB
Receiver @ voice	
Sensitivity	< -119 dBm typically @ 20 dB SINAD CCITT weighted
LF power	Built-in loudspeaker: 6 W (at 5 kHz dev./1 kHz tone) External loudspeaker: 6 W / 8 Ohm
Distortion	Below 5%
Spurious emissions	Below 2 nW
Spurious response rejection	80 dB

Item	Specification
Intermodulation response	76 dB
Co-channel rejection	Better than -10 dB
Adjacent channel selectivity	80 dB
Blocking response	Better than 100 dB μ V @ \pm 1 MHz
Receiver @ DSC	
Sensitivity	-117 dBm
Adjacent channel selectivity	Below 80 dB
Intermodulation response	Better than 70 dB μ V
Blocking response	Better than 100 dB μ V

SAILOR 7224 Control Unit

Item	Specification
Weight	1.0 kg (2.2 lbs)
Dimensions	Height: Outer dimension 107 mm, hole height for flush mount 89 mm Width: Outer dimension 241 mm, hole width for flush mount 227 mm Depth: Outer dimension from front of knobs 104 mm, depth for flush mount 94 mm
Operating temperature	-15°C to 55°C (5°F to 131°F)
Storage temperature	-25°C to 70°C (-13°F to 158°F)

Item	Specification
Ingress Protection	IP54 when flush-mounted (Estimated, only front exposed) IP20 for other installation (whole unit exposed)
Power supply	+24 V DC nom. (-10% / +30%)
Power consumption	10 W @ 24 VDC standby 33 W @ 24 VDC max
Heat dissipation	8.5 to 15 W
Display	5.5" TFT with capacitive multi touch – 350 cd/m2. (e.g. 800x600, 1024x768) – 40k hours to half brightness
Speaker	Internal speaker – Max audio output power: 6W (internal LS @ 5 kHz deviation/1kHz)
LAN	2 LAN ports supporting RSTP and 10/100 Mbit 1 LAN port not supporting RSTP
USB	USB 2.0
CTRL Port	Supporting up to four SAILOR 6204
ACC Port	Supporting Handset & Hand Microphone. NMEA for GNSS and AIS
AUX Port	Support for VDR, Alarm I/O, GNSS, AUX OC and Ext. Speaker. Max audio output power: 6W (external LS @ 5 kHz deviation/1kHz)
OPT Port	Supporting NMEA RX and TX for BAM support

General DSC specifications

Item	Description
DSC operation	According to: - ITU-R M.493.15 - ETSI EN 300 338-1 - ETSI EN 300 338-2
DSC protocol	According to Rec. ITU-R M.493-13 - Class A, IEC 61097-3 and IEC 61097-8
Navigator interface	According to IEC 61162-1 GLL, RMC, ZDA, GGA, VTG, GNS
Modulation	1700 Hz \pm 400 Hz. 1200 baud

Maritime channels

International channels (INT)

Channels	TX MHz	RX MHz	SIMPLEX		DUPLEX			
			Intership	Port	Port	Public		
1	156,050	160,850			●	●		
2	156,100	160,700			●	●		
3	156,150	160,750			●	●		
4	156,200	160,800			●	●		
5	156,250	160,850			●	●		
6	156,300	156,300	●					
7	156,350	160,950			●	●		
8	156,400	156,400	●					
9	156,450	156,450	●	●				
10	156,500	156,500	●	●				
11	156,550	156,550	●	●				
12	156,600	156,600	●	●				
13	156,650	156,650	●	●				
14	156,700	156,700	●	●				
15	156,750	156,750	●	●				
16	156,800	156,800	Distress and calling					
17	156,850	156,850	●	●				
18	156,900	161,500			●	●		
19	156,950	161,550			●	●		
1019 ***	156,950	156,950						
2019 ***		161,550	● RX					
20	157,000	161,600			●	●		
1020 ***	157,000	157,000	●	●				
2020 ***		161,600	● RX					
21 **	157,050	161,650						
22 **	157,100	161,700						
23 **	157,150	161,750						
24 **	157,200	161,800						
25 **	157,250	161,850						
26 **	157,300	161,900						
27	157,350	161,950			●	●		
1027 ***	157,350	157,350	●	●				
28	157,400	162,000			●	●		
1028 ***	157,400	157,400	●	●				

Channels	TX MHz	RX MHz	SIMPLEX		DUPLEX	
			Intership	Port	Port	Public
60	156,025	160,825			●	●
61	156,075	160,875			●	●
62	156,125	160,725			●	●
63	156,175	160,775			●	●
64	156,225	160,825			●	●
65	156,275	160,875			●	●
66	156,325	160,925			●	●
67	156,375	156,375	●	●		
68	156,425	156,425			●	
69	156,475	156,475	●	●		
70	156,525	156,525	DSC	DSC		
71	156,575	156,575			●	
72	156,625	156,625	●	●		
73	156,675	156,675			●	
74	156,725	156,725			●	
75	156,775	156,775			● L	
76	156,825	156,825			● L	
77	156,875	156,875	●	●		
78	156,925	161,525			●	●
1078 ***	156,925	156,925				
2078 ***		161,525	● RX			
79	156,975	161,575			●	●
1079 ***	156,975	156,975	●	●		
2079 ***		161,575	● RX			
80 **	157,025	161,625				
81 **	157,075	161,675				
82 **	157,125	161,725				
83 **	157,175	161,775				
84 **	157,225	161,825				
85 **	157,275	161,875				
86 **	157,325	161,925				
87	157,375	157,375			● *)	
88	157,425	157,425			● *)	

L) 1 W TX power

RX) Only RX: Transmission is blocked.

*) Channel 87 and 88 became simplex channels following the introduction of AIS1 at 161.975 MHz and AIS2 on 162.025 MHz.

***) According to Radio Regulations Final Acts WRC-15 Appendix 18 these channels are repurposed and must be default disabled as of January 1st 2017.

****) According to Radio Regulations Final Acts WRC-15 Appendix 18 these channels must be default enabled as of January 1st 2017.

These are the default channels. Additional narrowband channels can be enabled, see CHANNELS on page 42

US channels (US)

Channels	TX MHz	RX MHz	SIMPLEX	DUPLEX
1A	156,050	156,050	●	
2				B)
3				B)
4				B)
5A	156,250	156,250	●	
6	156,300	156,300	●	
7A	156,350	156,350	●	
8	156,400	156,400	●	
9	156,450	156,450	●	
10	156,500	156,500	●	
11	156,550	156,550	●	
12	156,600	156,600	●	
13	156,650	156,650	● L)	
14	156,700	156,700	● RX)	
15		156,750	● RX)	
16	156,800	156,800	Distress and calling	
17	156,850	156,850	●	
18A	156,900	156,900	●	
19A	156,950	156,950	●	
20	157,000	161,600		●
20A	157,000	157,000	●	
21A	157,050	157,050	● I)	
22A	157,100	157,100	● I)	
23A	157,150	157,150	● I)	
24	157,200	161,800		●
25	157,250	161,850		●
26	157,300	161,900		●
27	157,350	161,950		●
28	157,400	162,000		●

Channels	TX MHz	RX MHz	SIMPLEX	DUPLEX
60				B)
61				B)
62				B)
63A	156,175	156,175	●	
64				B)
65A	156,275	156,275	●	
66A	156,325	156,325	●	
67	156,375	156,375	● L)	
68	156,425	156,425	●	
69	156,475	156,475	●	
70	156,525	156,525	DSC	
71	156,575	156,575	● L)	
72	156,625	156,625	●	
73	156,675	156,675	●	
74	156,725	156,725	●	
75				B)
76				B)
77	156,875	156,875	●	
78A	156,925	156,925	●	
79A	156,975	156,975	●	
80A	157,025	157,025	●	
81A	157,075	157,075	● I)	
82A	157,125	157,125	● I)	
83A	157,175	157,175	● I)	
84	157,225	161,825		●
85	157,275	161,875		●
86	157,325	161,925		●
87A	157,375	157,375	● *)	
88A	157,425	157,425	● *)	

Channels	RX MHz
W1	162,550
W2	162,400
W3	162,475
W4	162,425
W5	162,450
W6	162,500
W7	162,525

- L) 1 W TX power. Channels 13, 67 and 71 are limited to low transmission power.
- B) Channels 2, 3, 4, 60, 61, 62, 64, 75 and 76 cannot be selected in US mode.
- I) Channels 21A, 22A, 23A, 81A, 82A and 83A may be legally used in some circumstances but not by the general public in US waters.
- RX) Only RX: transmissions are blocked.
- *) Channels 87 and 88 became simplex channels following the introduction of AIS1 at 161.975 MHz and AIS2 on 162.025 MHz.

These are the default channels. Additional narrowband channels can be enabled, see CHANNELS on page 42.

Canadian channels (CA)

Channels	TX MHz	RX MHz	SIMPLEX	DUPLEX
1	156,050	160,650		●
2	156,100	160,700		●
3	156,150	160,750		●
4A	156,200	156,200	● J)	
5A	156,250	156,250	●	
6	156,300	156,300	● J)	
7A	156,350	156,350	●	
8	156,400	156,400	●	
9	156,450	156,450	●	
10	156,500	156,500	●	
11	156,550	156,550	●	
12	156,600	156,600	●	
13	156,650	156,650	●	
14	156,700	156,700	●	
15	156,750	156,750	● L)	
16	156,800	156,800	Distress and calling	
17	156,850	156,850	● L)	
18A	156,900	156,900	●	
19A	156,950	156,950	● J)	
20	157,000	161,600		● L)
21A	157,050	157,050	● J)	
21B		161,650	● RX)	
22A	157,100	157,100	● J)	
23	157,150	161,750		●
24	157,200	161,800		●
25	157,250	161,850		●
26	157,300	161,900		●
27	157,350	161,950		●
28	157,400	162,000		●

Channels	TX MHz	RX MHz	SIMPLEX	DUPLEX
60	156,025	160,625		●
61A	156,075	156,075	● J)	
62A	156,125	156,125	● J)	
63A	156,175	156,175	● J)	
64	156,225	160,225		●
64A	156,225	156,225	●	
65A	156,275	156,275	● L)	
66A	156,325	156,325	● L)	
67	156,375	156,375	● J)	
68	156,425	156,425	●	
69	156,475	156,475	●	
70	156,525	156,525	DSC	
71	156,575	156,575	●	
72	156,625	156,625	● J)	
73	156,675	156,675	● J)	
74	156,725	156,725	●	
75	156,775	156,775	● L)	
76	156,825	156,825	● L)	
77	156,875	156,875	● L)	
78A	156,925	156,925	●	
79A	156,975	156,975	●	
80A	157,025	157,025	●	
81A	157,075	157,075	● J)	
82A	157,125	157,125	● J)	
83A	157,175	157,175	● J)	
83B		161,775	● RX)	
84	157,225	161,825		●
85	157,275	161,875		●
86	157,325	161,925		●
87	157,375	157,375	● *)	
88	157,425	157,425	● *)	

Channels	RX MHz
W1	162,550
W2	162,400
W3	162,475
W4	162,425
W5	162,450
W6	162,500
W7	162,525

- L) 1 W TX power. Channels 15, 17, 20, 65, 66, 75, 76 and 77 are limited to 1 W transmission power.
- J) Channels 4A, 6, 19A, 21A, 22A, 61A, 62A, 63A, 67, 72, 73, 81A, 82A and 83A may be legally used in some circumstances but not by the general public in CA waters.
- RX) Only RX: transmission is blocked.
- *) Channels 87 and 88 became simplex channels following the introduction of AIS1 at 161.975 MHz and AIS2 on 162.025 MHz.

These are the default channels. Additional narrowband channels can be enabled, see *CHANNELS* on page 42.

Binnenwasser channels (BI)

Channels	TX MHz	RX MHz	SIMPLEX		DUPLEX	
			Intership	Port	Port	Public
1	156.050	160.650			●	●
2	156.100	160.700			●	●
3	156.150	160.750			●	●
4	156.200	160.800			●	●
5	156.250	160.850			●	●
6	156.300	156.300	● L)		●	●
7	156.350	160.950			●	●
8	156.400	156.400	● L)			
9	156.450	156.450		●		
10	156.500	156.500	● L)	● L)		
11	156.550	156.550		● L)		
12	156.600	156.600		● L)		
13	156.650	156.650	● L)	● L)		
14	156.700	156.700		● L)		
15	156.750	156.750	● L)	● L)		
16	156.800	156.800	Distress and calling			
17	156.850	156.850				
18	156.900	161.500	● L)	● L)	●	●
19	156.950	161.550			●	●
1019 ***)	156.950	156.950		●		●
2019 ***)		161.550		●RX)		
20	157.000	161.600			●	●
1020 ***)	157.000	157.000				
2020 ***)		161.600		●RX)		
21 **)	157.050	161.650				
22 **)	157.100	161.700				
23 **)	157.150	161.750				
24 **)	157.200	161.800				
25 **)	157.250	161.850				
26 **)	157.300	161.900				
27	157.350	161.950			●	●
1027 ***)	157.350	157.350		●		
28	157.400	162.000			●	●
1028 ***)	157.400	157.400		●		

Channels	TX MHz	RX MHz	SIMPLEX		DUPLEX	
			Intership	Port	Port	Public
60	156.025	160.625			●	●
61	156.075	160.675			●	●
62	156.125	160.725			●	●
63	156.175	160.775			●	●
64	156.225	160.825			●	●
65	156.275	160.875			●	●
66	156.325	160.925			●	●
67	156.375	156.375	●	●		
68	156.425	156.425		●		
69	156.475	156.475	●	●		
70	156.525	156.525	DSC	DSC		
71	156.575	156.575		● L)		
72	156.625	156.625	● L)			
73	156.675	156.675	●	●		
74	156.725	156.725		● L)		
75	156.775	156.775		● L)		
76	156.825	156.825		● L)		
77	156.875	156.875	● L)			
78	156.925	161.525			●	●
1078 ***)	156.925	156.925		●		
2078 ***)		161.525		●RX)		
79	156.975	161.575			●	●
1079 ***)	156.975	156.975				
2079 ***)		161.575		●RX)		
80 **)	157.025	161.625				
81 **)	157.075	161.675				
82 **)	157.125	161.725				
83 **)	157.175	161.775				
84 **)	157.225	161.825				
85 **)	157.275	161.875				
86 **)	157.325	161.925				
87	157.375	157.375		● *)		
88	157.425	157.425		● *)		

L) 1 W TX power on channels 6, 8, 10, 11, 12, 13, 14, 15, 17, 71, 72, 74, 75, 76 and 77.

RX) Only RX) Transmission is blocked.

*) Channels 87 and 88 became simplex channels following the introduction of AIS1 at 161.975 MHz and AIS2 on 162.025 MHz.

**) According to Radio Regulations Final Acts WRC-15 Appendix 18 these channels are repurposed and must be default disabled as of January 1st 2017.

***) According to Radio Regulations Final Acts WRC-15 Appendix 18 these channels must be default enabled as of January 1st 2017.

NB) The ATIS function is enabled on all channels.
Dual Watch & Scanning modes are disabled.

Alternative channels (ALT)

If the radio is used in regions where neither of the four described standard channels are allowed, an alternative channel table with international channel designators and frequencies can be made. Contact your local dealer for programming or alteration of the alternative channels.

The following table lists the default programmed alternative channels (RR18 before WRC15)

Channels	TX MHz	RX MHz	SIMPLEX		DUPLEX		
			Intership	Port	Port	Public	
1	156,050	160,650			●	●	
2	156,100	160,700			●	●	
3	156,150	160,750			●	●	
4	156,200	160,800			●	●	
5	156,250	160,850			●	●	
6	156,300	156,300	●				
7	156,350	160,950			●	●	
8	156,400	156,400	●				
9	156,450	156,450	●	●			
10	156,500	156,500	●	●			
11	156,550	156,550		●			
12	156,600	156,600		●			
13	156,650	156,650	●	●			
14	156,700	156,700		●			
15	156,750	156,750	●	●			
16	156,800	156,800	Distress and calling				
17	156,850	156,850	●	●			
18	156,900	161,500			●	●	
19	156,950	161,550			●	●	
20	157,000	161,600			●	●	
21	157,050	161,650			●	●	
22	157,100	161,700			●	●	
23	157,150	161,750			●	●	
24	157,200	161,800			●	●	
25	157,250	161,850			●	●	
26	157,300	161,900			●	●	
27	157,350	161,950			●	●	
28	157,400	162,000			●	●	

Channels	TX MHz	RX MHz	SIMPLEX		DUPLEX	
			Intership	Port	Port	Public
60	156,025	160,625			●	●
61	156,075	160,675			●	●
62	156,125	160,725			●	●
63	156,175	160,775			●	●
64	156,225	160,825			●	●
65	156,275	160,875			●	●
66	156,325	160,925			●	●
67	156,375	156,375	●	●		
68	156,425	156,425		●		
69	156,475	156,475		●		
70	156,525	156,525	DSC	DSC		
71	156,575	156,575		●		
72	156,625	156,625	●			
73	156,675	156,675		●		
74	156,725	156,725		●		
75	156,775	156,775		● L)		
76	156,825	156,825		● L)		
77	156,875	156,875	●			
78	156,925	161,525			●	●
79	156,975	161,575			●	●
80	157,025	161,625			●	●
81	157,075	161,675			●	●
82	157,125	161,725			●	●
83	157,175	161,775			●	●
84	157,225	161,825			●	●
85	157,275	161,875			●	●
86	157,325	161,925			●	●
87	157,375	157,375		● *)		
88	157,425	157,425		● *)		

L) 1 W TX power

*) Channel 87 and 88 became simplex channels following the introduction of AIS1 at 161.975 MHz and AIS2 on 162.025 MHz.

Private channels (P)

Up to 100 licensed private channels for non-DSC purposes may be specified. For programming the private channels contact your local dealer.

A

AIS Automatic Identification System, a short range coastal tracking system used on ships and by Vessel Traffic Services for identifying and locating vessels by electronically exchanging data with other nearby ships.

API Application Programming Interface

ATIS Automatic Transmission Identification System

B

BAM Bridge Alert Management (BAM) is a concept, defined by the IMO, for the management, handling and harmonized presentation of alerts on the bridge.

C

CAM Central Alert Management

CAN Controller-Area Network.

CSM Control Speaker Microphone

CU Control Unit

D

DHCP Dynamic Host Configuration Protocol.

DROBOSE Distress Relay On Behalf Of Someone Else

DSC Digital Selective Calling

E

EPIRB Emergency Position-Indicating Radio Beacon. Distress radio beacons, also known as emergency beacons are tracking transmitters which aid in the detection and location of boats, aircraft, and people in distress.

F

FCC OET FCC Office of Engineering and Technology

Glossary

FCC Federal Communications Commission

G

GNSS Global Navigation Satellite System

GPL General Public License, Software license, which guarantees individuals, organizations and companies the freedom to use, study, share (copy), and modify the software.

GUI Graphical User Interface

I

IMO International Maritime Organization

L

LAN Local Area Network

LGPL Lesser General Public License

LWE Light Weight Ethernet

M

MOB Man Over Board

N

NMEA National Marine Electronics Association

P

PTT Push To Talk

R

RAINWAT Regional Arrangement Concerning the Radiotelephone Service on Inland Waterways

RF Radio Frequency

T

TFT display Thin Film Transistor display

TU Transceiver Unit

U

USB Universal Serial Bus.

UTC Universal Time, Coordinated

V

VDR Voyage Data Recorder

VHF Very High Frequency

Z

Zeroconf Zeroconf is a set of technologies that automatically creates a usable computer network based on the Internet Protocol Suite (TCP/IP) when computers or network peripherals are interconnected.

Numerics

16/C, 11, 17

A

acknowledgment, distress, 30

activate

scan resume, 40

scanning, 21

watch, 20

adjust

speaker volume, 10

squelch, 15

Alarm Panel

manual, x

alarm panel

Distress, 31

ALERT, 29

ALT channels, 69

alternative channels, 69

ATIS code, 40

attenuation control, 20

Auto-Acknowledge, 45

automatic channel switch, 46

B

background sessions

DSC, 37

backlight, 1

dim, 11

Bi channel table, 68

browse channels, 11

C

CA channels, 67

call

distress procedure, vi

DSC, 22

call channel, 18

programming, 42

canceling

distress, 30

change

dual and triple watch, 20

channel

add to scan, 21

remove from scan, 21

select, 11

working, 11

channel selector knob, 2, 11

channel setup, 42

channel table

ALT, 69

Bi, 68

CA, 67

INT, 65

US, 66

channels

Bi, 68

CA, 67

international, 65

primary, 19

private, 19

US, 66

weather, 19

Color theme, 50

Comm Inactivity, 45

configuration

system example, 7

contact, 53

control over radio transmitter, 22

Control Speaker Microphone
 override, 16
controls, front plate, 2

D

deactivate
 watch, 20
default reset, 49
dim, 11
display, 3
display color
 change, 50
distress
 acknowledgment, 30
 canceling, 30
 display, 28
 message relay, 32
 nature, 28
 power failure, 30
 received calls, 33
 send from alarm panel, 31
 time since activation, 28
distress alert, 29
distress button, 28
distress channel, 11, 15, 17
distress procedure, vi
distress timeout, 45
document number, this manual, i
DROBOSE, 14, 32
DSC
 background sessions, 37
 call log, 33
 calls, 22
 loopback test, 53
 multiple calls, 37
 session definition, 25
DSC alarms
 non distress, 45
DSC keys, 25
DSC session, 22

DSC window, 22
dual watch
 change to triple, 20

E

Emergency call sheet, x
emergency calls, vi
engagement status, 19
enter position manually, 12
EPIRB
 nature in DROBOSE, 32
error messages, 55, 56

F

factory defaults, 49
FILTER, 21
frequency range, VHF, 60
front plate, controls, 2

H

Hand Microphone, 11
hang time, 40

I

installation guide, A3, x
installation manual, x
 Alarm Panel, x
INT channel table, 65
IP rating, 59

K

key
 16/C, 11, 17
 DROBOSE, 14, 32
 DSC, 25
keys on front plate, 2
knob
 channel selector, 2
 volume and squelch, 2

L

- louder, volume, 10
- low power
 - set to 1 W, 20

M

- manual, document number, i
- maritime channels, 65
- MAYDAY, vi
- medical transport, 45
- message
 - replay, 37
- monitor power supply, 46
- multiple calls, DSC, 37
- mute speaker, 15

N

- nature of distress, 28
- neutral crafts, 46
- night vision, how to dim, 11
- Non-dist Inactivity, 45
- Non-distr.alarms, 45

O

- Occupied, 16
- override
 - Control Speaker Microphone, 16

P

- position data
 - enter manually, 12
- position Info, 44
- power failure
 - distress, 30
- power supply
 - monitor, 46
- Print DSC, 46
- priority scan, 40

- private channels, 19, 60, 69
- PTT button, 17

R

- radio call
 - making, 18
 - receiving, 17
- radio transmitter
 - control, 27
 - control over, 22
- received distress calls, 33
- reduced transmission power, 20
- relay
 - distress message on behalf of someone else, 32
- remote control, 16
- replay, 1, 37
- reset to default, 49
- resume time, 40
- RF exposure hazards, iv

S

- safety summary, iv
- salt deposits, 53
- scan
 - add channel, 21
 - hang time, 40
 - priority, 40
 - remove channel, 21
 - resume time, 40
 - resume, activate, 40
 - start, 21
- self test, 53
- semi duplex, 1
- session
 - keys, 25
 - line, 23
 - status, 24
 - what is, 22

- setup
 - system, 49
 - watch, 40
- simplex, 1
- soft key, 13
 - ALERT, 29
 - DISACK, 33
 - FILTER, 21
 - RELAY, 32
 - TAG, 21
- softer, volume, 10
- speaker volume, 10
- speaking devices, 11
- specifications, 59
- squelch, 15
- squelch control, 2, 10, 15
- squelch knob, 2
- stop
 - replaying a message, 37
 - watch or scan, 20, 21
- support, 53
- system configuration
 - example, 7
- system setup, 49

T

- TAG, 21
 - remove, 21
- tagged channels
 - view, 21
- technical data, 59
- temperature
 - operational, 59, 61
 - storage, 59, 61
- theme
 - color, change, 50
- timeout, 50
 - distress, 45
 - non distress, 45
 - VHF and other non distress, 45

- triple watch
 - change to dual, 20

U

- US channel table, 66
- UTC time
 - enter manually, 12

V

- VHF
 - channels, 18
 - frequency range, 60
- volume
 - louder, 10
 - softer, 10
 - speaker, 10
- volume knob, 2

W

- warnings, 55, 56
- warranty, 58
 - limitation, iv
- WATCH, 20, 21
- watch
 - dual and triple, 20
 - setup, 40
 - start, 20
 - stop, 20
- water ingress, 59
- weather channels, 19
- weight, 61
- working channel, 11

